



Frequency Electronics, Inc.

Tutorial Precision Frequency Generation Utilizing OCXO and Rubidium Atomic Standards with Applications for Commercial, Space, Military, and Challenging Environments

**IEEE Long Island Chapter
March 18, 2004**

Olie Mancini

Vice President, New Business Development

Tel: +516-357-2464

email: oliem@fregelec.com

Acknowledgement:

**Some of the following slides are provided courtesy of Dr. John R. Vig,
U.S. Army Communications-Electronics Command**



Agenda

- **Section 1: Quartz Oscillator Technology**
- **Section 2: Atomic Frequency Standards**
- **Section 3: Applications**
 - Commercial
 - Space
 - GPS
 - Radar
- **Section 4: Breakthrough in Vibration Effects on Clocks Stabilities and Side Bands--Vibration Insensitive Oscillators???**
- **Reference Charts**



Section 1

Quartz Technology



Hierarchy Of Oscillators

Oscillator Type *	Accuracy**	Aging/ 10 year	Radiation Per RAD	Power	Weight
Crystal oscillator (XO)	10^{-5} to 10^{-4}	10-20 PPM	-2×10^{-12}	20 μ W	20 gram
Temperature compensated crystal oscillator (TCXO)	10^{-6}	2-5 PPM	-2×10^{-12}	100 μ W	50 gram
Microcomputer compensated crystal oscillator (MCXO)	10^{-8} to 10^{-7}	1-3 PPM	-2×10^{-12}	200 μ W	100 gram
Oven controlled crystal oscillator (OCXO) - 5 to 10MHz - 15 to 100MHz	10^{-8} 5×10^{-7}	2×10^{-8} to 2×10^{-7} 2×10^{-6} to 11×10^{-9}	-2×10^{-12}	1 – 3 W	200-500 gram
Small atomic frequency standard (Rb, RbXO)	10^{-9}	5×10^{-10} to 5×10^{-9}	2×10^{-13}	6 – 12 W	1500-2500 gram
High Performance atomic standard (Cs)	10^{-12} to 10^{-11}	10^{-12} to 10^{-11}	2×10^{-14}	25 – 40 W	10000-20000 gram

- * Sizes range from <math><5 \text{ cm}^3</math> for clock oscillators to >30 liters for Cs standards.
Costs range from <math><\\$5</math> for clock oscillators to >math> \\$40,000</math> for Cs standards.
- ** Including the effects of military environments and one year of aging.



Raw Quartz to Resonator



- Dynamic Cleaning
- Crystal Cutting i.e. SC, AT, FC, etc
- Rounding
- Contouring
- Polishing
- Plating
- Mounting
- Aging
- Sealing
- Test
- Into Oscillator

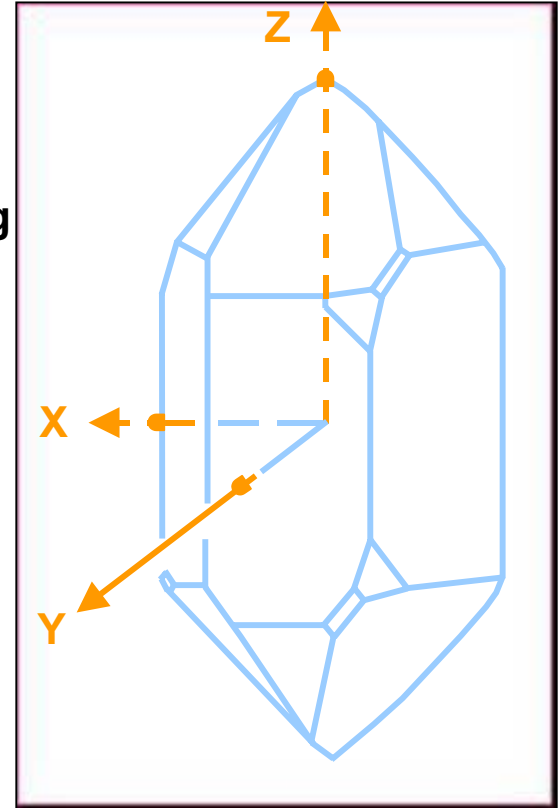

Piezoelectric properties of quartz



Resonator Packaging

Two-point Mount Package

Three- and Four-point Mount Package

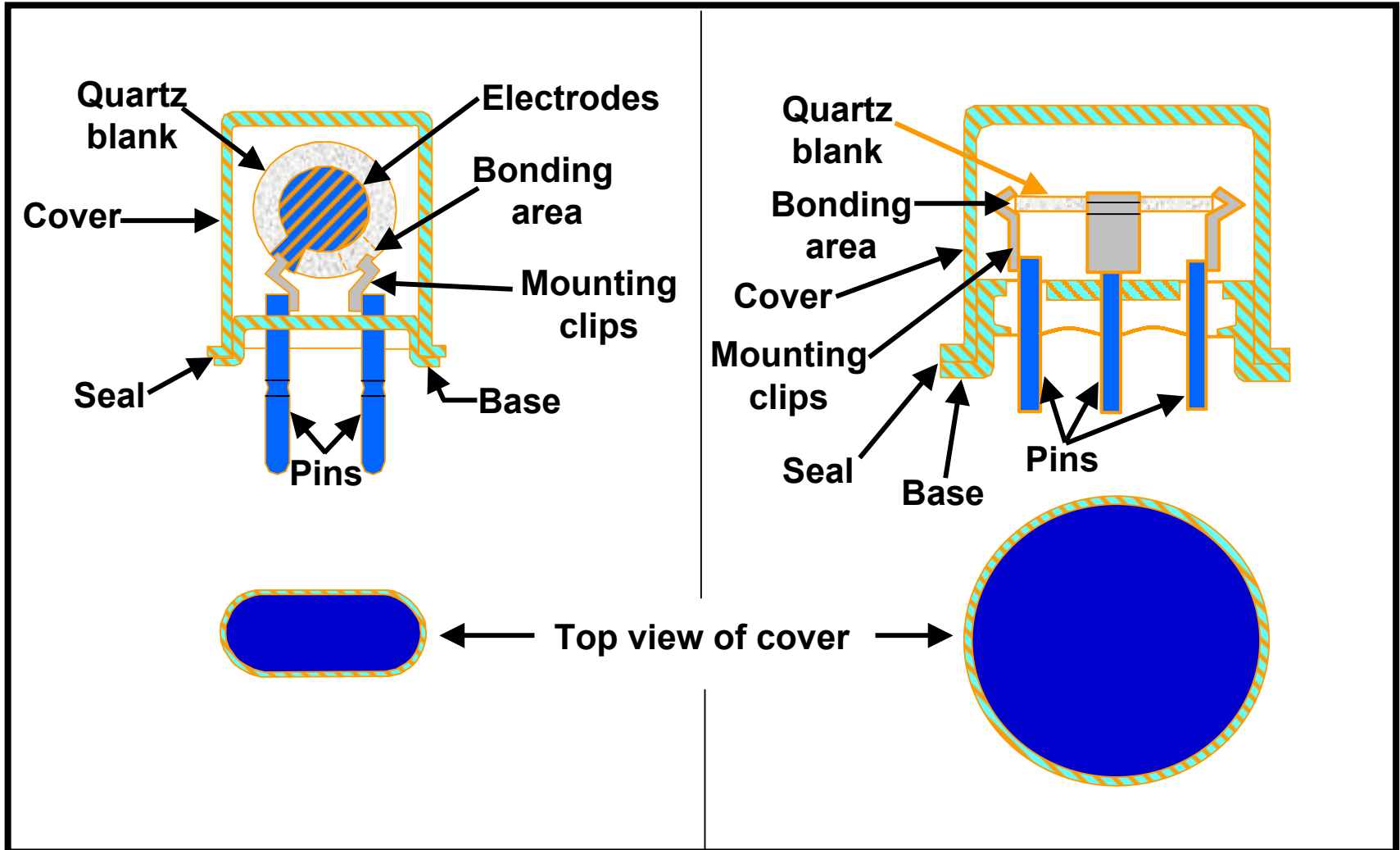



Crystal Technology Mounting Examples

500 MHz, SAW Resonator



10 MHz, 3rd Overtone
SC (Stress-Free) Cut Crystal

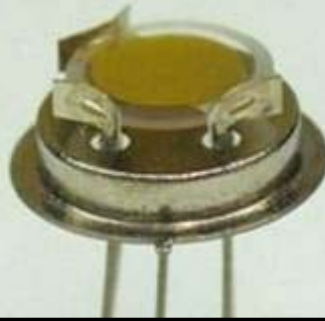

5 MHz, 5th Overtone
SC (Stress-Free) Cut Crystal



5 MHz, 3rd Overtone Crystal



Split Ring Resonator





Crystallographic Axes

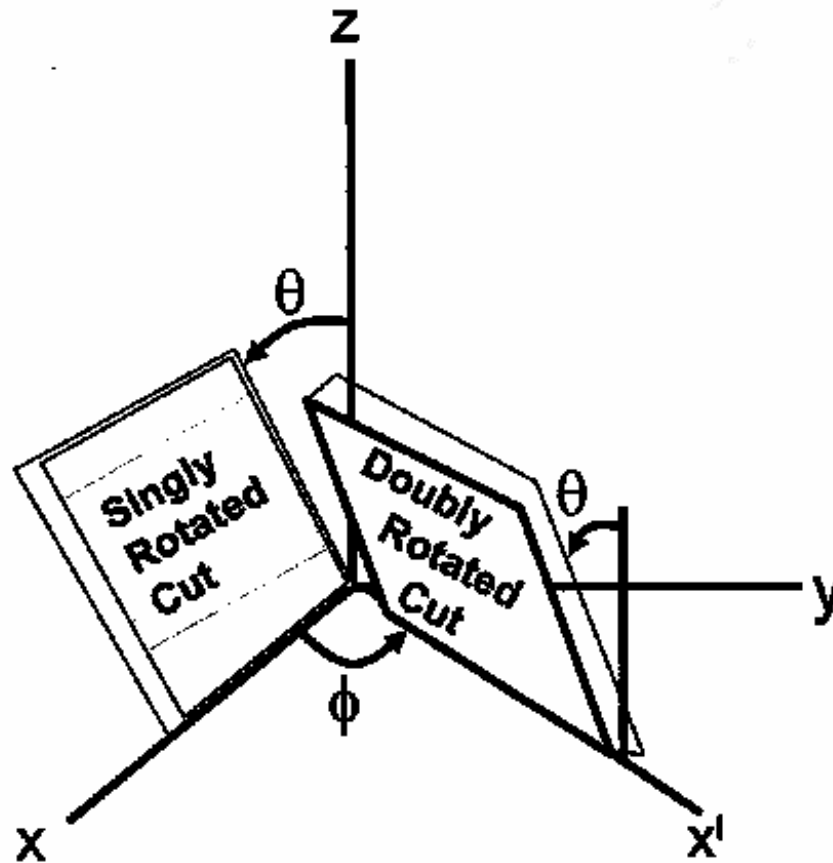



SC-Cut 21.93°

Frequency-Temperature vs. Angle-of-Cut

$\Delta\theta$

Frequency-Temperature vs. Angle-of-Cut, AT-cut

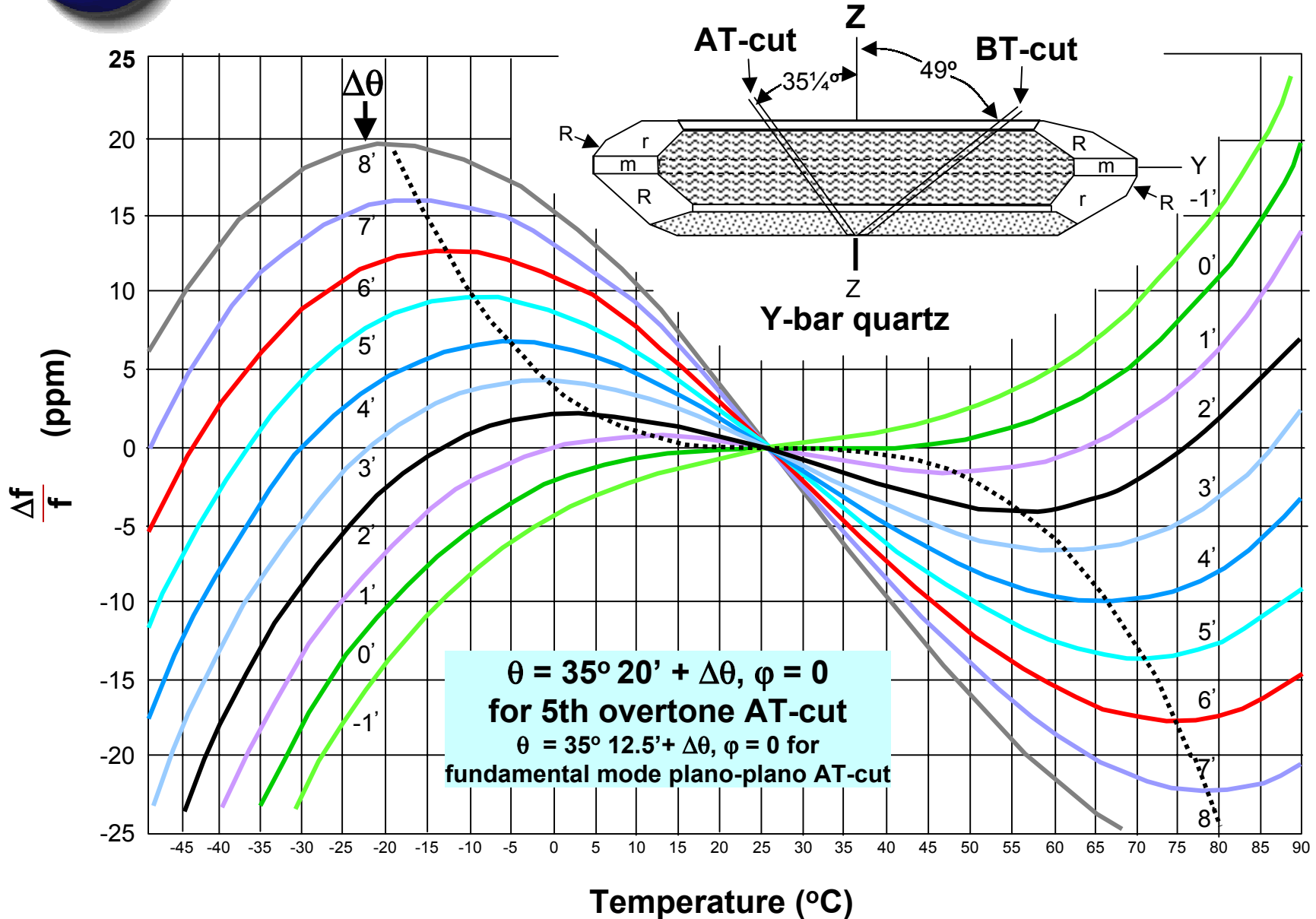



Sealing



■ Sealing

- For precision oscillators cleanliness and purity is extremely important, and sealing takes place in atmospheric chambers down to $1\text{E-}9$ Tor, and requires about 18 hours of pumping to achieve this atmospheric level

■ Testing



Typical Crystal Oscillator

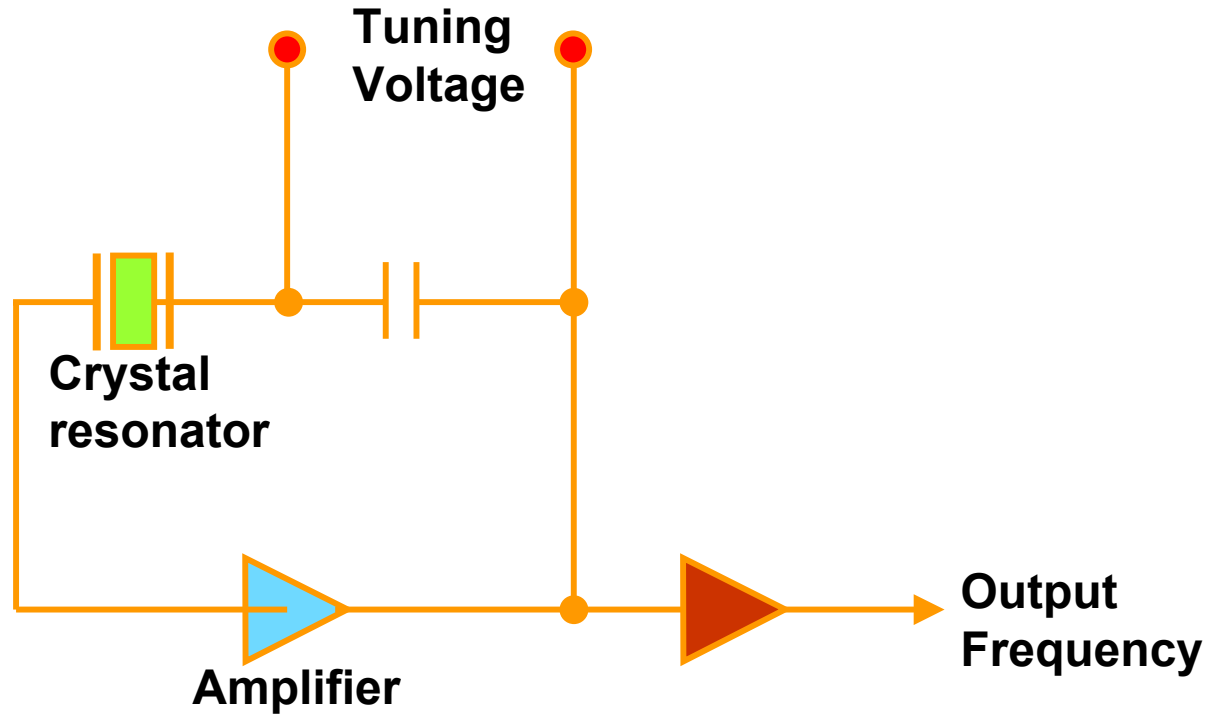



Into Oscillators

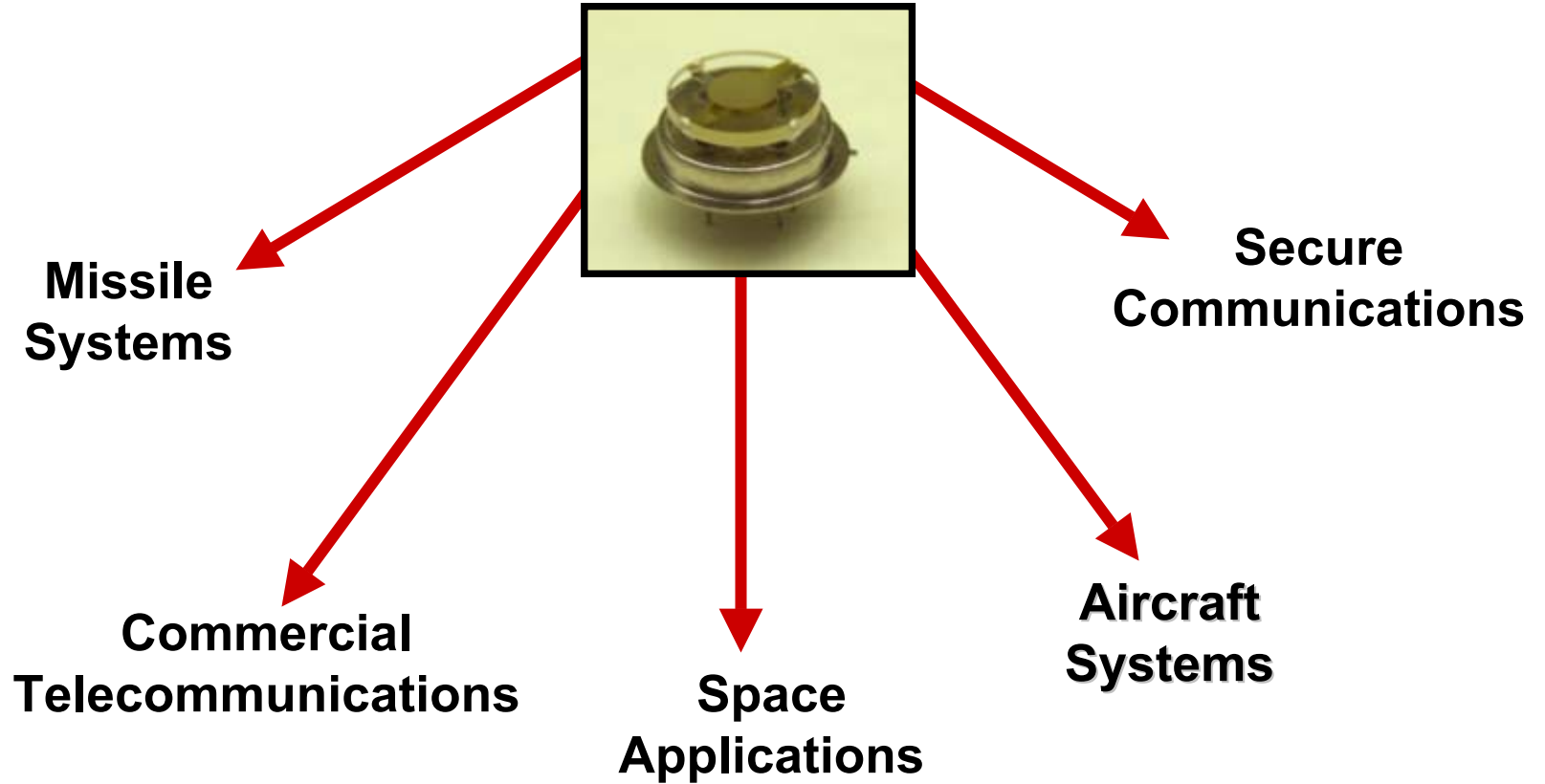



Accuracy, Precision, and Stability

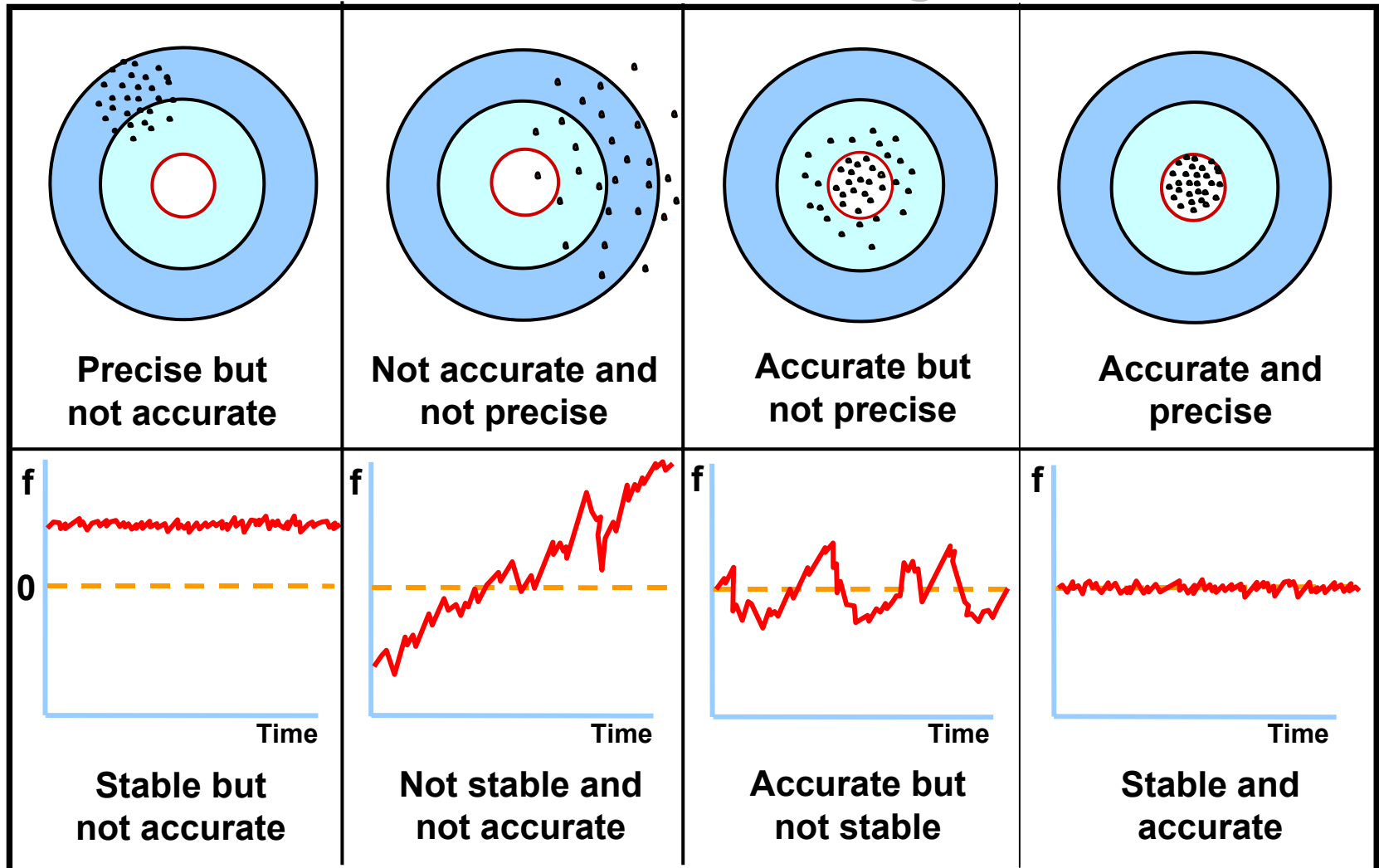



Oscillator Stability

- **Definitions:**

- $1 \times 10^{-10} = 1\text{E}-10 = 1\text{e}^{-10} = 1/10,000,000,000 = .000\ 000\ 000\ 1$ or $0.1 \times 10^{-9} = 0.1\text{ppb}$.

- Example: An Accuracy of 1×10^{-10} at 10MHz affects the frequency as shown on a sensitive freq meter

10,000,000.001

Note that the milli-Hertz position is affected

- **What Affects Oscillator Stability?**

- Aging
 - Temperature
 - Radiation
 - Vibrations



Typical Aging Behaviors

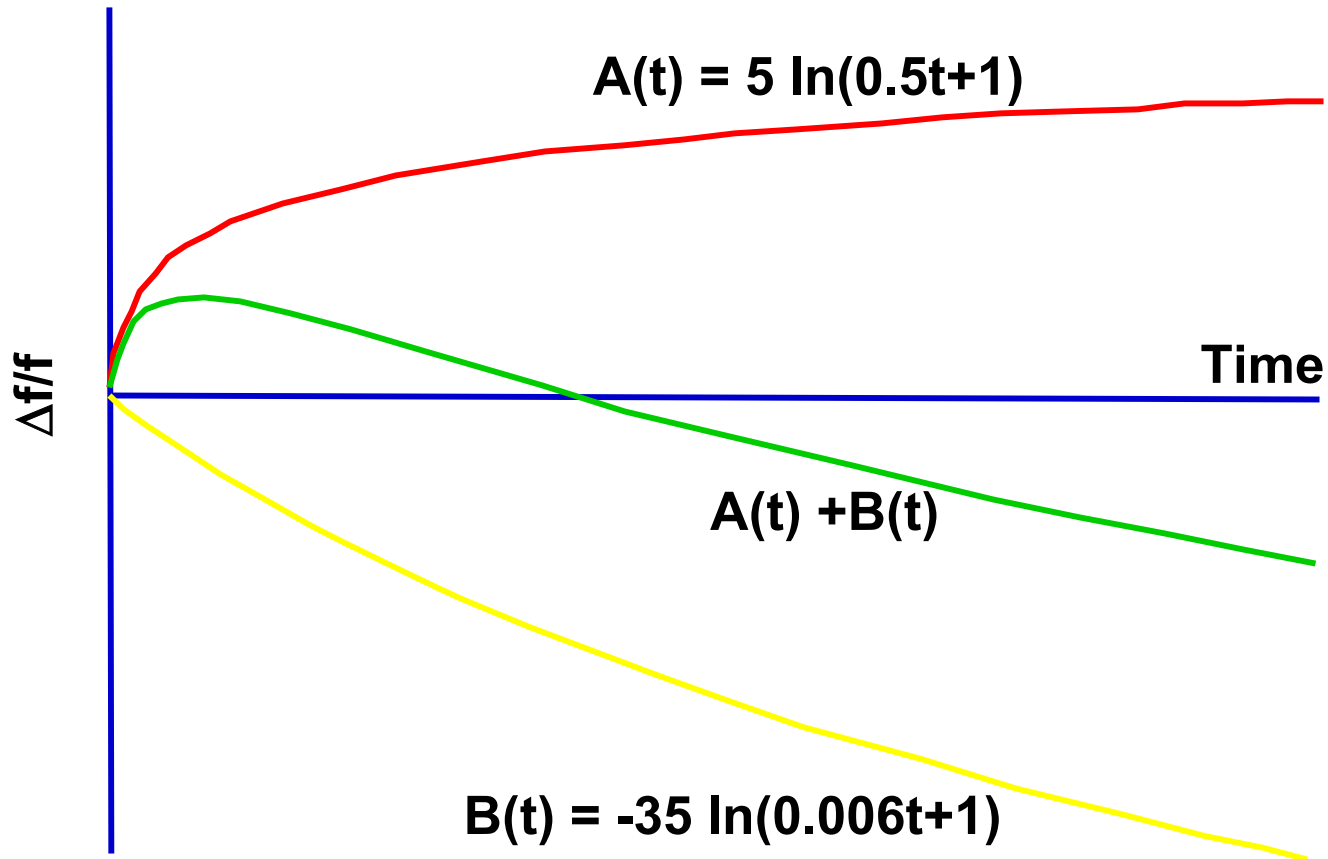



Aging Mechanisms

- **Mass transfer due to contamination**

Since $f \propto 1/t$, $\Delta f/f = -\Delta t/t$; e.g., $f_{5\text{MHz}} \approx 10^6$ molecular layers, therefore, 1 quartz-equivalent monolayer $\Rightarrow \Delta f/f \approx 1$ ppm

- **Stress relief in the resonator's: mounting and bonding structure, electrodes, and in the quartz (?)**

- **Other effects**

- Quartz outgassing
- Diffusion effects
- Chemical reaction effects
- Pressure changes in resonator enclosure (leaks and outgassing)
- Oscillator circuit aging (load reactance and drive level changes)
- Electric field changes (doubly rotated crystals only)
- Oven-control circuitry aging



QUARTZ CRYSTAL THICKNESS AS A FUNCTION OF CUT

$$f = AK/t$$

$$t = AK/f$$

f = Frequency in MHz

A = Overtone (1, 3, 5, 7)

K = A constant (Mils)

t = Thickness in Mils

$K_{AT} = 65.5$ Mils

$K_{FC} = 68$ Mils

$K_{SC} = 72.3$ Mils

e.g.: **$t = \frac{1 \times 65.5}{1} = 65.5$ mils thick for an AT cut Fundamental 1MHz crystal**

- **THICKNESS SHEAR QUARTZ RESONATORS ARE PREDOMINANTLY USED FOR MOST HIGH PRECISION QUARTZ APPLICATIONS.**
- **THE MOST USEFUL QUARTZ CRYSTAL CUTS ARE THE AT, FC AND SC.**
- **THE THICKEST QUARTZ BLANK SHOULD BE USED AT THE HIGHEST PRACTICAL OVERTONE FOR BEST AGING AND RETRACE PERFORMANCE.**



CRYSTAL AGING vs RESONATOR THICKNESS

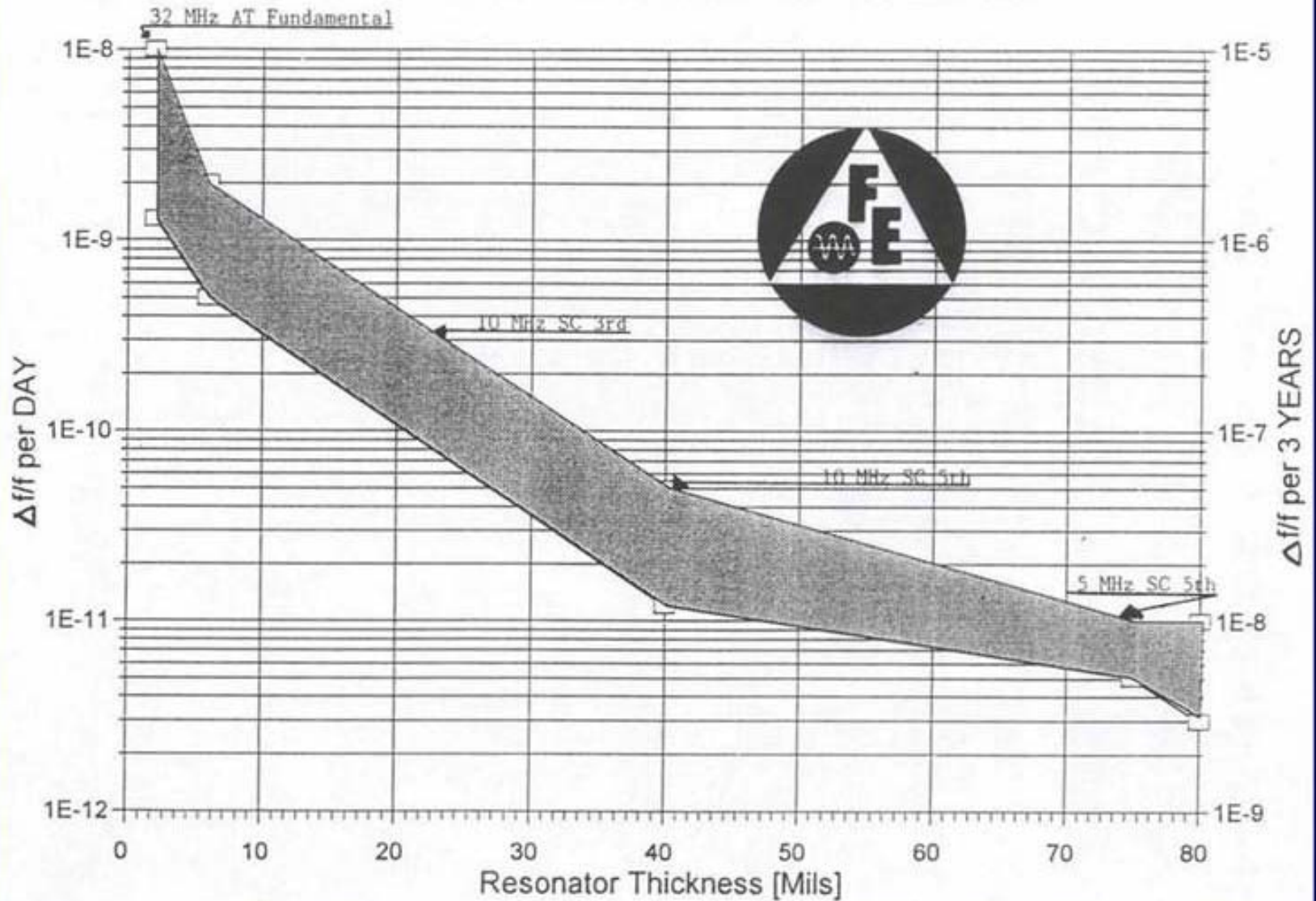



Typical Aging Plot

Aging per day

$$18 \times 10^{-10} / 21 \text{ weeks} \times 7 \text{ days}$$

$$\approx 1.2 \times 10^{-11}$$

Aging after 10 years linear approximation

$$(1.2 \times 10^{-11}) (365 \text{ days}) (10 \text{ year})$$

$$\approx 4.38 \times 10^{-8}$$

$$\tau^{1/2} \approx (4.38 \times 10^{-8}) / 2 \approx 2 \times 10^{-8}$$

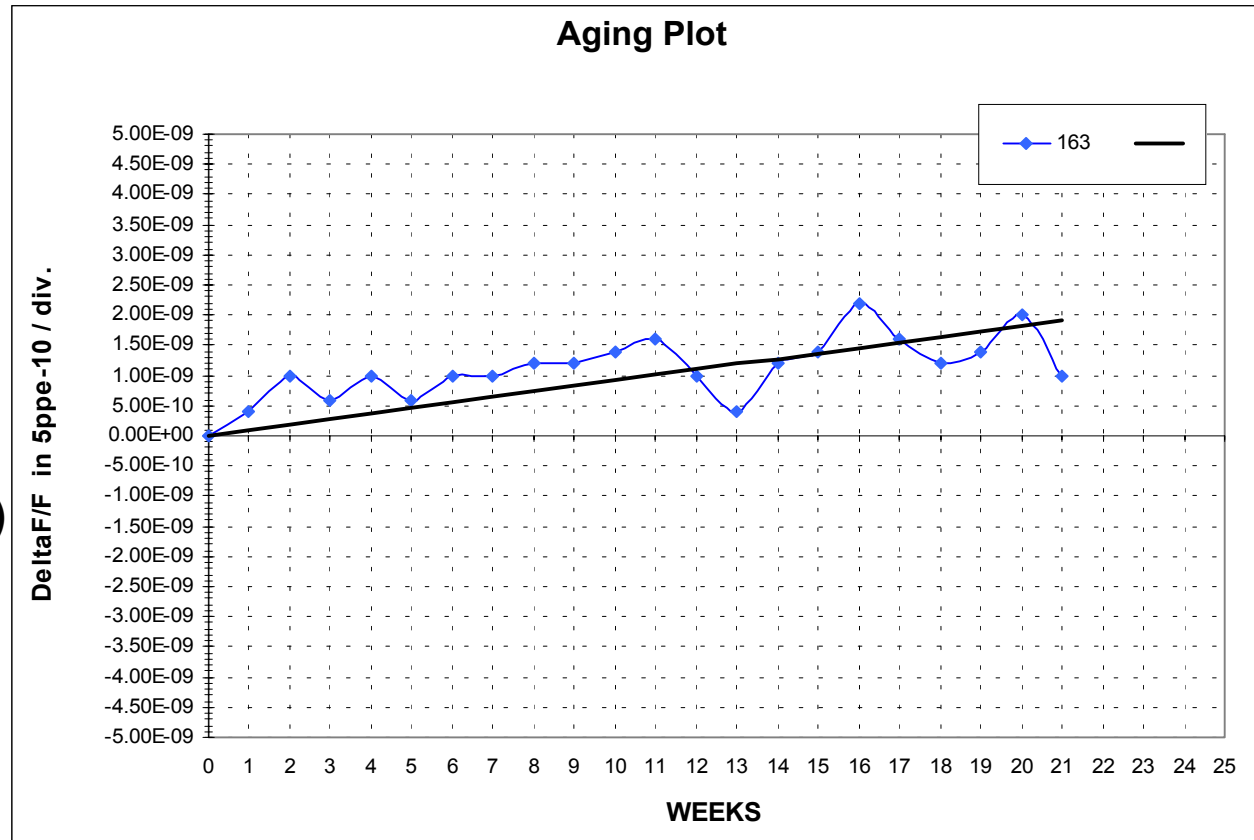



Temperature Effects

- **Crystal must be maintained at constant temperature over entire operating range**
 - Operating range may be from -40°C to $+85^{\circ}\text{C}$
 - The more precise is the oven the better is the temperature coefficient

- **Precision ovens are constructed around the resonator and insulation is added around the oven to maintain a more uniform temperature gradient**

- **Ovens come in different sizes and shapes**
 - Single oven
 - Double oven
 - Ovens in Dewar Flasks for super precision



Frequency vs. Temperature Characteristics

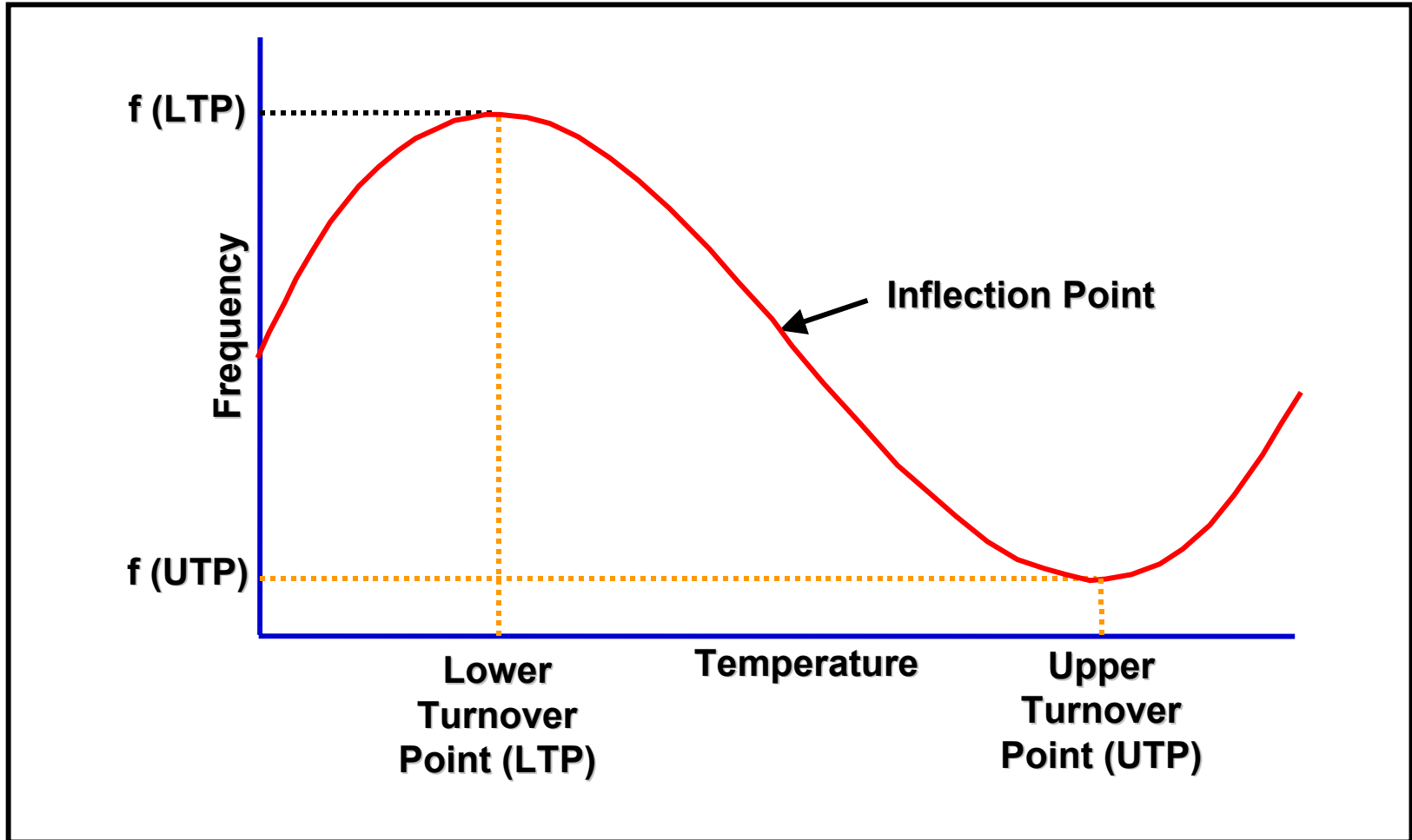



Example of Super Precise Double Oven OCXO (FE-205A Series)



**2"W x 2"L x 1.5"H
For Through Hole Package**



**3"W x 3"L x 1.4"H
For Rubidium Package**



***Example:
Effects of Aging and
Temperature on a
10 MHz Quartz Oscillator***



Example: Stability vs. Aging

- **Example: Aging Rate or Drift**

- 10 MHz oscillator ages at $\pm 5.1 \times 10^{-9}$ /day (oscillator frequency may be expected to change by that amount per day times the number of days involved...WORSE CASE)

- The measured frequency output after 1 days of operation could read:

$(10,000,000)(\pm 5.1 \times 10^{-9})(1 \text{ days}) = \pm 0.051 \text{ Hz of } 10 \text{ MHz or between}$

$10,000,000 + 0.051 = 10,000,000.051 \text{ Hz and}$

$10,000,000 - 0.051 = 9,999,999.049 \text{ Hz}$



Example: Temperature Effects

■ Temperature effects

– Assumptions:

- 10 MHz oscillator that operates from -20° C to +70° C and exhibits a frequency stability of 2×10^{-9} (temperature coefficient).
- Oscillator will be used in an environment where the temperature varies only from -5° C to +50° C.

– The frequency error is calculated as follows:

$$\begin{aligned} \text{Temp Coeff per } ^\circ\text{C} &= \text{Temp Coeff /total temperature range} \\ &= 2 \times 10^{-9} / 90 ^\circ\text{C} = 2.2 \times 10^{-11} / ^\circ\text{C} \end{aligned}$$

$$\text{Error (-5}^\circ\text{C to +50}^\circ\text{C)} = (2.2 \times 10^{-11} / ^\circ\text{C})(55^\circ\text{C}) = 1.2 \times 10^{-9}$$

$$\text{Freq Error} = (10,000,000)(1.2 \times 10^{-9}) = .012 \text{ Hz} = 10,000,000.\underline{012}$$



Total Error Due to Aging and Temperature

- **Total Error: Two major components**
 - Linear Drift (fractional frequency drift rate per day or F') = 0.051
 - Temperature (fractional frequency offset or $\Delta f/f$) = 0.012
 - Total Frequency error = 0.063 Hz
- **Or calculate a one day error as follows:**
 - Drift (F') = 5.1×10^{-9}
 - Temp ($\Delta f/f$) = 1.2×10^{-9}
 - Total Error at end of 24 hrs = 6.3×10^{-9}
 - Effect on Freq: $(10,000,000)(6.3 \times 10^{-9}) = 0.063 \text{ Hz} = 10,000,000.063$
- **Translate into accumulated time error:**
 - For Linear Drift Rate Δt (in μsec) = $(4.32 \times 10^{10})(F' \text{ per day})(\text{Days})^2$
= $(4.32 \times 10^{10})(5.1 \times 10^{-9})(1)^2 = 220 \mu\text{sec}$
 - For Linear Temper Δt (in μsec) = $(8.64 \times 10^{10})(\Delta f/f)(\text{Days})$
= $(8.64 \times 10^{10})(1.2 \times 10^{-9})(1) = 103 \mu\text{sec}$
 - Total accumulated time error in a day = $220 + 103 = \underline{323 \mu\text{sec}}$
- **See Charts at end of presentation to easily determine accumulated time error**



DSP-1 OCXO PROTOQUAL UNIT LOW LEVEL RADIATION TEST

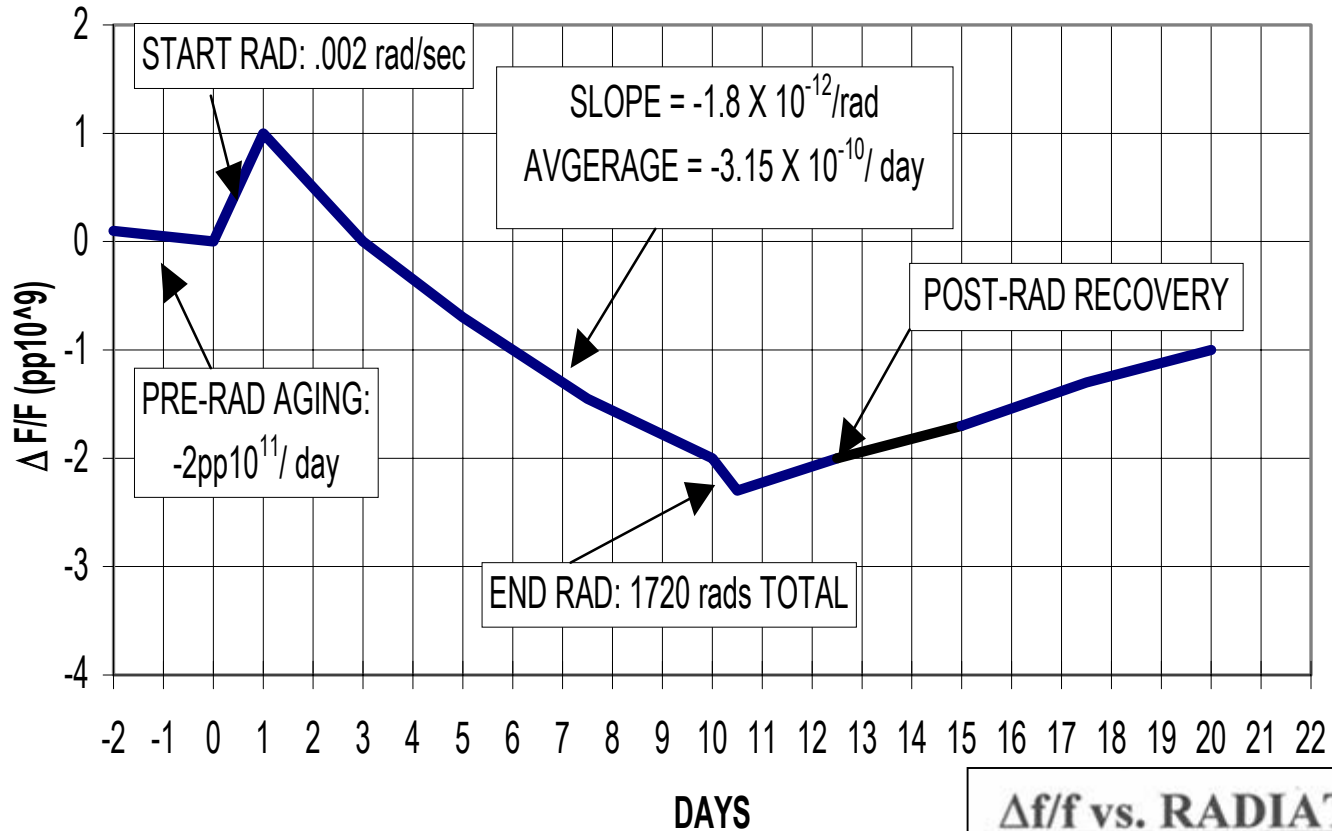

$\Delta f/f$ vs. RADIATION

- $\approx -1 \times 10^{-12}$ / rad
- ≈ 6 rads / day
- -0.6×10^{-11} / day

Effects of Radiation on Aging



OCXO Retrace

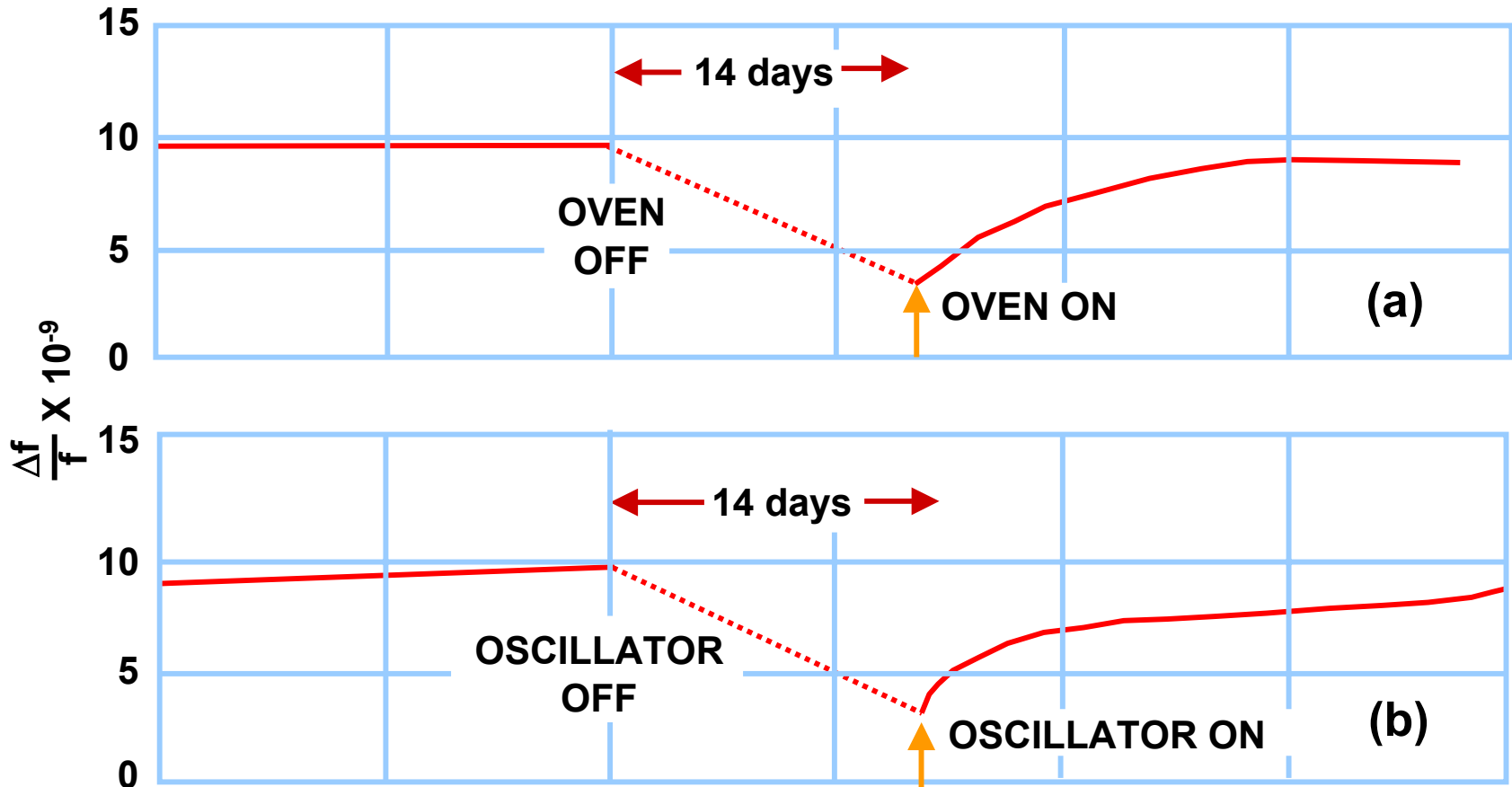

In (a), the oscillator was kept on continuously while the oven was cycled off and on. In (b), the oven was kept on continuously while the oscillator was cycled off and on.



Frequency Jumps

Unexplainable Oscillator Phenomenon

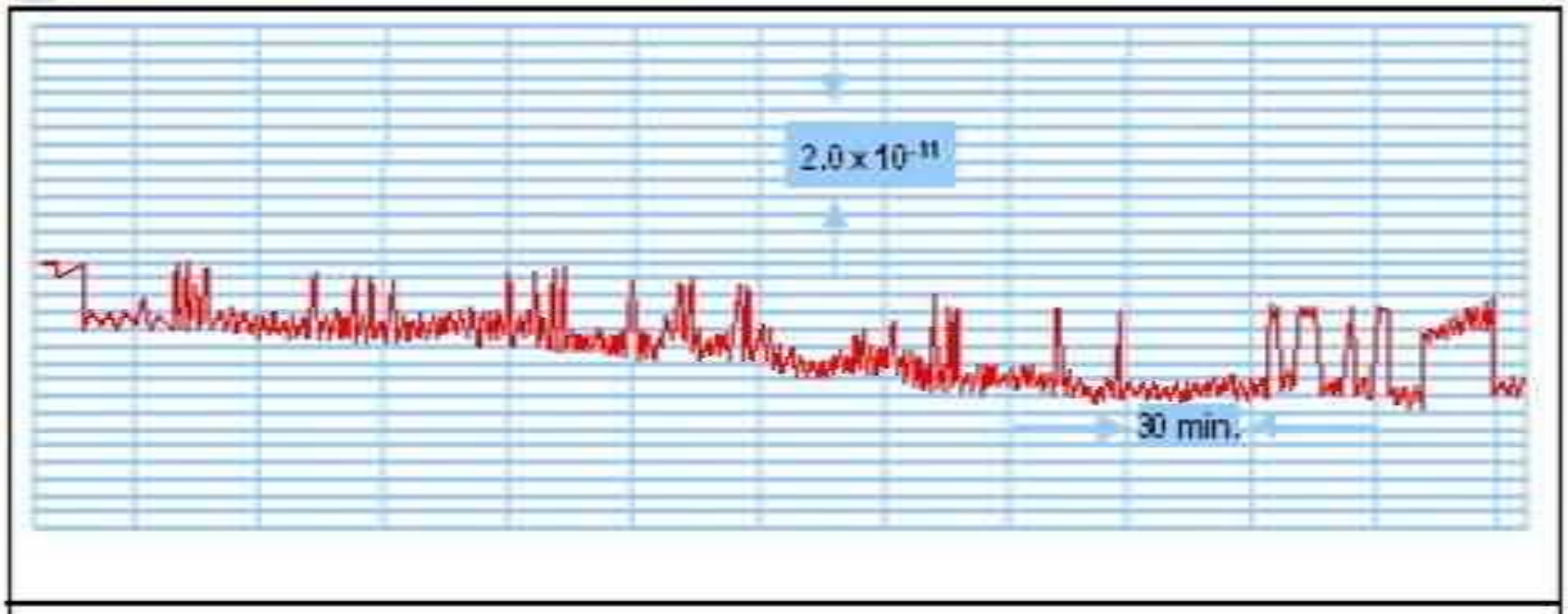

Frequency jumps occur in oscillators--in some many times a day in others less frequent.

Magnitude of jumps in precision oscillators are typically in the range of 10^{-11} to 10^{-9} .

The frequency excursion can be positive or negative.



Noise in Crystal Oscillators

- **The resonator is the primary noise source close to the carrier; the oscillator sustaining circuitry is the primary source far from the carrier.**
- **Frequency multiplication by N increases the phase noise by N^2 (i.e., by $20\log N$, in dB's).**
- **Vibration-induced "noise" dominates all other sources of noise in many applications (acceleration effects discussed later).**



Types of Phase Noise

$\mathcal{L}(f_f)$

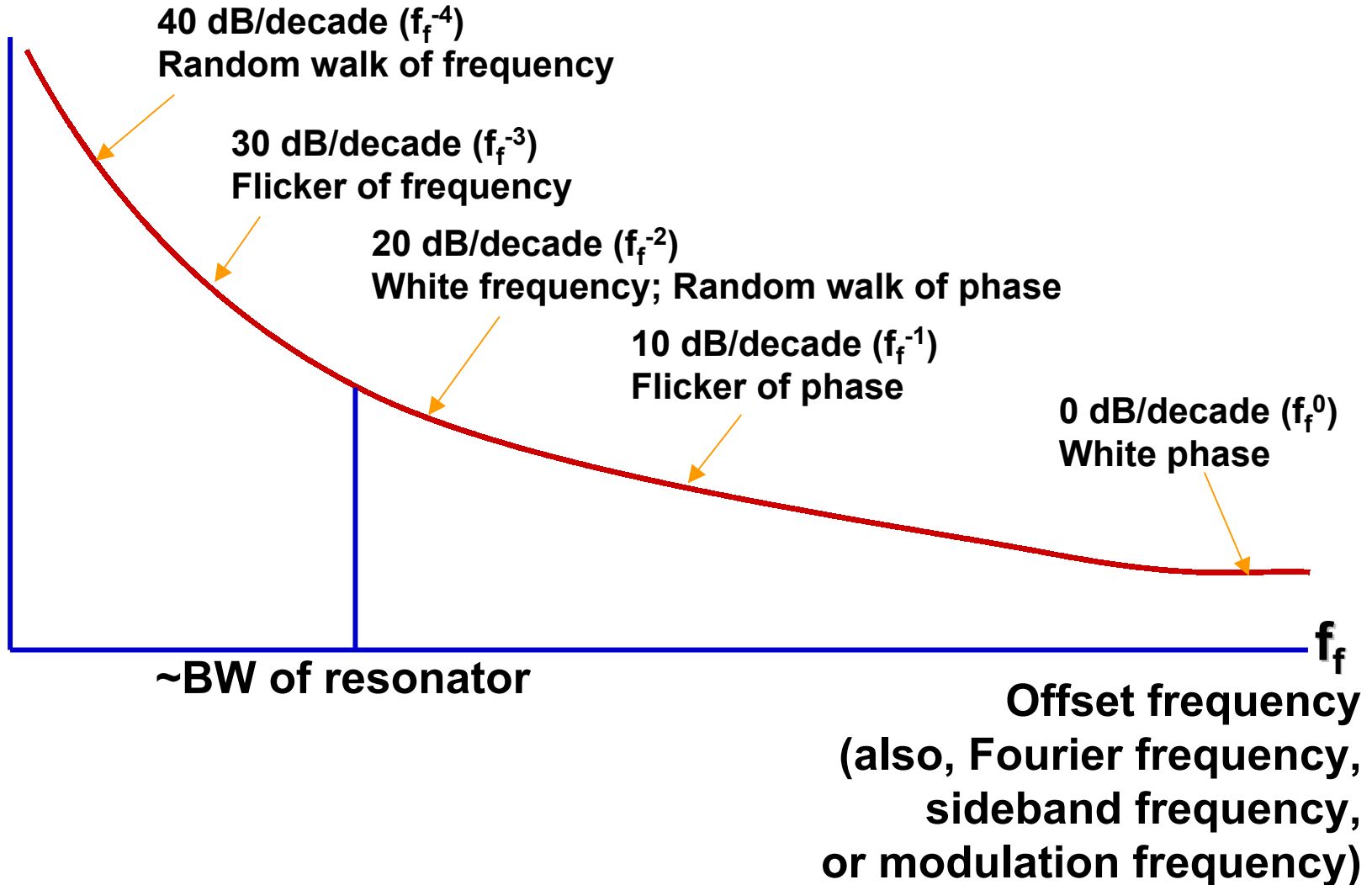



Example of Super Low Noise 100 MHz Quartz Oscillator

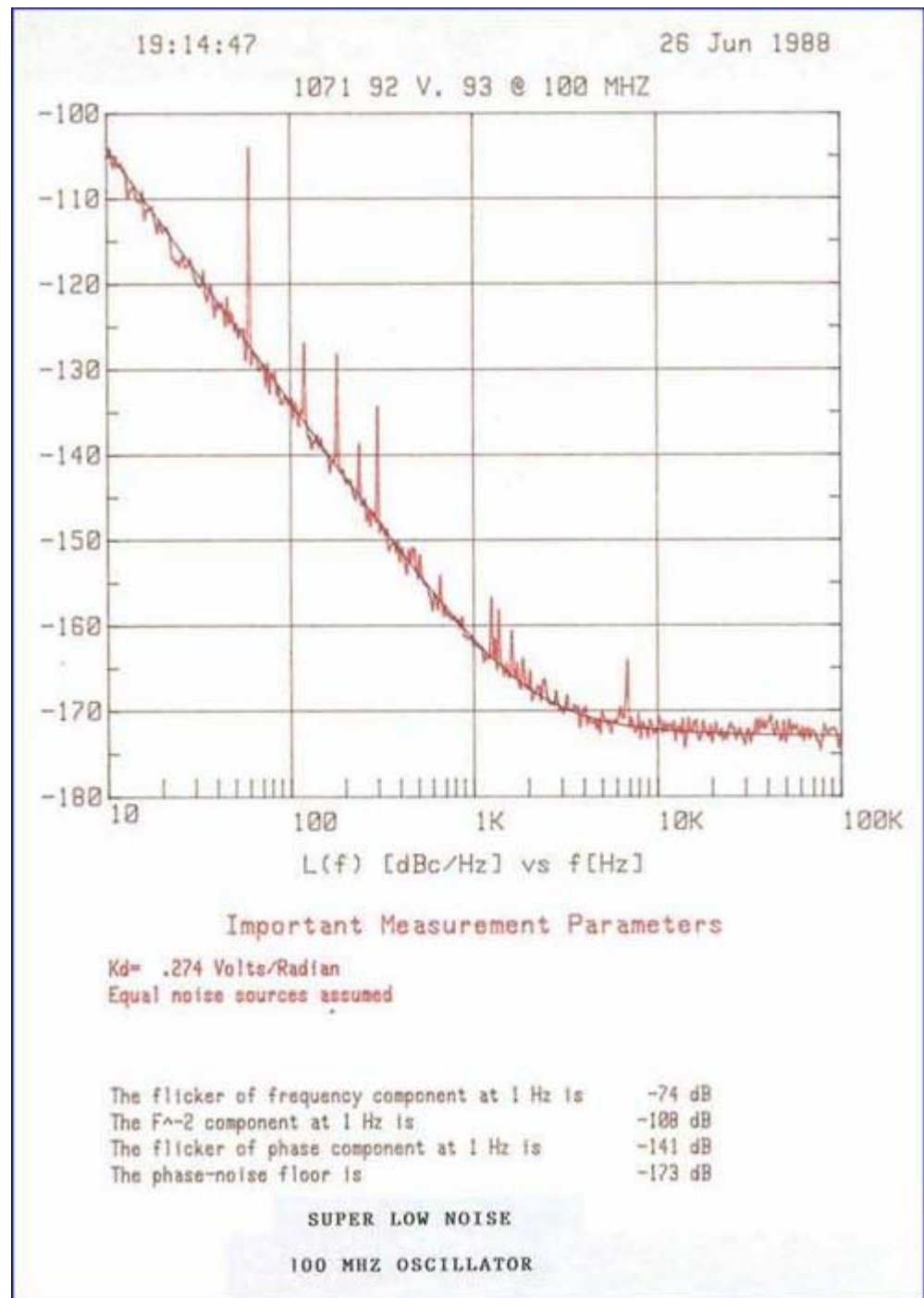



Section 2

Atomic Frequency Standards



Atomic Frequency Standard Basic Concepts

When an atomic system changes energy from an excited state to a lower energy state, a photon is emitted. The photon frequency ν is given by Planck's law

$$\nu = \frac{E_2 - E_1}{h}$$

where E_2 and E_1 are the energies of the upper and lower states, respectively, and h is Planck's constant. An atomic frequency standard produces an output signal the frequency of which is determined by this intrinsic frequency rather than by the properties of a solid object and how it is fabricated (as it is in quartz oscillators).

The properties of isolated atoms at rest, and in free space, would not change with space and time. Therefore, the frequency of an ideal atomic standard would not change with time or with changes in the environment. Unfortunately, in real atomic frequency standards: 1) the atoms are moving at thermal velocities, 2) the atoms are not isolated but experience collisions and electric and magnetic fields, and 3) some of the components needed for producing and observing the atomic transitions contribute to instabilities.



Generalized Atomic Resonator

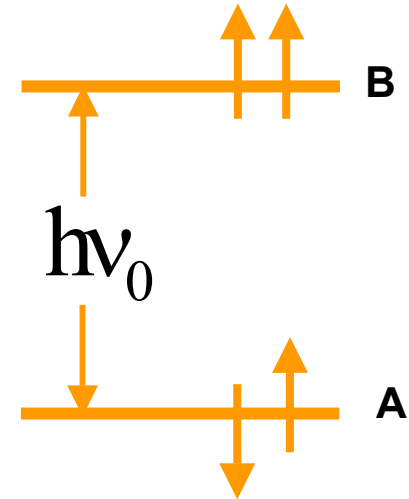
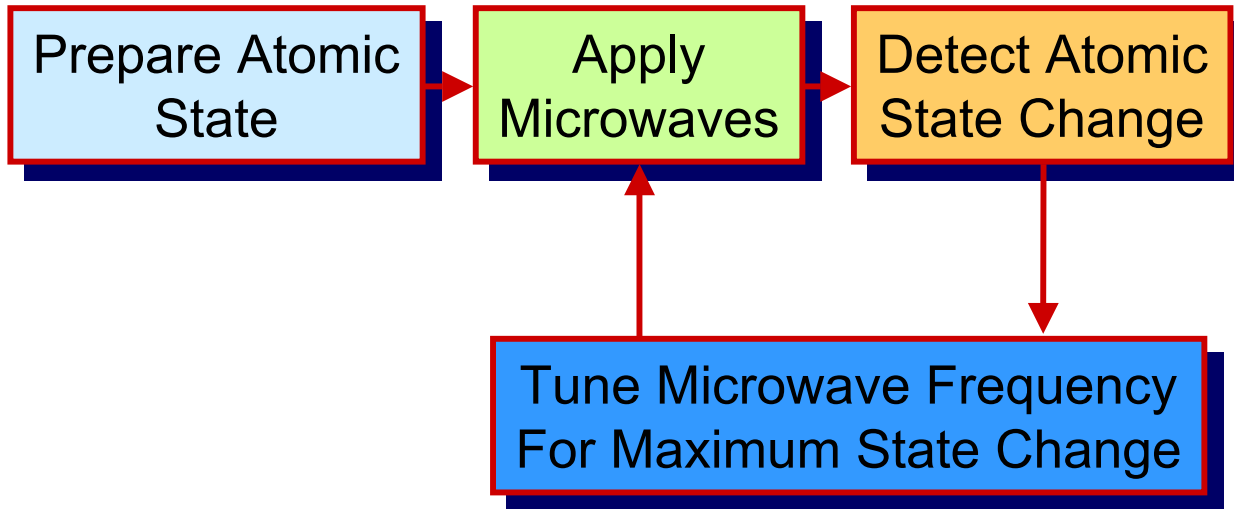



Atomic Frequency Standard Block Diagram

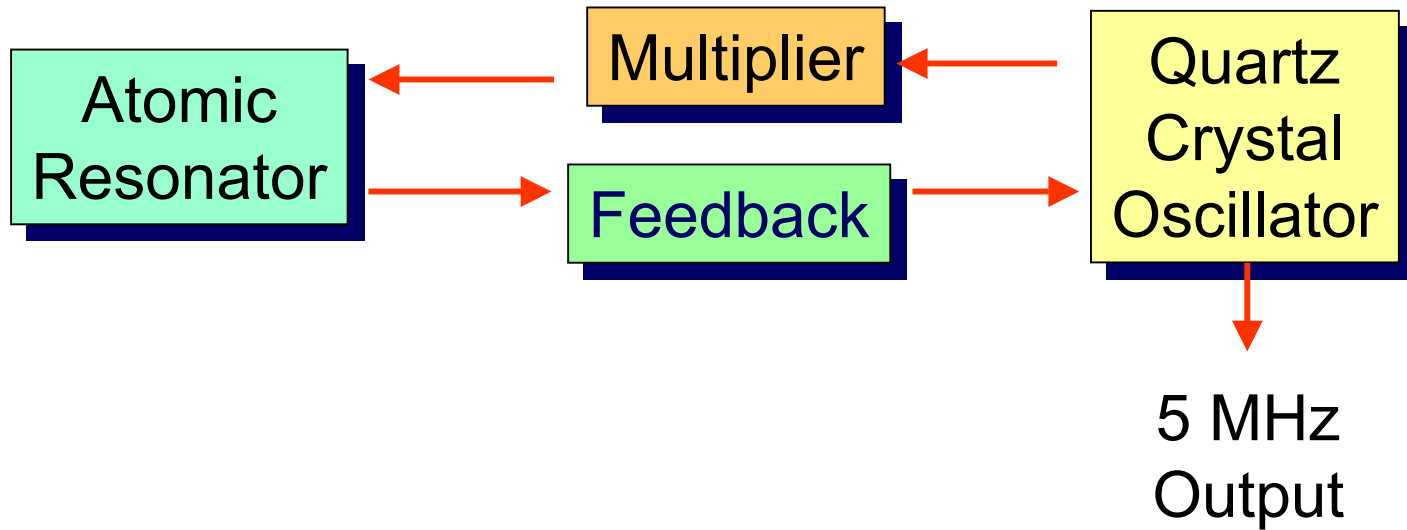



Rubidium Cell Frequency Standard

Energy level diagrams of ^{85}Rb and ^{87}Rb

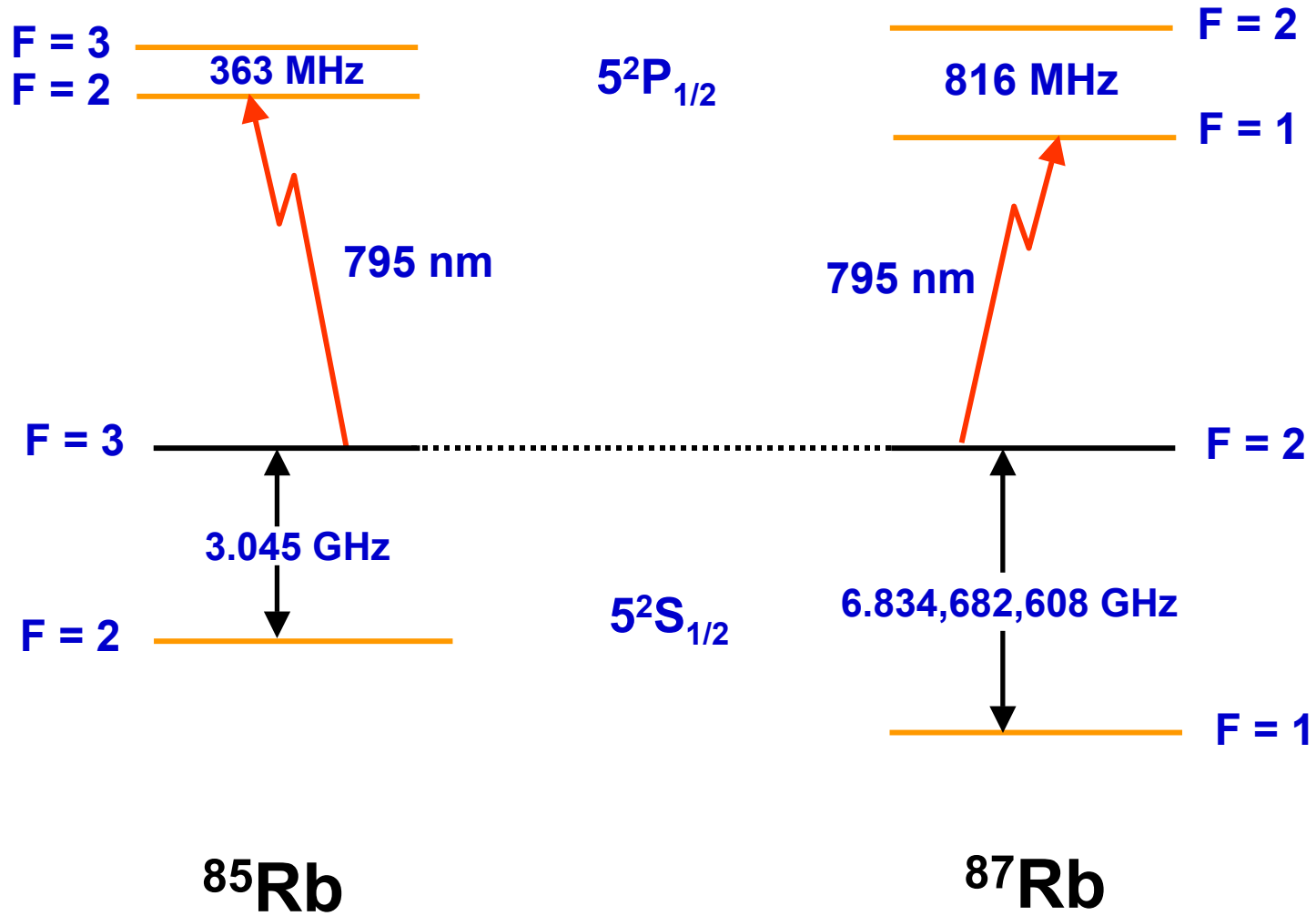



Rubidium Cell Frequency Standard

Atomic resonator schematic diagram

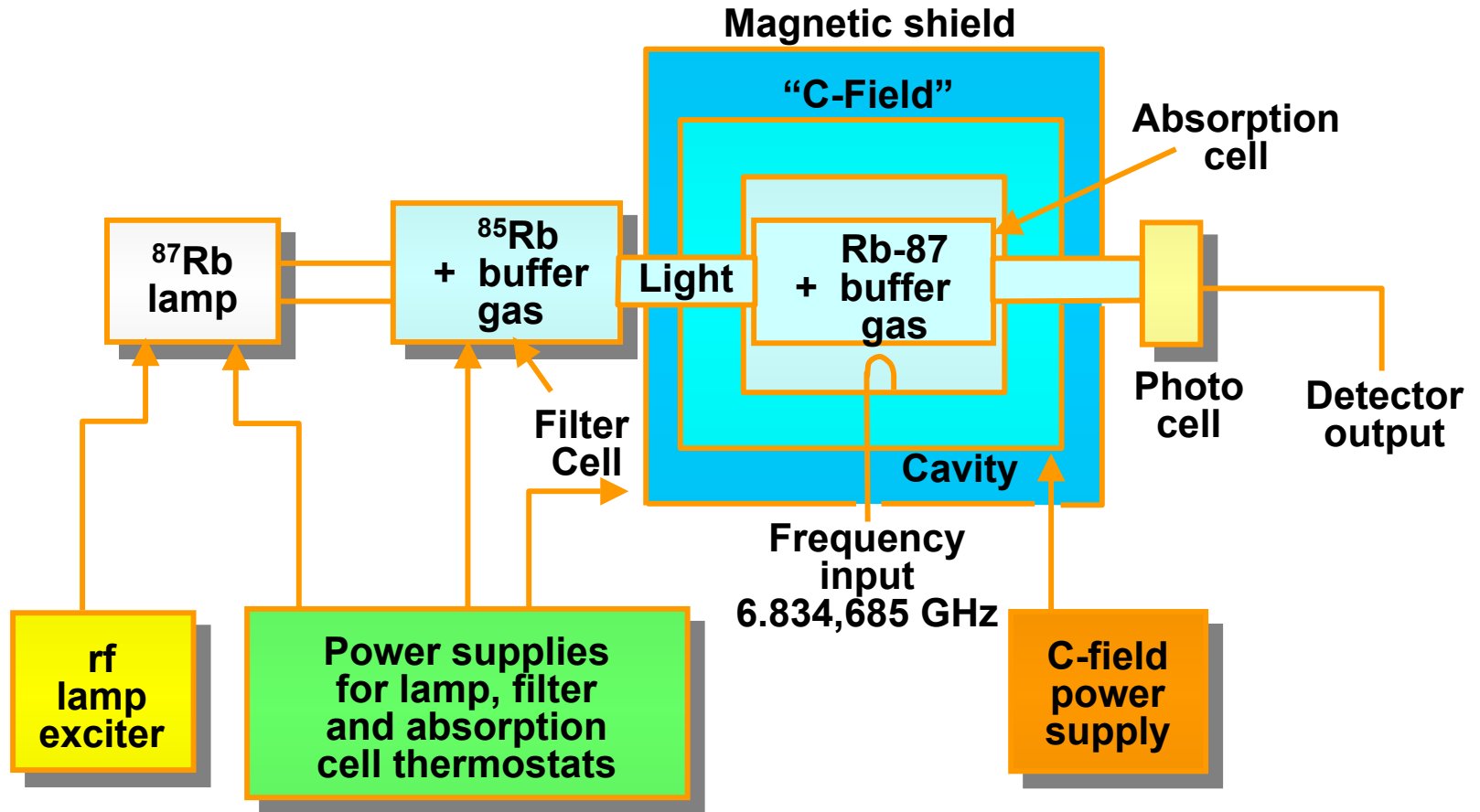



Rubidium Atomic Standards



**Wireline and Wireless
Applications
Space Time Keeping**

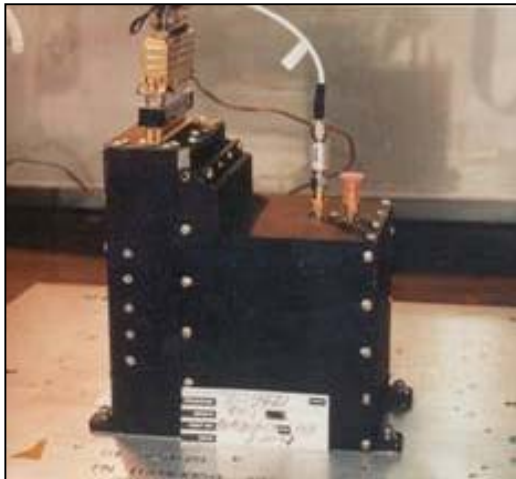
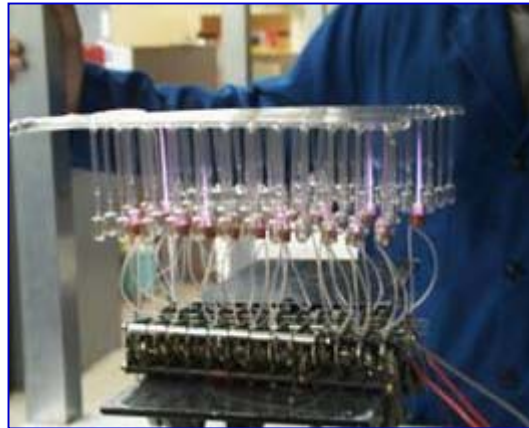
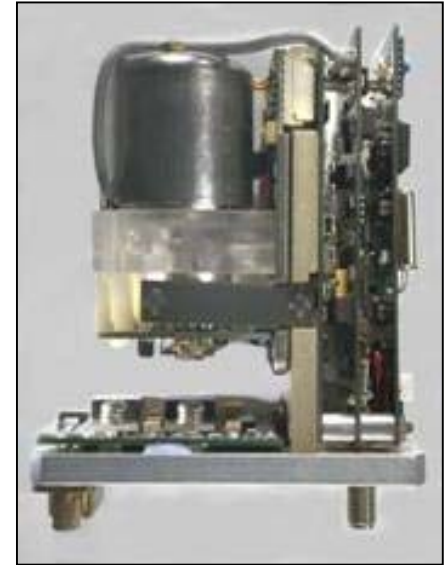

**Airborne and Ground-Base
Radar Applications**





Example of Rubidium Standard FE-5650 Series



3"

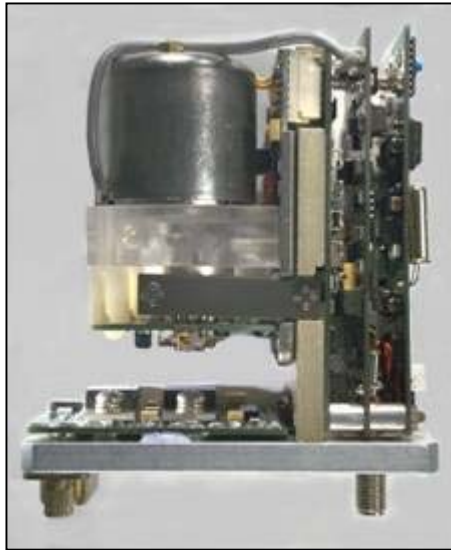

Size: 3x3x1.4 in.

Digitally Programmable

Frequency: 1 Hz to 20 MHz or other desirable frequency

**Freq. Vs. Temp.
(from -55 to +85°C)**

From $\pm 3 \times 10^{-10}$ to $\pm 5 \times 10^{-11}$



Example of Rubidium Standard FE-5680 Series

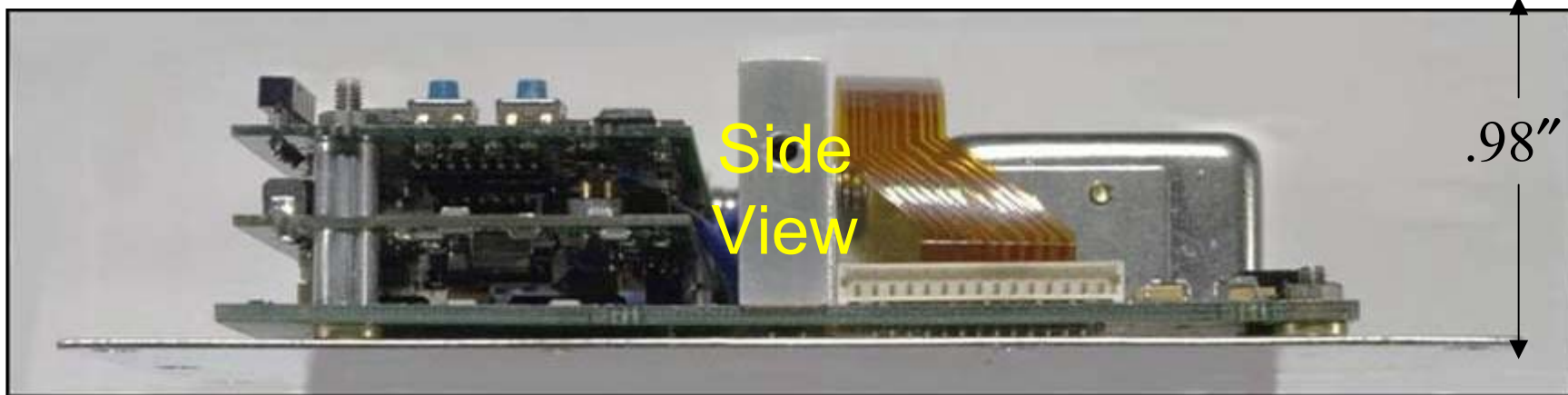



Rubidium Capabilities

- **Frequency** Typical 5 MHz, 10MHz, 20 MHz
- **Aging** 10 Year No Adjustment Operation $<1 \times 10^{-9}/10\text{Years}$
- **Settability** (1.5×10^{-12} Steps) Range: 2×10^{-7}

- **Allan Variance** $5 \times 10^{-12}/\sqrt{\tau}$
- **Input Voltage Sensitivity** $\leq 4 \times 10^{-12}$
- **Frequency Vs Temperature** 1×10^{-10} to 7×10^{-11} ($-55^{\circ}\text{C} - +85^{\circ}\text{C}$)
- **Temperature** 1×10^{-10} (-55°C To $+95^{\circ}\text{C}$) Temperature Compensated with TEC

- **Input Voltage** Standard Voltages (+15 V To +50v) (-15v To -70v)
- **Packaging** Configurable
- **Package Size** Various



Examples of Cesium Clocks

**Spacecraft Cesium Clocks Units
flown on GPS I sponsored by
USNRL**

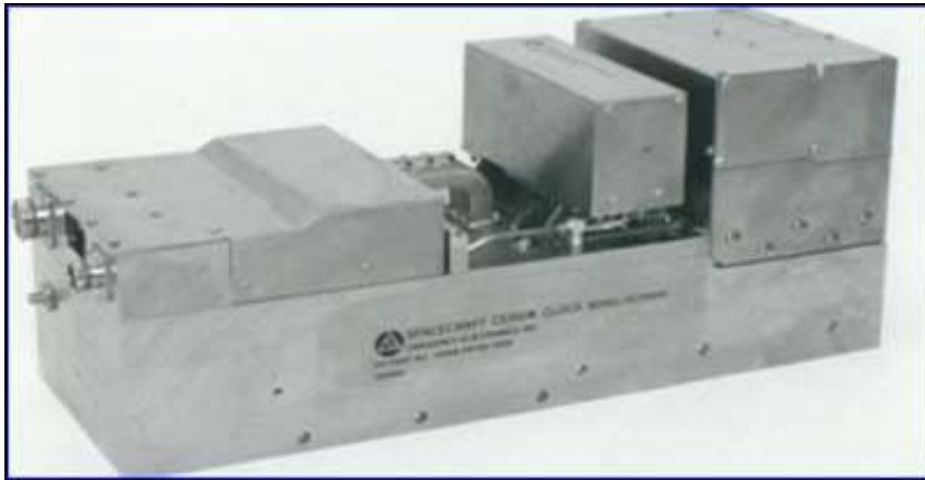

**Vibration Isolated Cesium Standard
for Low Noise Aircraft Applications**

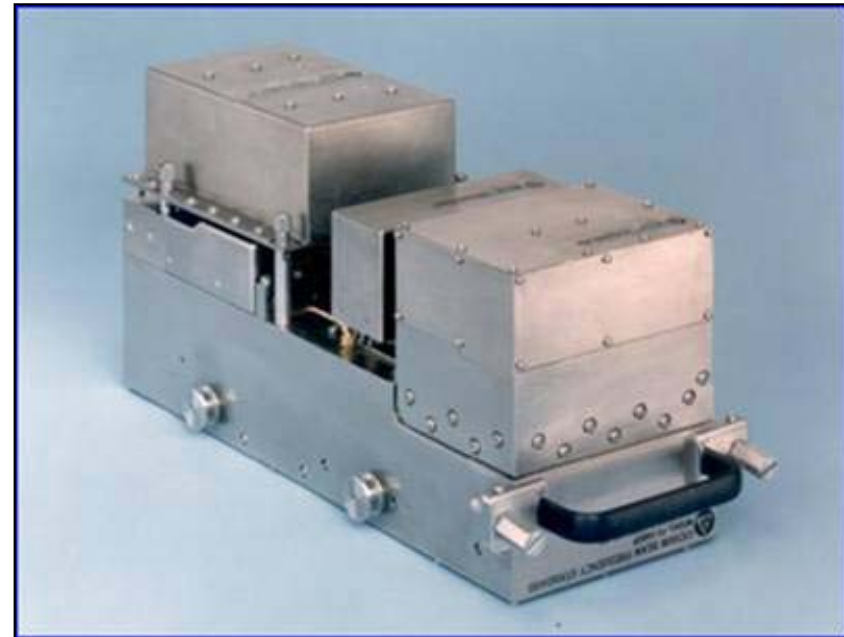



Passive Hydrogen Maser

*Passive Hydrogen Maser Frequency and Time Standard
model VCH-1006*



- Small size hydrogen maser less than 30 kg weight
- Fine frequency and time stability $5 \times 10^{-13}/s$ and $5 \times 10^{-15}/\text{day}$
- Full digital data monitoring and functions control (local or remote)
- Lifetime – 20 years

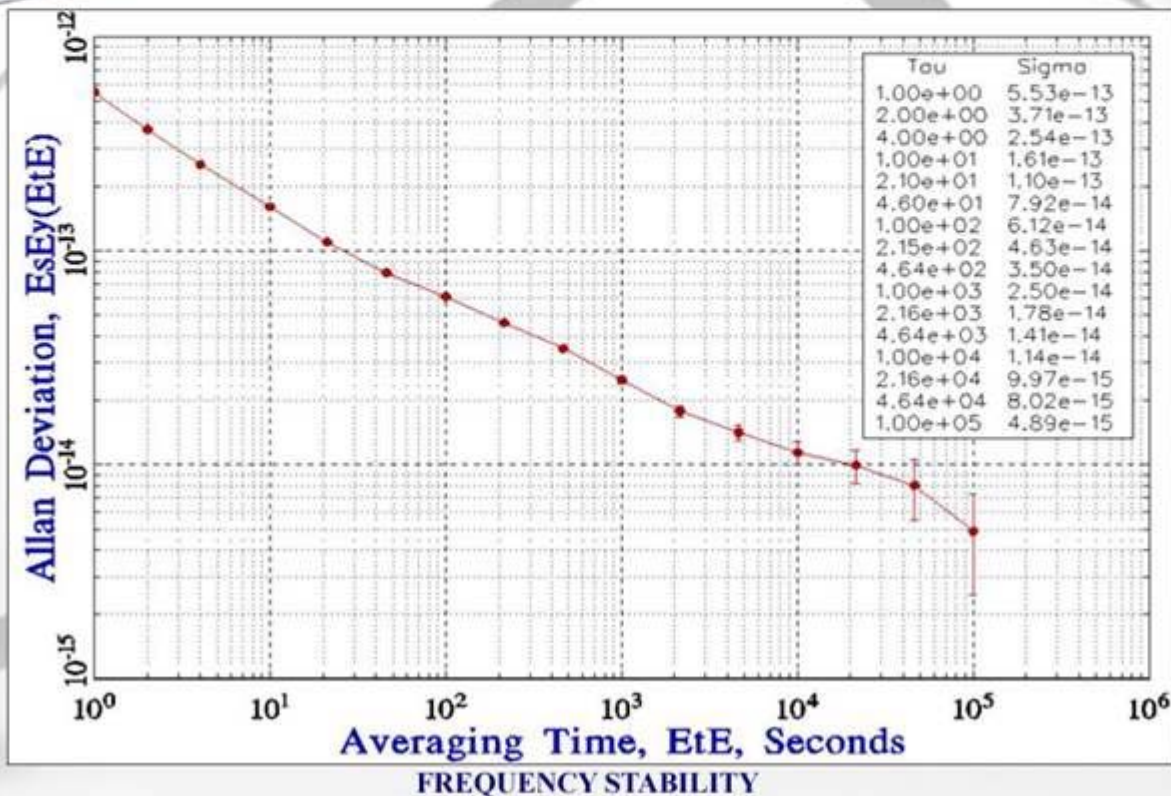



Active Hydrogen Maser

Active Hydrogen Maser Frequency and Time Standard model VCH-1003A

- The best frequency and time stability $2 \times 10^{-13}/1 \text{ s}$ and $2 \times 10^{-15}/1 \text{ day}$
- Frequency drift a few parts $10^{-16}/\text{day}$
- Computer data monitoring and functions control (local or remote)
- Lifetime – 10 years

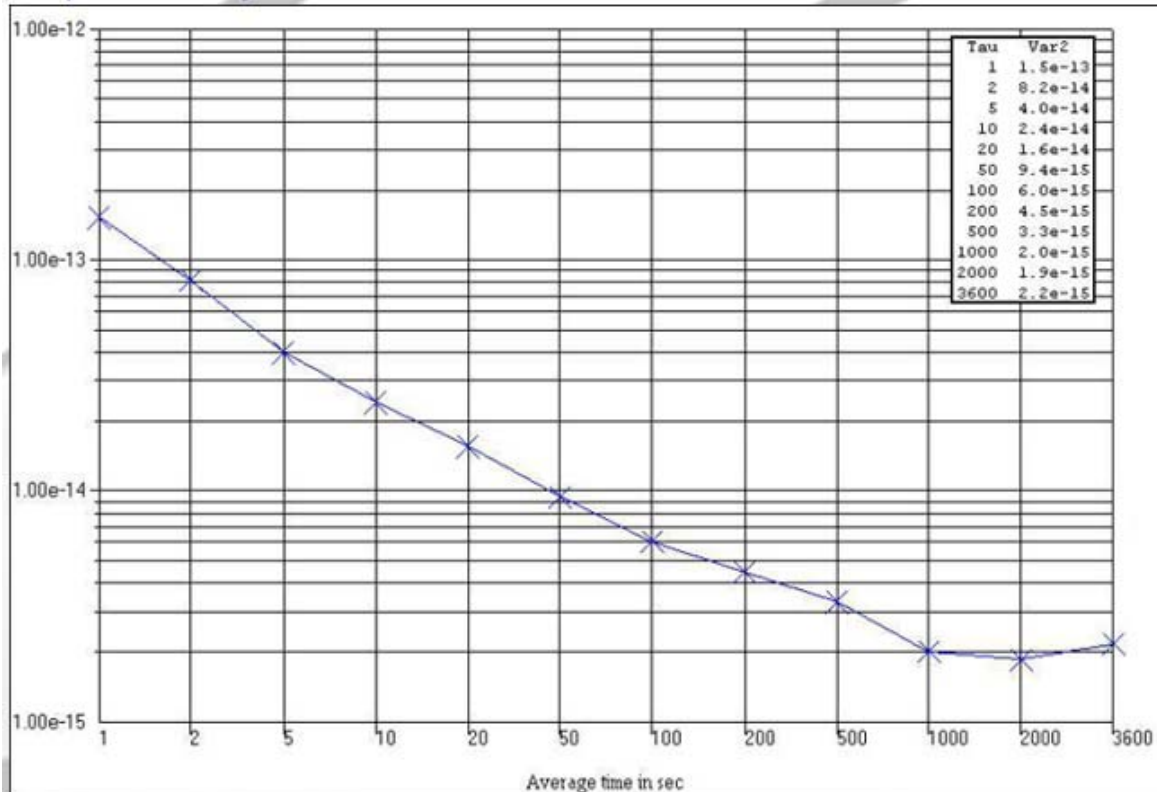

FREQUENCY STABILITY





Summary: Precision Frequency Standards

- Quartz crystal resonator-based ($f \sim 5 \text{ MHz}$, $Q \sim 10^6$)
- Atomic resonator-based

Rubidium cell ($f_0 = 6.8 \text{ GHz}$, $Q \sim 10^7$)

Cesium beam ($f_0 = 9.2 \text{ GHz}$, $Q \sim 10^8$)

Hydrogen maser ($f_0 = 1.4 \text{ GHz}$, $Q \sim 10^9$)

Cesium fountain ($f_0 = 9.2 \text{ GHz}$, $Q \sim 5 \times 10^{11}$)



Section 3

Applications



Commercial Applications

New Quartz Technology

FE-205A

FE-405A

FE-505A

(Poor Man's Rubidium)

STATE OF THE ART QUARTZ CRYSTAL STANDARDS

Models

FE-205A

FE-405A

FE-505A

DESCRIPTION

This new design concept features a precision double oven crystal oscillator capable of analog or digital tuning. The serial digital tuning is ideal for disciplined applications in today's telecommunications industry. The temperature coefficient of this device is less than 1×10^{-6} . This is accomplished with no frequency over or under shoot, with fast temperature slew rates of 4°C per minute. Performance is Determined by a Double Oven SC Cut 5^{th} Overtone Crystal. Output Frequency is Digitally Synthesized.

TYPICAL APPLICATIONS

- Cellular Base Stations
- Test Equipment
- Stratum Clocks
- GPS Timing Systems
- Rubidium Replacement
- Radar Timing
- Military Communications Systems

"PATENTED DESIGN No. 6,577,201"



FREQUENCY ELECTRONICS, INC.

25 Charles Lindbergh Blvd., Mitchel Field, NY 11553
TEL: 516-794-4500 • FAX: 516-794-4340
E-MAIL: sales@freqelec.com
Visit us @: www.freqelec.com



FE-205A



FE-405A & FE-505A

FEATURES

- Analog or Digital Interface [LSB $\approx 1.7 \times 10^{-11}$]
- Excellent Temperature Stability $< 1 \times 10^{-6}$
- -40°C to $+70^{\circ}\text{C}$ Operation
- Low Aging $< 5 \times 10^{-6}$ for 10 yrs.
- Retrace 1×10^{-11} after 1 hour, 24 hrs off
- Any frequency 5 MHz to 25 MHz
- Wide Linear Frequency Tuning Greater Than ± 50 ppm



FE-205A Quartz Oscillator Series

“Poor Man’s Rubidium ???”

- **Readily Available, Producing in Large Quantities**
- **Near Rubidium Accuracy at 1/3 the Cost**
- **Temperature Stability $<1 \times 10^{-10}$ From -40°C to $+75^{\circ} \text{C}$**
- **Low Aging $<3-5 \times 10^{-11}$ / day**
- **Any frequency from 1 pps to 100 MHz
(10 MHz to 15 MHz standard frequencies)**
- **Analog or Digital Frequency Control with better than
1 % Linearity
(both for legacy and new all-digital designs)**
- **Conventional through hole package**
- **Rubidium packages/interchangeability**



2"W x 2"L x 1.5"H



3"W x 3"L x 1.4"H
3"W x 2.8"L x 0.89H



3"W x 3.5"L x 0.98"H



FE-205A Series OCXO

Characteristics

- **SC-cut 5th overtone resonator with good aging and excellent short-term stability.**
- **Thermal control electronics with inner oven stability of $\pm 1 \times 10^{-3} \text{ }^\circ\text{C}$ over a change in ambient temperature of 115°C**
- **Stability of internal reference clock electronic circuit is better than 3×10^{-11} over ambient temperature of -40°C to $+75^\circ\text{C}$ and with a change in Supply Voltage of $\pm 5\%$**
- **High-resolution DDS $\approx 2 \times 10^{-14}$**
- **Microprocessor Controlled**
- **Less than 1×10^{-12} with load variation of $\pm 10\%$**



System Block Diagram

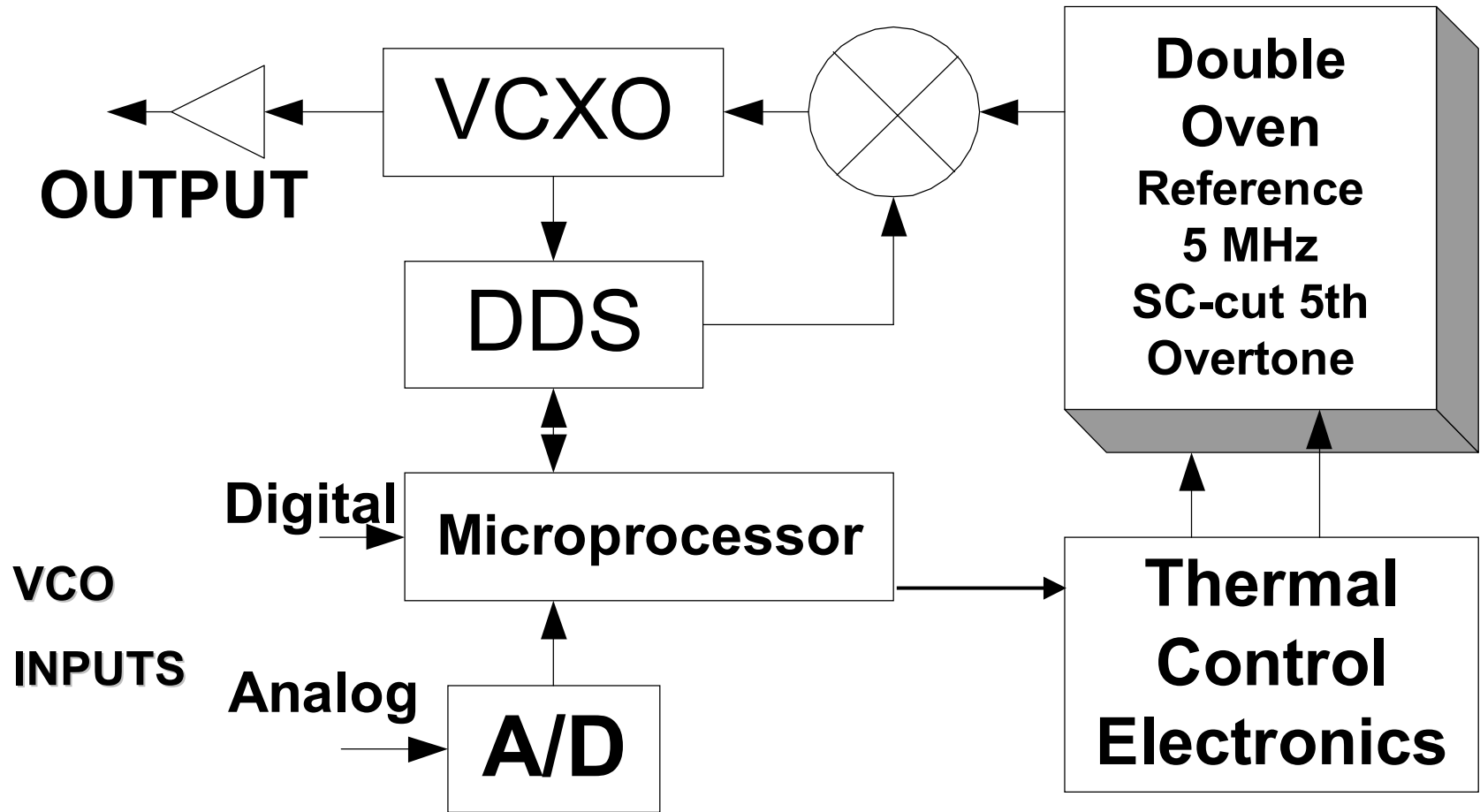

(Patented Design)



Aging: Statistical Data

Aging (Drift)

60% better than 3×10^{-11} /day

90% better than 5×10^{-11} /day

100% better than 1×10^{-10} /day



Double Oven Precision Crystal Oscillator Temperature Performance

Typical
FREQUENCY VS. TEMPERATURE

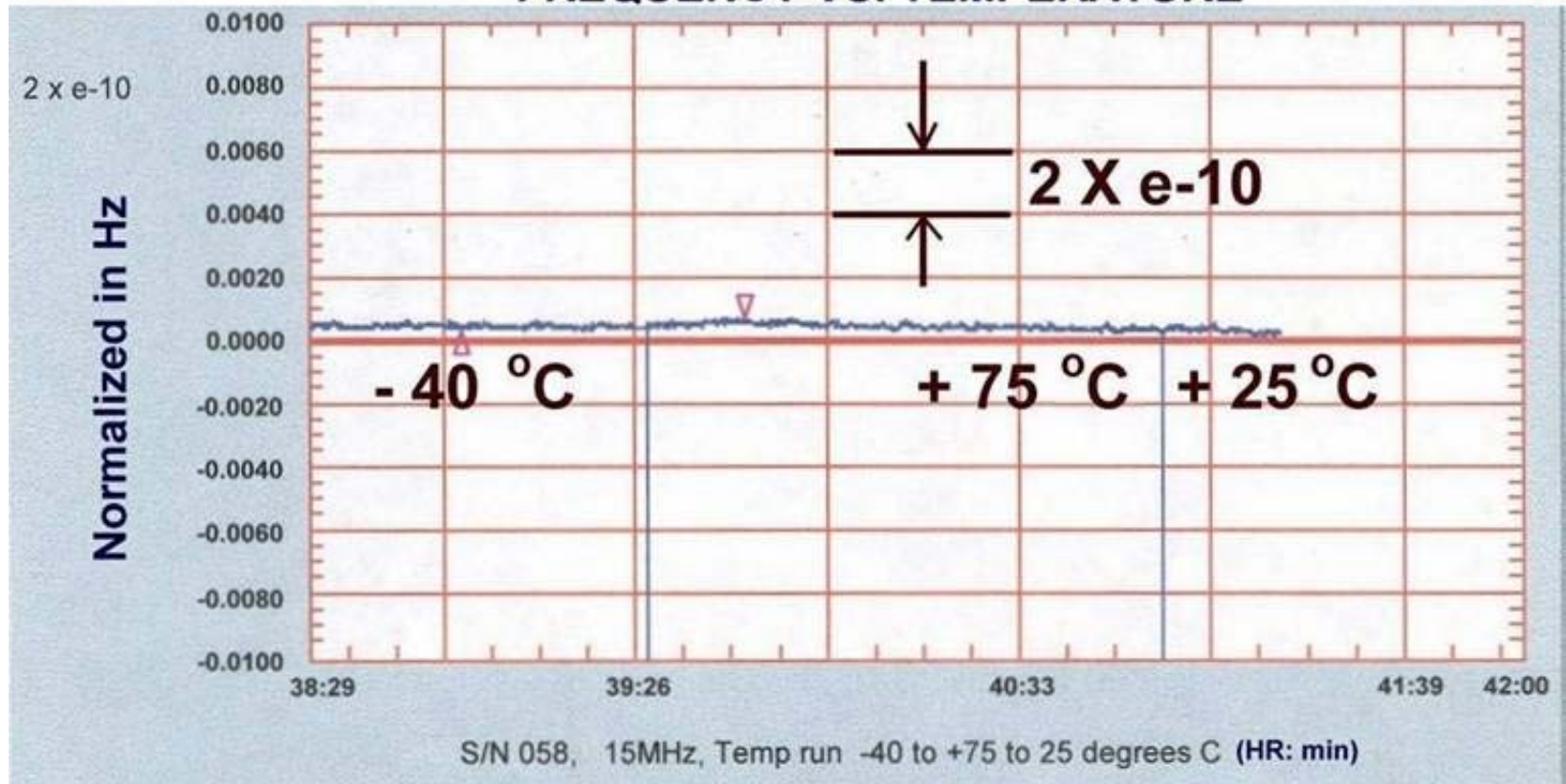



Statistical Data

Frequency Stability vs. Ambient Temperature
(-40°C to +75°C)

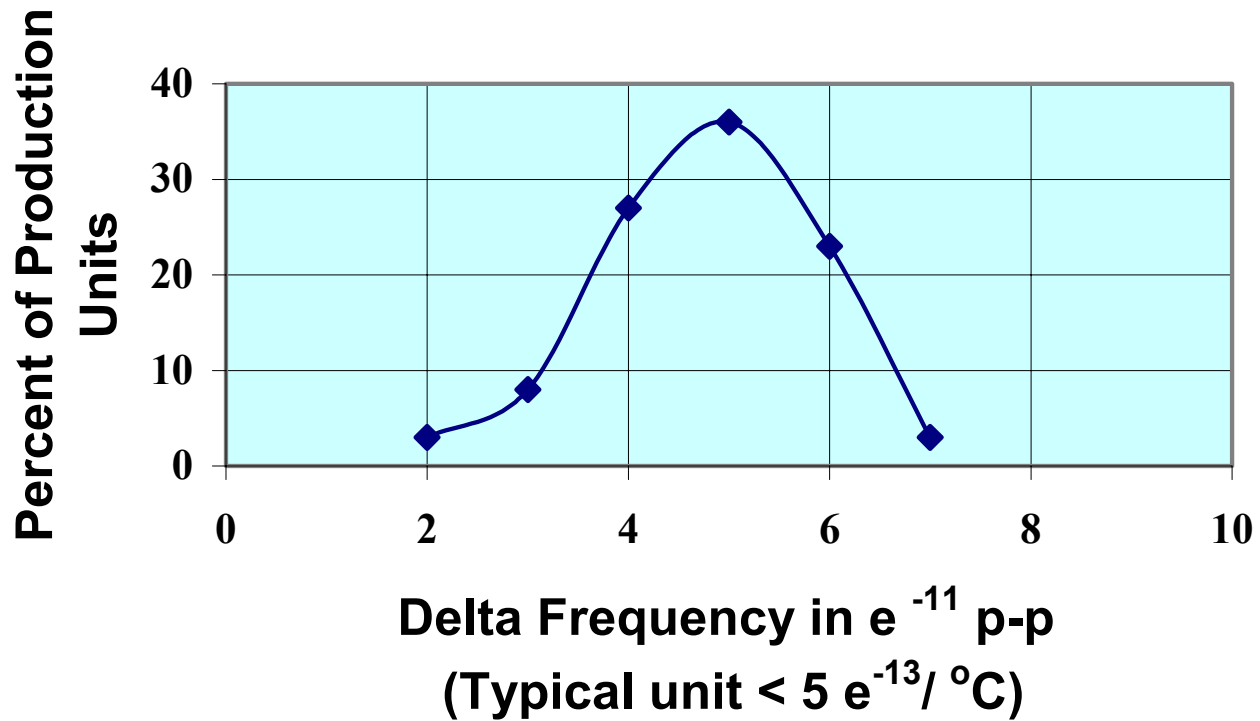



Comparison of Oscillators Stabilities vs. Temperature

Oscillator Type	Frequency Stability (In severe temperature environments e.g. -40°C to $+75^{\circ}\text{C}$, and high slew rates)
Crystal Oscillator (XO)	1×10^{-4} to 1×10^{-5}
Temperature Compensated Crystal Oscillators (TCXO)	1×10^{-6}
Microcomputer Compensated Crystal Oscillators (MCXO)	1×10^{-7} to 2×10^{-8}
Oven Controlled Crystal Oscillators (OCXO)	1×10^{-8} to 3×10^{-10}
Poor Man's Rubidium ??? High-Precision Double Oven Crystal Oscillator (DOCXO)	1×10^{-10}
Rubidium Atomic Frequency Standards (Rb) [-10°C to $+60^{\circ}\text{C}$]	3×10^{-10} to 7×10^{-11}
Cesium Atomic Standard (Cs) [0 $^{\circ}\text{C}$ to $+50^{\circ}\text{C}$]	3×10^{-11} to 3×10^{-12}



Retrace Data

- **Retrace:** After 24 hours of shut off frequency stabilizes within 30 minutes after turn-on to 1×10^{-10} of the previous frequency

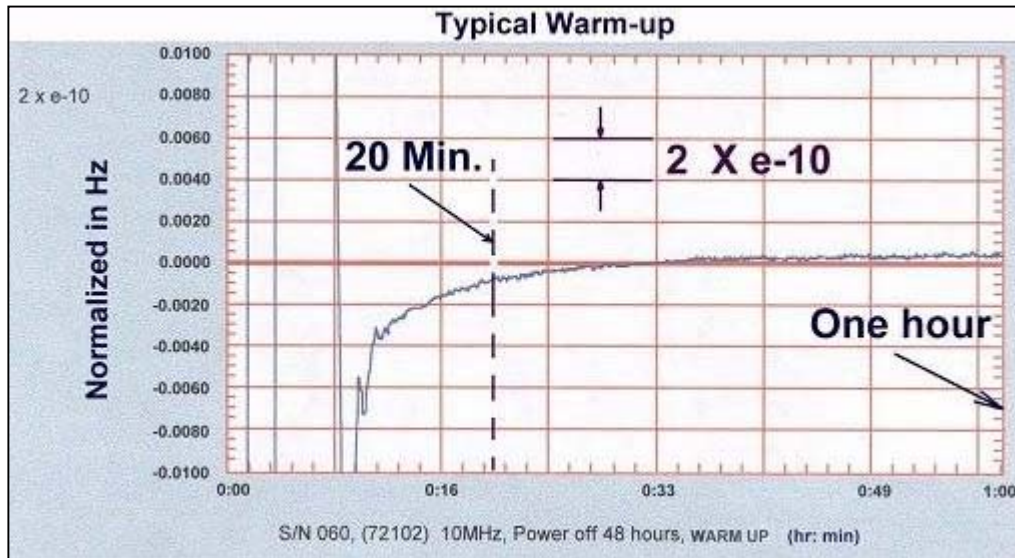
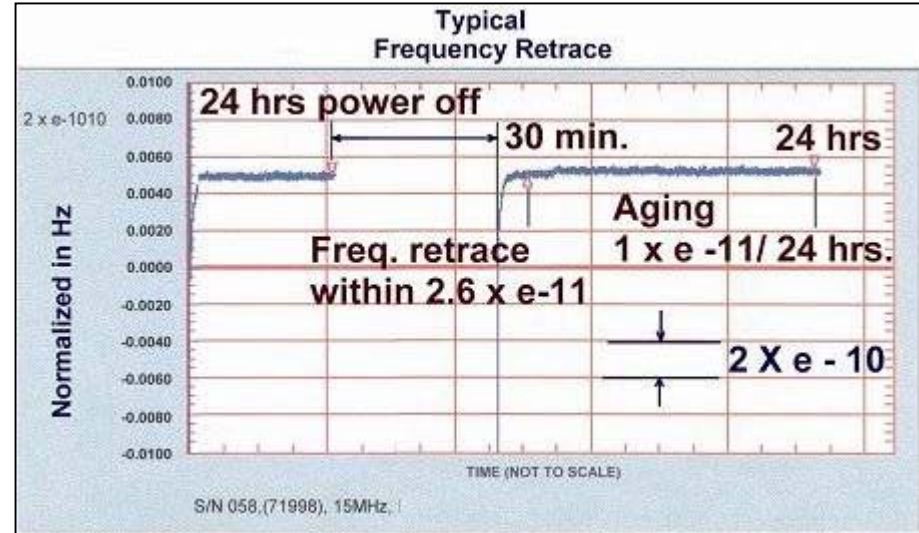

Typical Frequency Retrace of 15 MHz Device

Typical Warm-Up of 10 MHz Device



Phase Noise of 10 MHz Oscillator

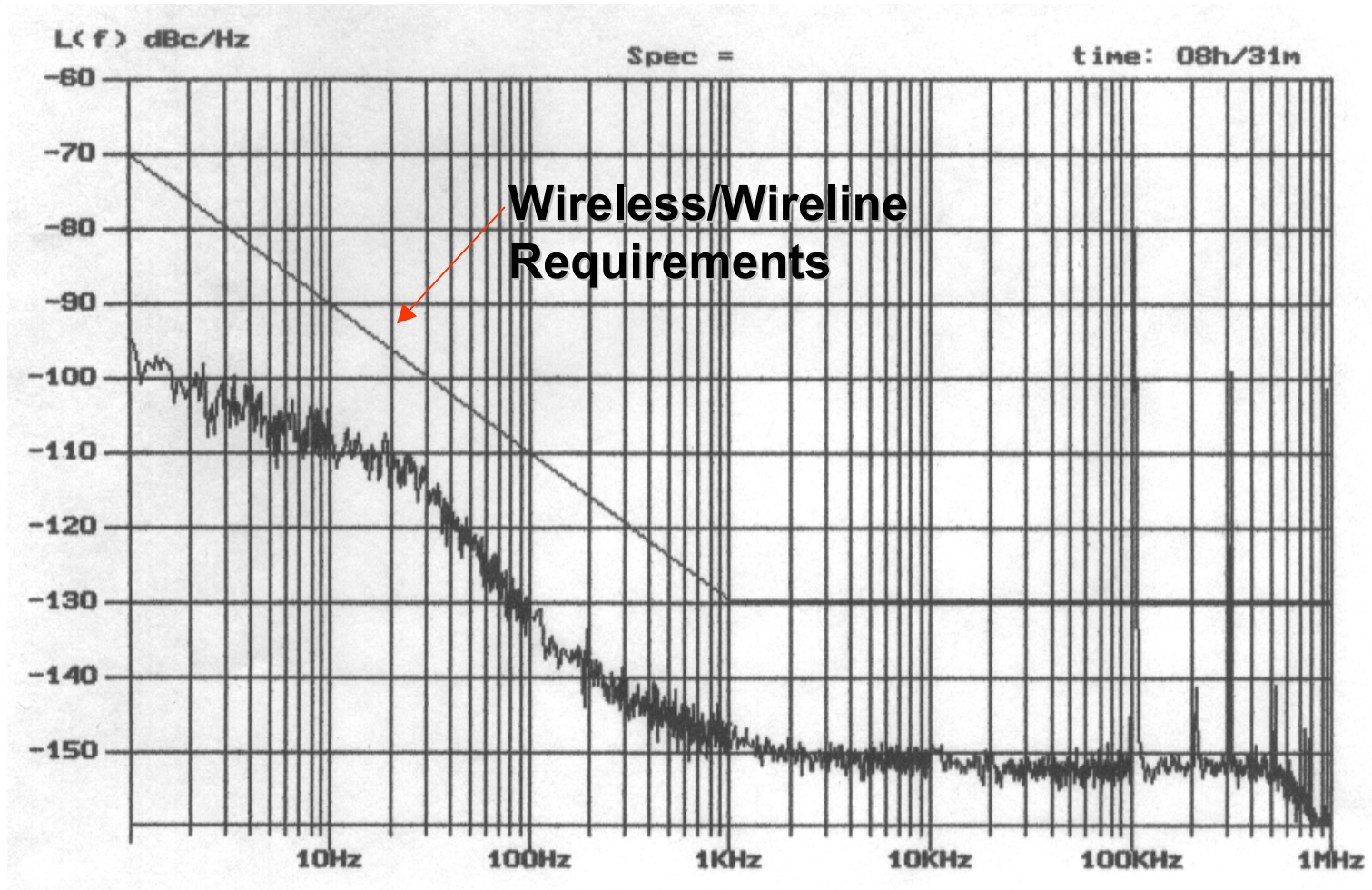



Comparison Chart

<u>Characteristic</u>	<u>Quartz</u>	<u>Rubidium</u>
Power (w)	1 - 2 W	1 - 15 W
MTBF (Hrs)	500K / 1,000K	100K - 200K
Drift/Aging 1 Sec 1 Day 10 Years	1 - 2 x 10 ⁻¹² 3 x 10 ⁻¹¹ 2 - 5 x 10 ⁻⁸	1 - 2 x 10 ⁻¹¹ 1 x 10 ⁻¹¹ { 5 x 10 ⁻¹² } <1 x 10 ⁻⁹
Temperature (-5°C to +50°C)	5 x 10 ⁻¹¹	3.3 x 10 ⁻¹⁰ { 7 x 10 ⁻¹¹ }
Warm up From Cold Storage (off for a long period)	1 x 10 ⁻¹⁰ in 48-96 Hrs	1 x 10 ⁻¹⁰ in 1 Hr



Comparison (Continued)

<u>Characteristic</u>	<u>Quartz</u>	<u>Rubidium</u>
Warm up Short Power Interrupt 1 to 2 Hrs off 1 Day off	1×10^{-10} in 1 Hr 1×10^{-10} in 1 to 24 Hrs	1×10^{-11} in 1 Hr 1×10^{-11} in 24 Hr
Phase Noise	Meets Specs	Meets Specs
Spurious	-80 dBc	-70 dBc
Cost	1X	3X
Life	No known wear out mechanism	Rb consumption in 10 to 15 years



Synchronization for Wireless Base Stations ***CDMA, UMTS, W-CDMA, TDMA*** ***Plug in Assemblies***

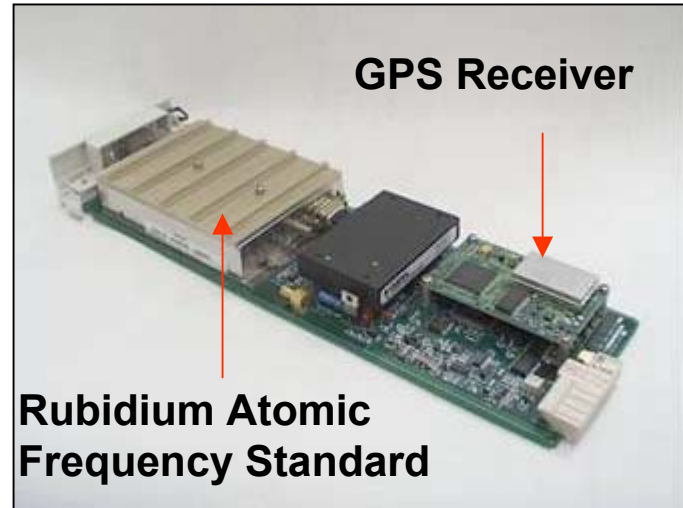
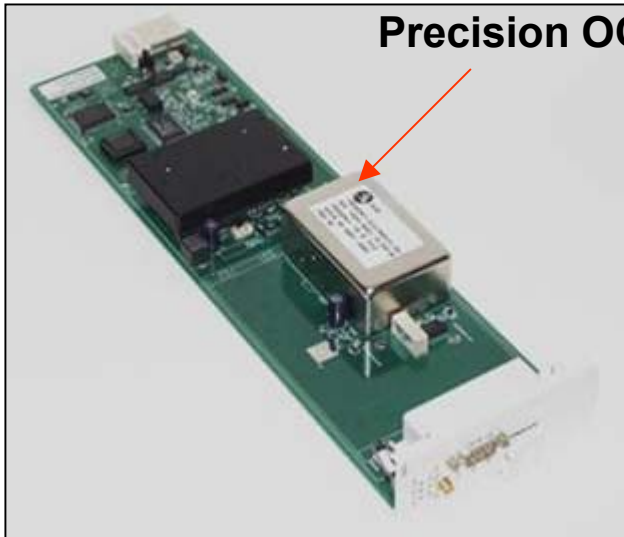

- GPS disciplined Rubidium/Quartz
- Customized packaging
- Optimized for extreme temperature swings
- Excellent aging and temperature stability
- Hot swappable with glitch free operation

Rubidium Frequency Atomic Standard module directly interchangeable with OCXO module

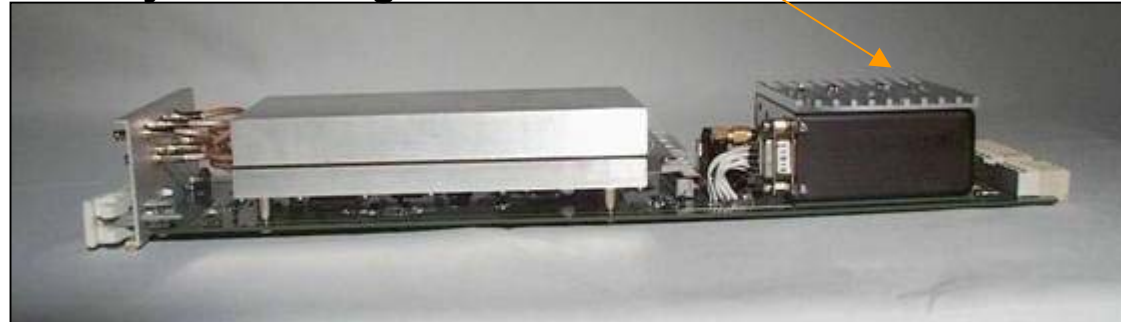



Wireless





SPACE APPLICATIONS



Quartz for Space applications

FE-4220A

OCXO

SPACE QUALIFIED

OVEN CONTROLLED CRYSTAL OSCILLATOR

Description

The FE-4220A Series of Space Qualified Low Noise Quartz Oscillators features operation from 20Mhz to 145Mhz with Low Phase Noise and excellent stability. A unique Class "K" Hybrid Assembly (MIL-PRF-38534) in conjunction with a 5th overtone SC-Cut Crystal achieves Low Aging, Temperature Stability and excellent Radiation Immunity (100Krads) needed in the Space Environment. An External DC Voltage Input or Resistor is provided for Fine Frequency Adjustment.

Features

- Low Phase Noise
- Excellent Temperature Stability $< \pm 2 \times 10^{-7}$
- -10°C to $+60^{\circ}\text{C}$ Operating
- Low Aging ± 1 ppm for life
- Space Qualified
- Radiation Immunity 100 Krads
- Highly Reliable: Over 20 years of space service with zero failures
- Small Size and Light Weight

Typical Applications

- Clocks for Spacecraft

Model
FE-4220A



Specifications on reverse side



MASTER LOCAL OSCILLATOR MODEL FE-2139A

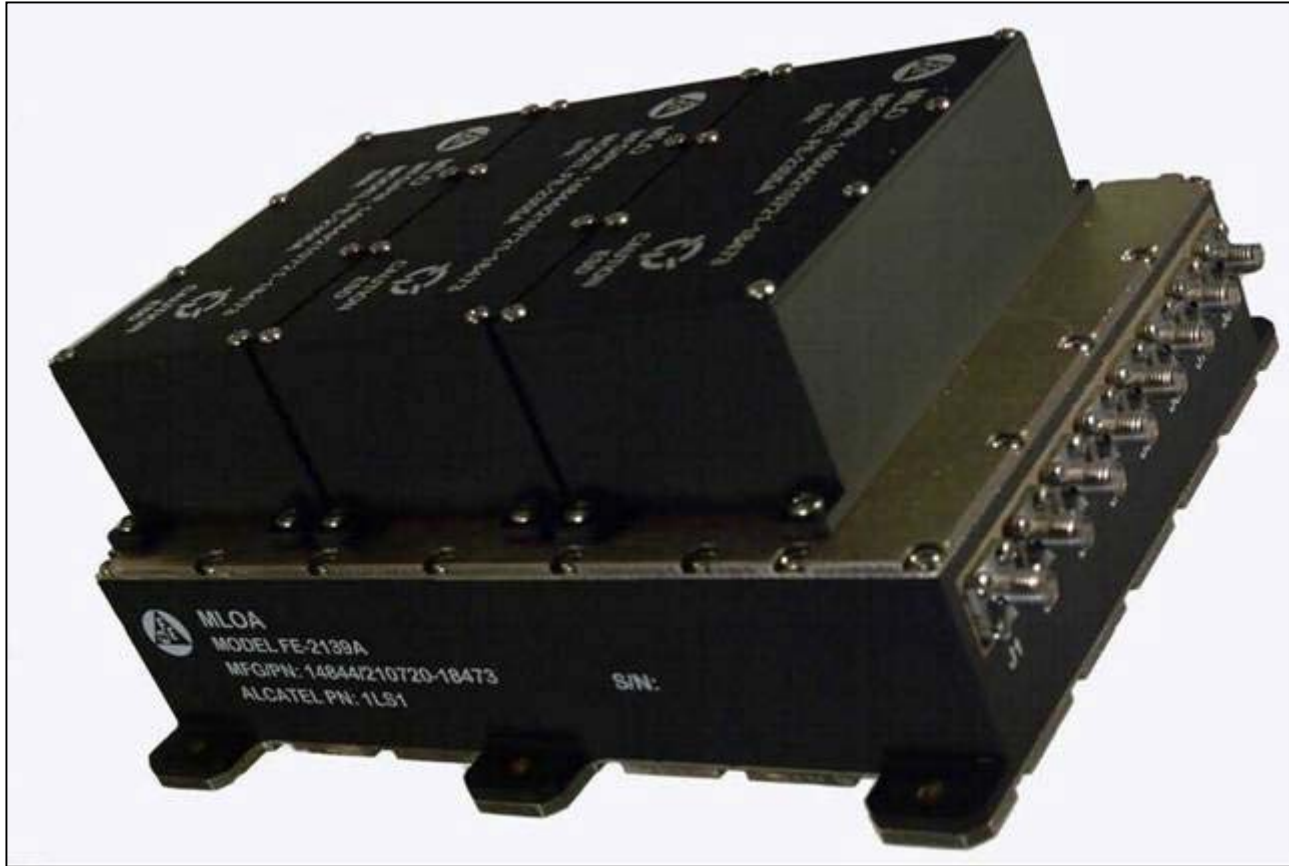



PRECISION FREQUENCY REFERENCE SOURCES

**Triple Redundant Master Local Oscillator
(MLO) and Distribution Assembly**

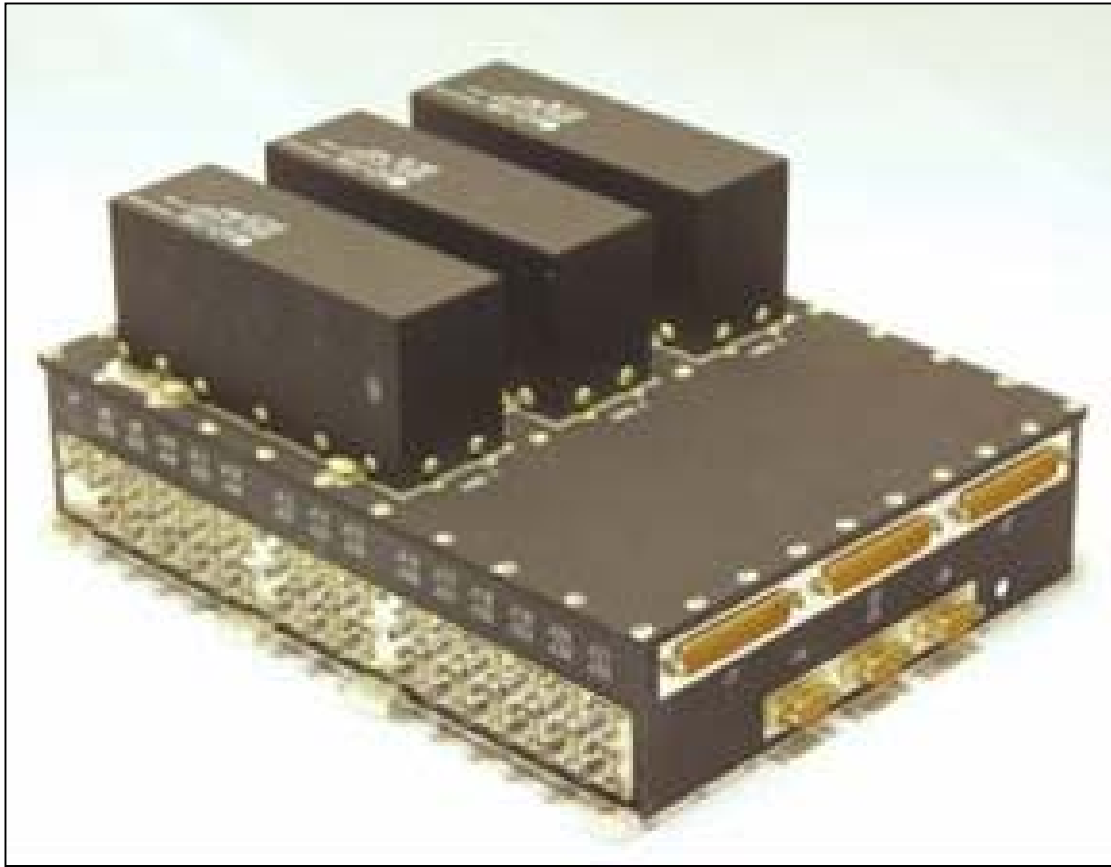



FREQUENCY SOURCES / GENERATORS

ACTS

Frequency Generator FE-5150A

5 MHz to 6.8 GHz; Fully Redundant; Includes DC / DC Converter

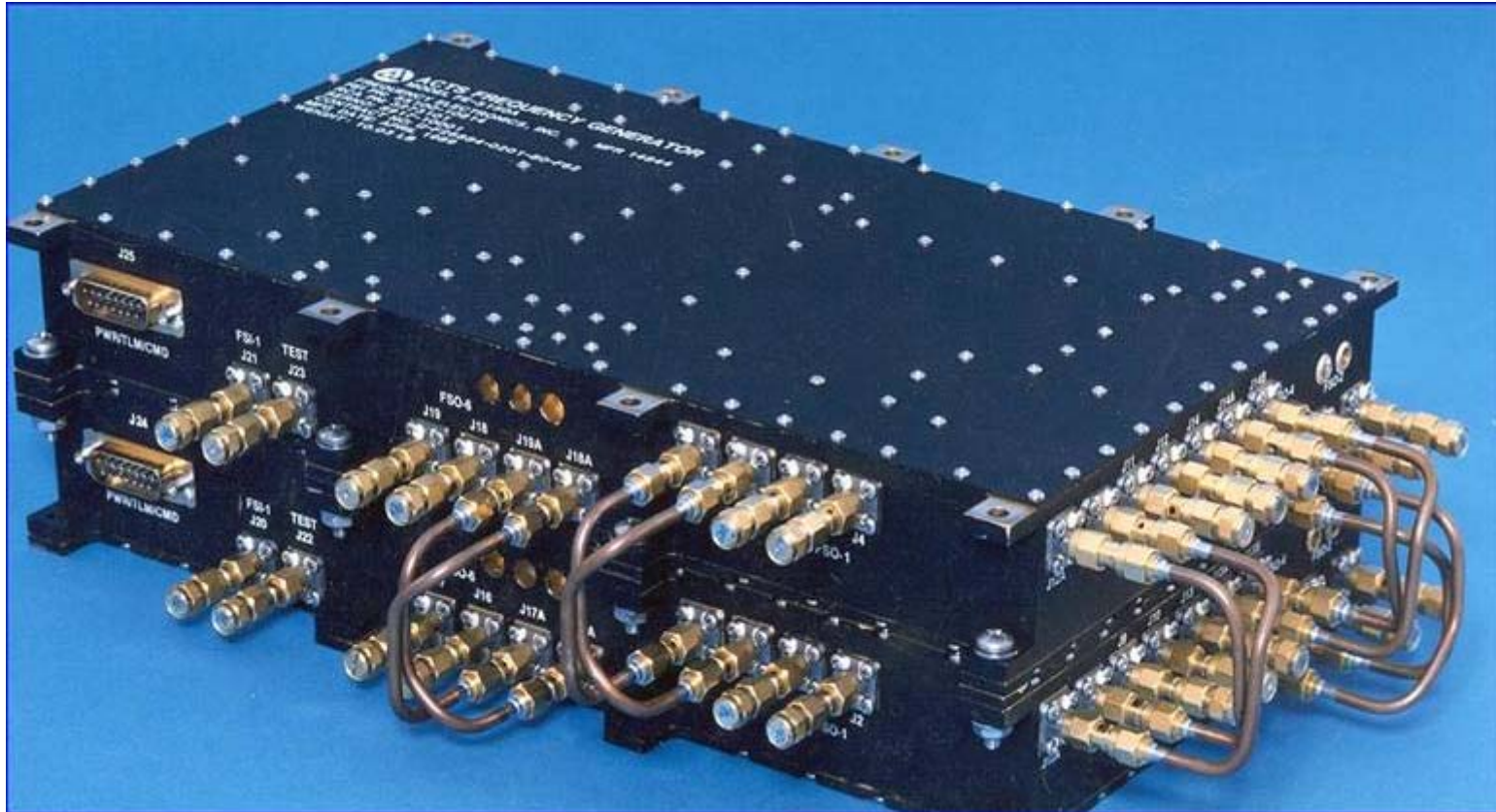



Double Oven Crystal Oscillator with Dewar Flask

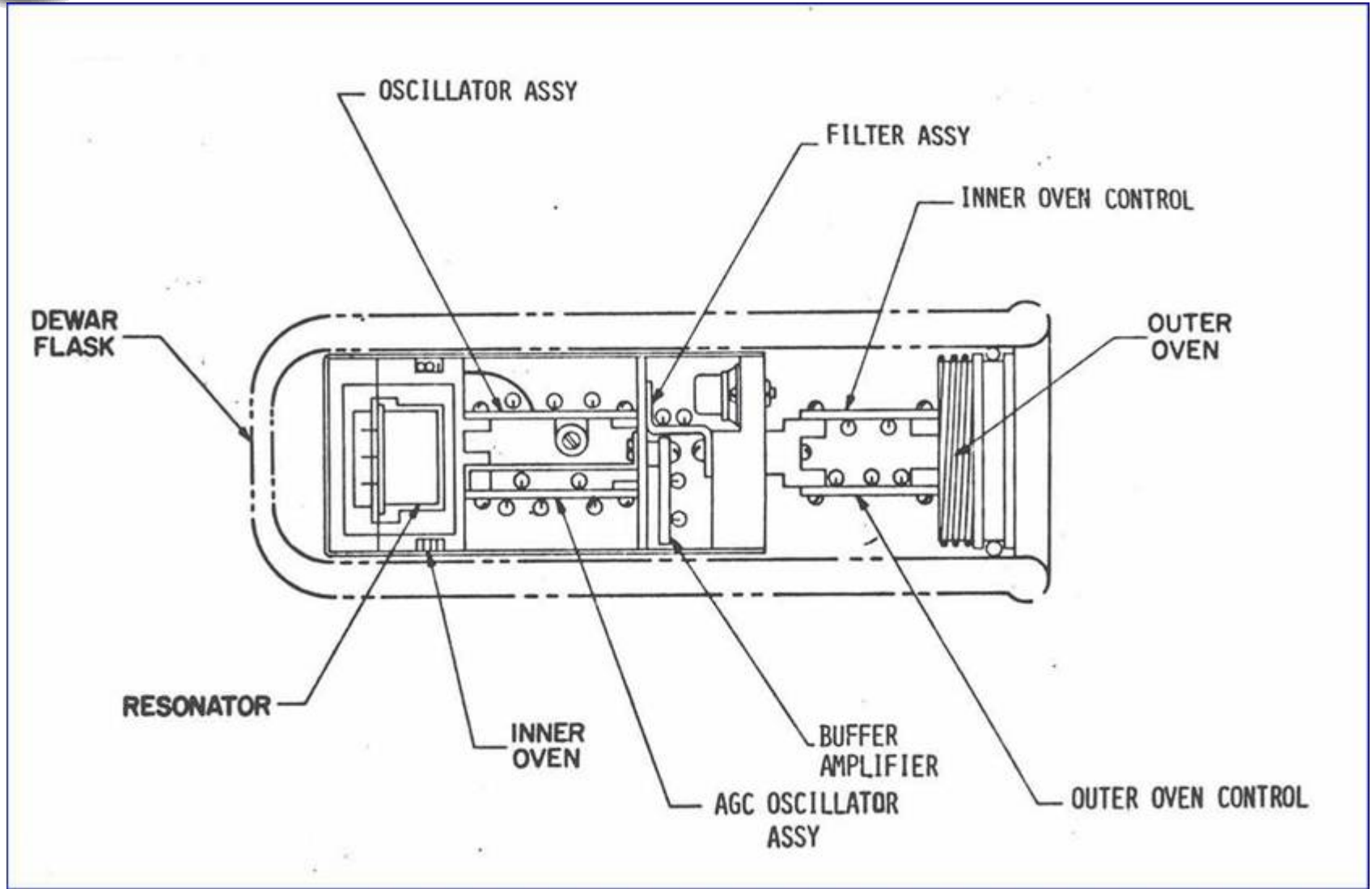



MLO Assembly

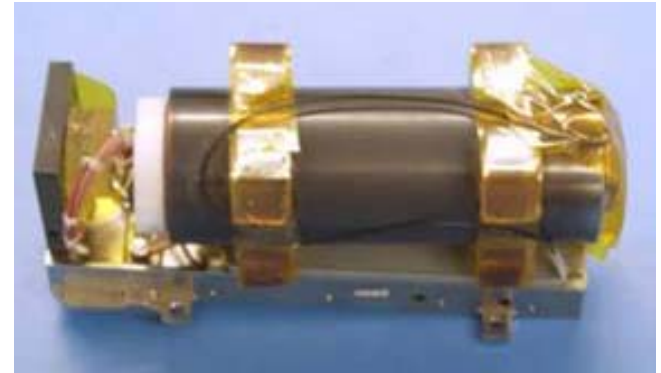

Master Oscillator Assembly



DC to DC Converter



MILSTAR TIMEKEEPING With FEI Supplied Clocks

Milstar Today

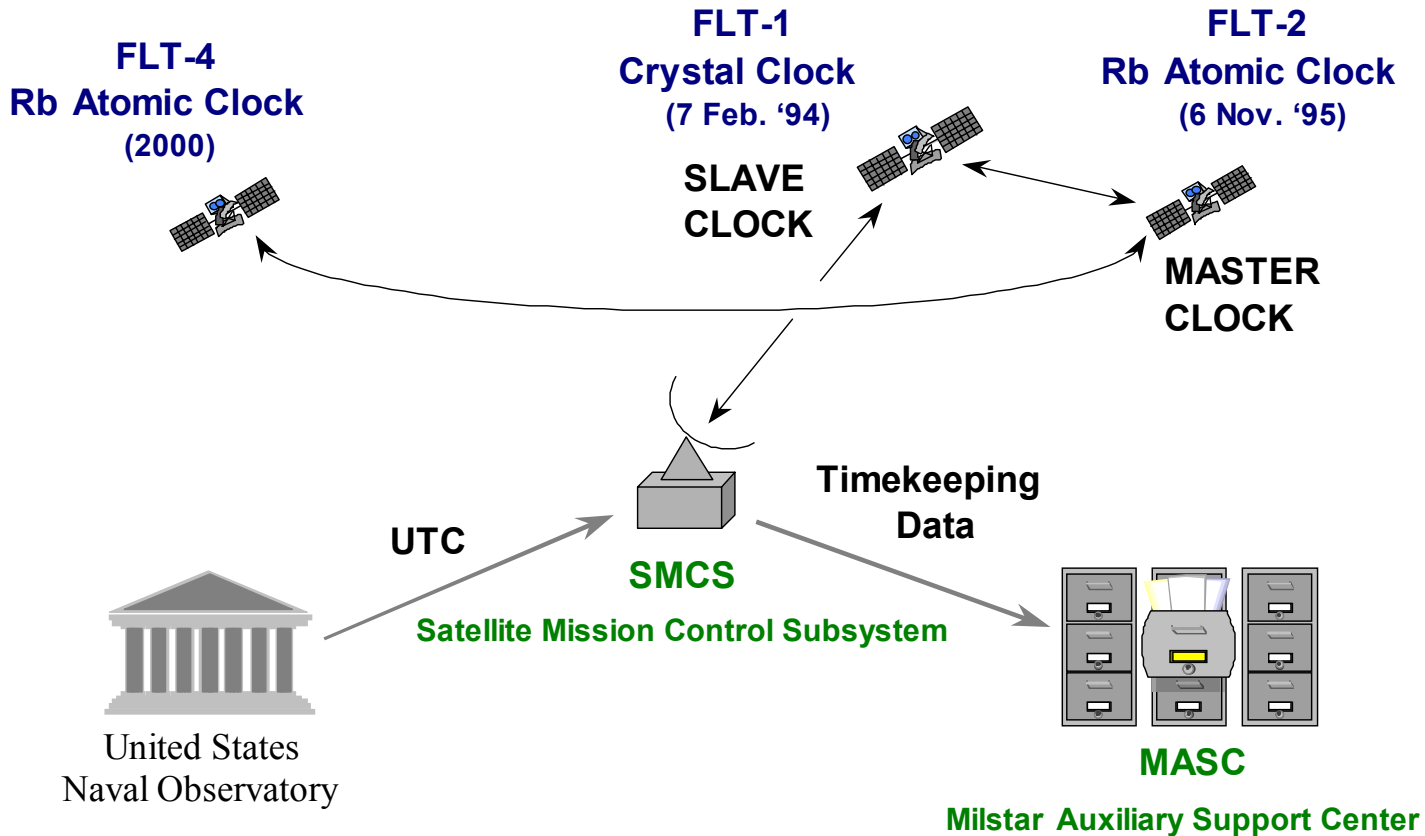



RUBIDIUM PRECISION FREQUENCY REFERENCE SOURCES

MILSTAR

Rubidium Master Oscillator SN 003

Total of 19 systems delivered to MILSTAR

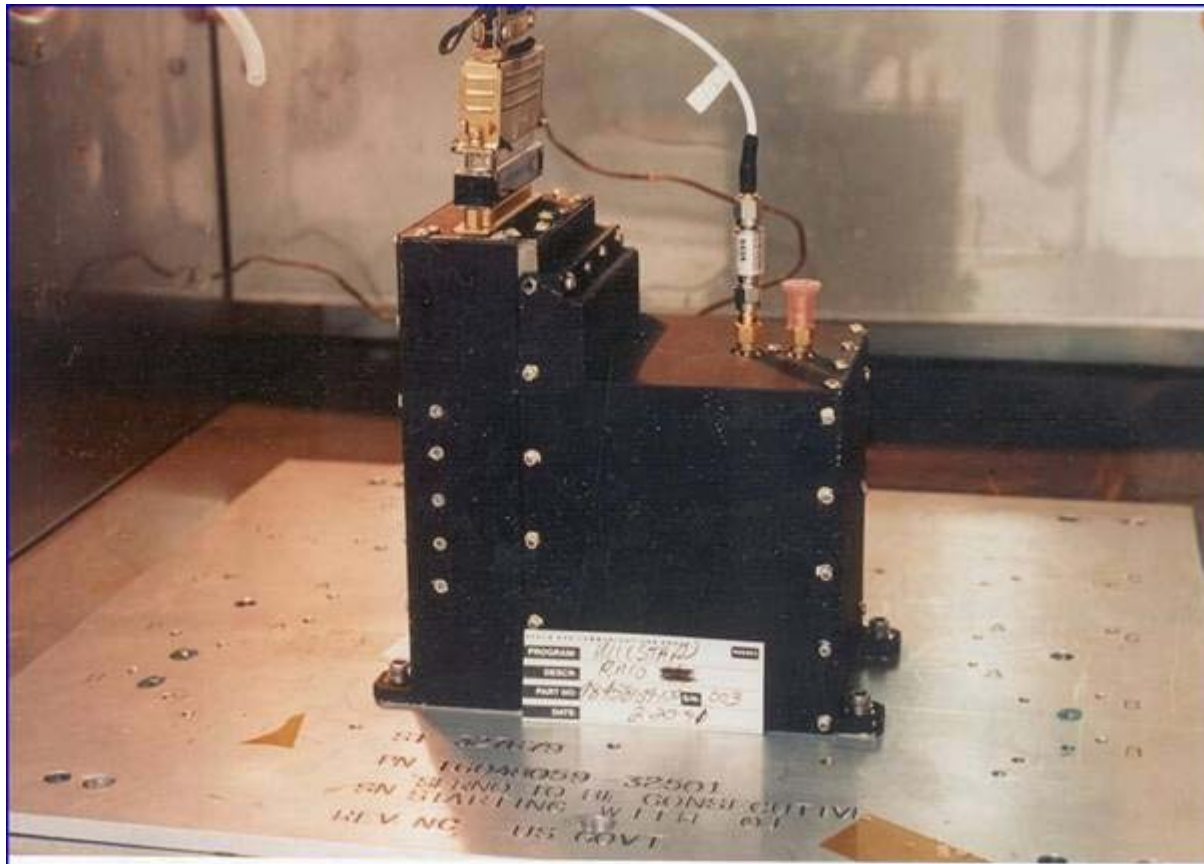

**Excellent
performance
in space**

**Aging Rate:
 $\approx 7 \times 10^{-14}/\text{day}$**



Rubidium in Space Clocks

MILSTAR

- **Rubidium Master Oscillator (RMO) on board MILSTAR Space Craft since 1995**
 - FLT 2 4 Redundant Rb Clocks
 - FLT 3 4 Redundant Rb Clocks
 - FLT 4 4 Redundant Rb Clocks
- **Two Satellites soon to be launched**
 - FLT 5 3 Redundant Rb Clocks
 - FLT 6 3 Redundant Rb Clocks

Because of the extensive reliability experienced in FLT 2 to 4 the configuration in FLT 5 and FLT 6 were reduced to Three Redundant Rb Clocks



Rubidium in Space Clocks

MILSTAR

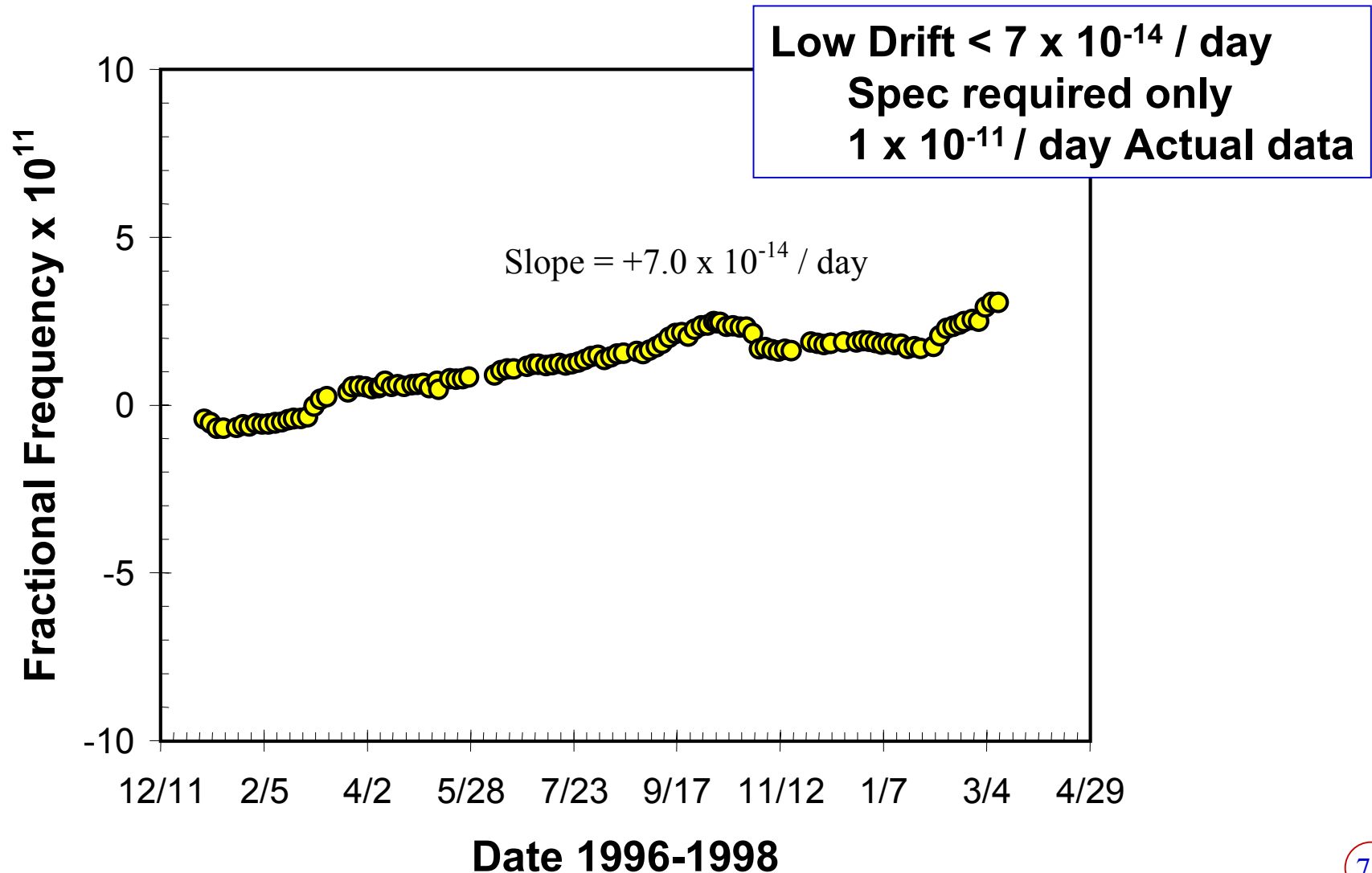



GPS APPLICATIONS

- **Commercial**
- **Military i.e. SAASM**



Oscillator's Impact on GPS

- Satellite oscillator's (clock's) inaccuracy & noise are major sources of navigational inaccuracy.
- Receiver oscillator affects GPS performance, as follows:

<u>Oscillator Parameter</u>	<u>GPS Performance Parameter</u>
Warmup time	Time to first fix
Power	Mission duration, logistics costs (batteries)
Size and weight	Manpack size and weight
Short term stability (0.1 s to 100 s)	Δ range measurement accuracy, acceleration performance, jamming resistance
Short term stability (~15 minute)	Time to subsequent fix
Phase noise	Jamming margin, data demodulation, tracking
Acceleration sensitivity	See short term stability and phase noise effects



Building Blocks of a Time/Frequency System

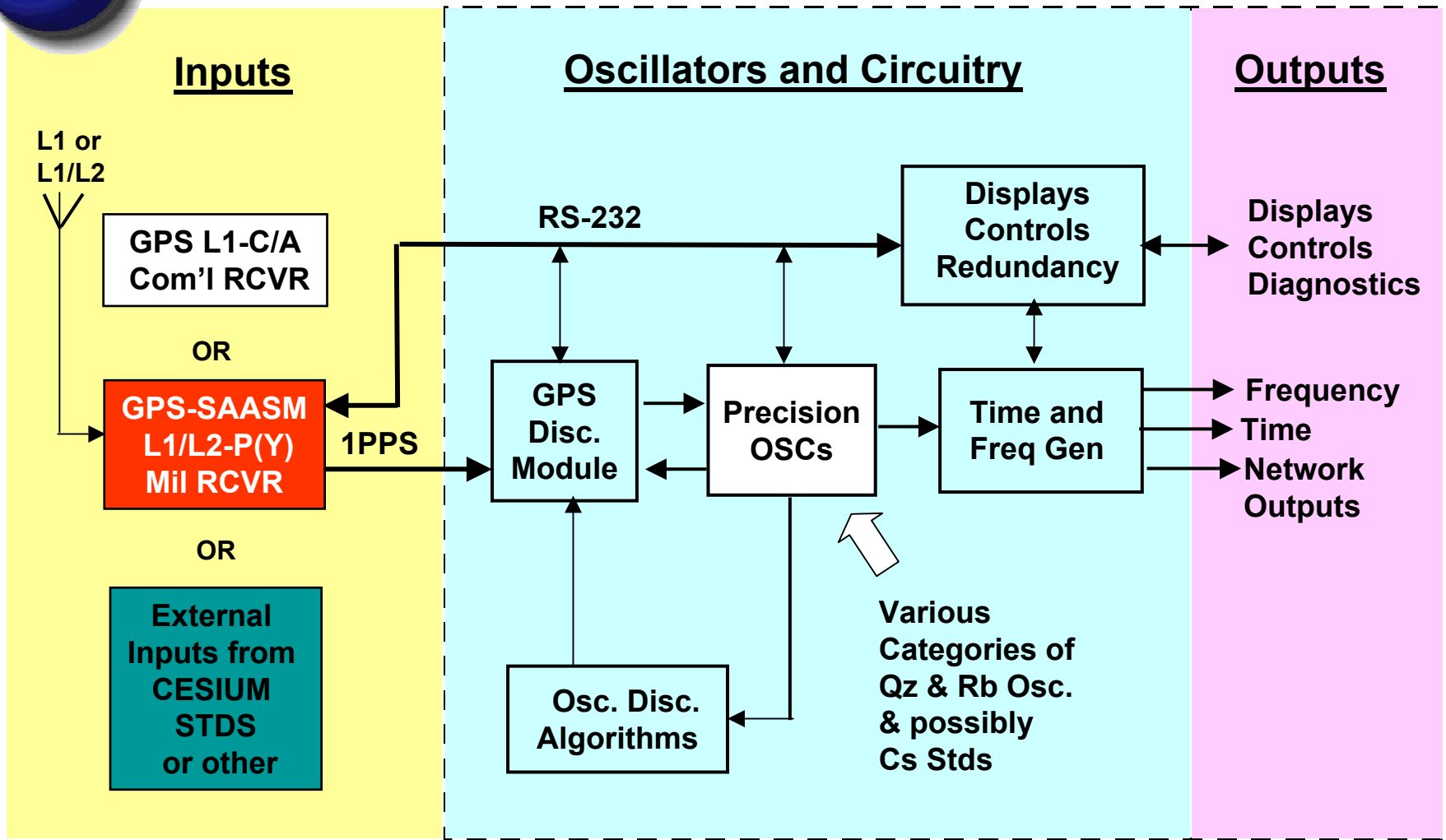



Examples of GPS Based Products

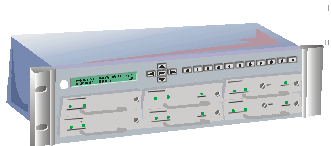

**Kstar II and
CommSync**



**C-GPS and
R-GPS**

**Cell-Site Time/Frequency Generation
and Synchronization**



**AccuSync and AccuSync-R
GPStarplus**

**Low Profile, General Purpose Time and
Frequency Synchronization**



**CommSync II – Civil C/A- Code,
Military P(Y)-Code SAASM, and
Distribution Amps (DA)**

**Commercial and Military
Ground and Satellite Link,
High Functionality Time &
Frequency Sync Systems**



**GSync – Civil C/A and
Military P(Y)-Code SAASM**



Portable Clock



**NanoSync
E911 Engines**

**Sub-Systems and Modules for E911
and Special Purpose Applications**



NTPSync



NTPSync XL

LAN, WAN, MAN GPS-aided Timing



Redundant SAASM CommSync II Modular Time & Frequency System (3U)



Imbedded Trimble
Force-22 SAASM
Receiver

OR

Commercial
C/A-Code
GPS RCVRs



Atomic Oscillators
OR
Qz Oscillators

CommSync II
GTF Module



Plug-In
Output
Modules





Radar Applications



Effect of Noise in Doppler Radar System

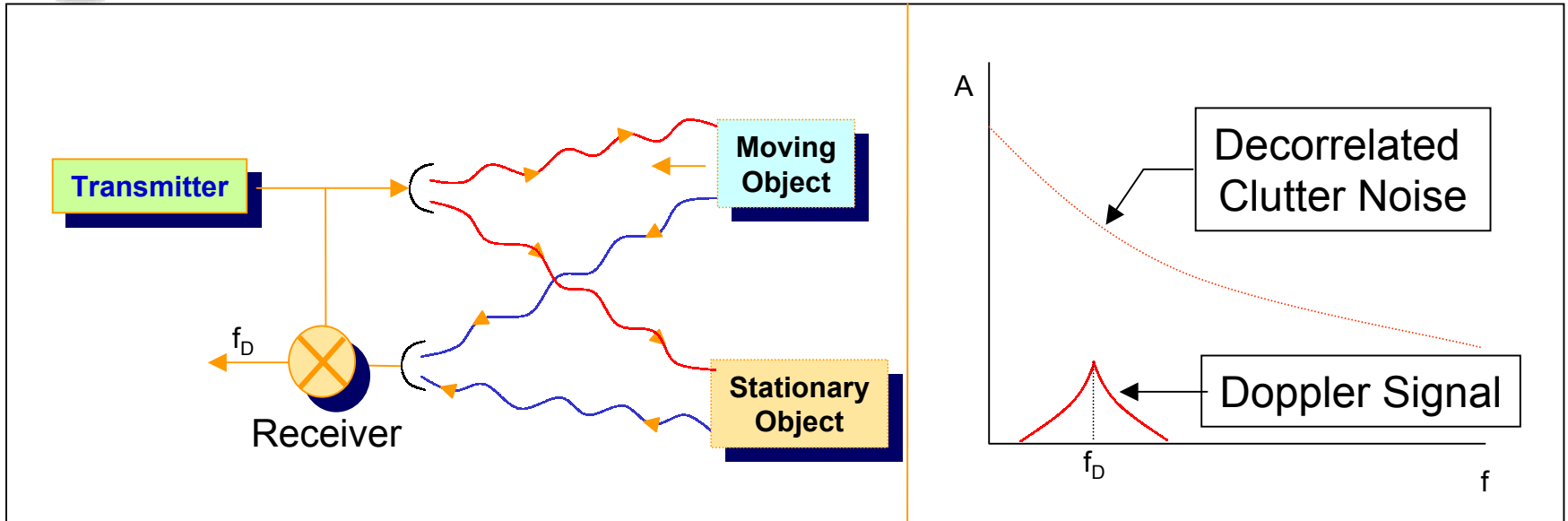

- Echo = Doppler-shifted echo from moving target + large "clutter" signal
- (Echo signal) - (reference signal) --> Doppler shifted signal from target
- Phase noise of the local oscillator modulates (decorrelates) the clutter signal, generates higher frequency clutter components, and thereby degrades the radar's ability to separate the target signal from the clutter signal.



Doppler Shifts

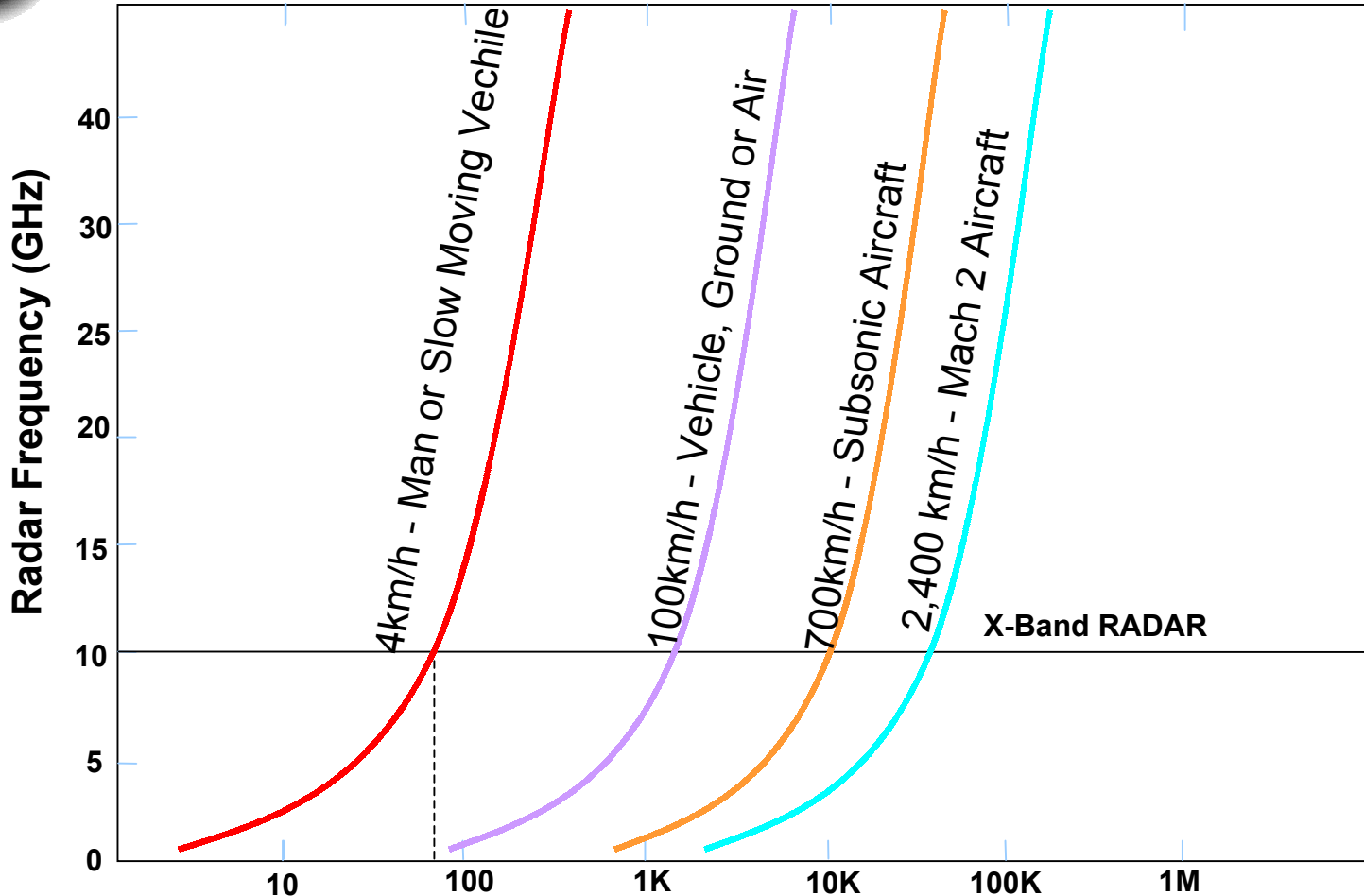

Doppler Shift for Target Moving Toward Fixed Radar (Hz)

- Doppler radar require low-phase-noise oscillators. For example to detect slow-moving targets the noise close to the carrier must be low



Section 4

***Breakthrough in Vibration
Effects on Clocks Stabilities
and Side Bands***

**Vibration Insensitive
Oscillators???**



***Single Side Band Phase
Noise Resulting From
Vibrations Will Significantly
Affect Oscillator
Performance***



Acceleration vs. Frequency Change

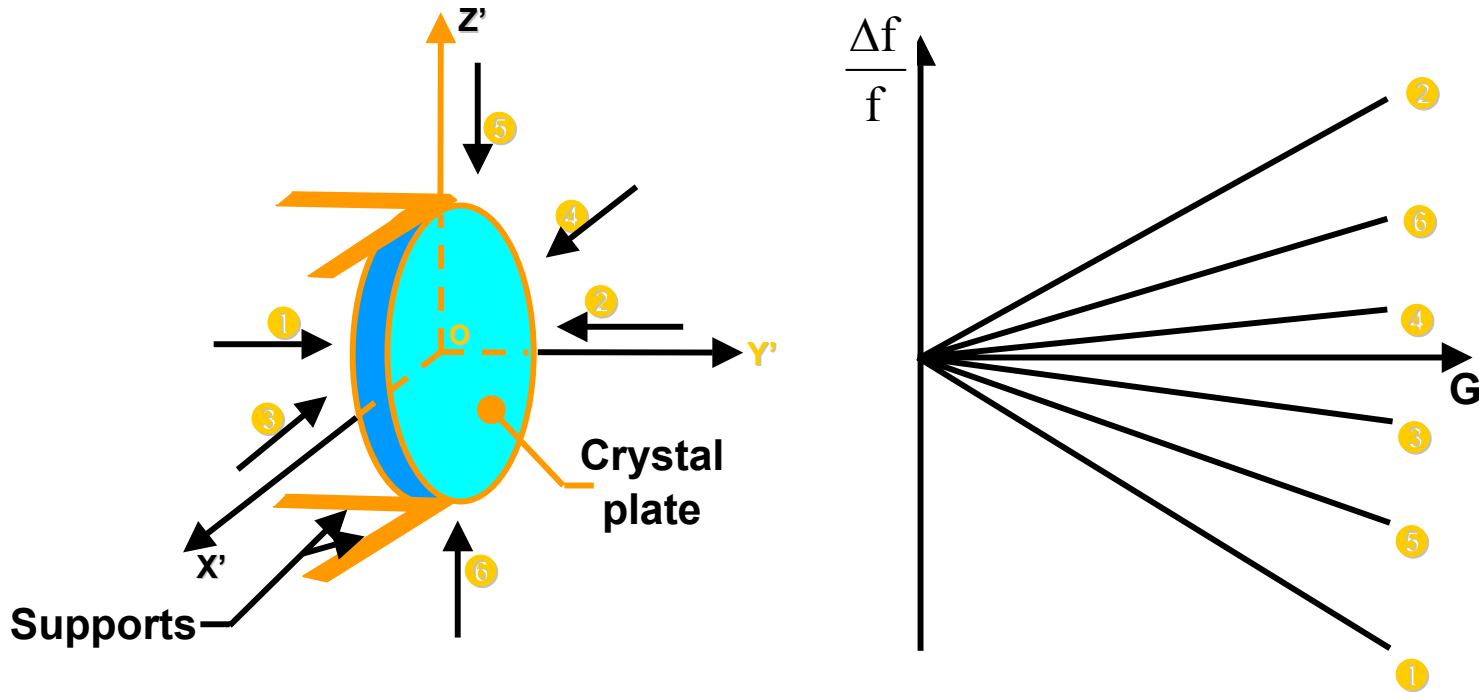

Frequency shift is a function of the magnitude and direction of the acceleration, and is usually linear with magnitude up to at least 50 g's.



Acceleration Levels and Effects

Environment	Acceleration typical levels*, in g's	$\Delta f/f$ x10⁻¹¹, for 1x10⁻⁹/g oscillator
Buildings**, quiescent	0.02 rms	2
Tractor-trailer (3-80 Hz)	0.2 peak	20
Armored personnel carrier	0.5 to 3 rms	50 to 300
Ship - calm seas	0.02 to 0.1 peak	2 to 10
Ship - rough seas	0.8 peak	80
Propeller aircraft	0.3 to 5 rms	30 to 500
Helicopter	0.1 to 7 rms	10 to 700
Jet aircraft	0.02 to 2 rms	2 to 200
Missile - boost phase	15 peak	1,500
Railroads	0.1 to 1 peak	10 to 100

* Levels at the oscillator depend on how and where the oscillator is mounted
Platform resonances can greatly amplify the acceleration levels.

** Building vibrations can have significant effects on noise measurements



Crystal G-Sensitivity (Gamma)

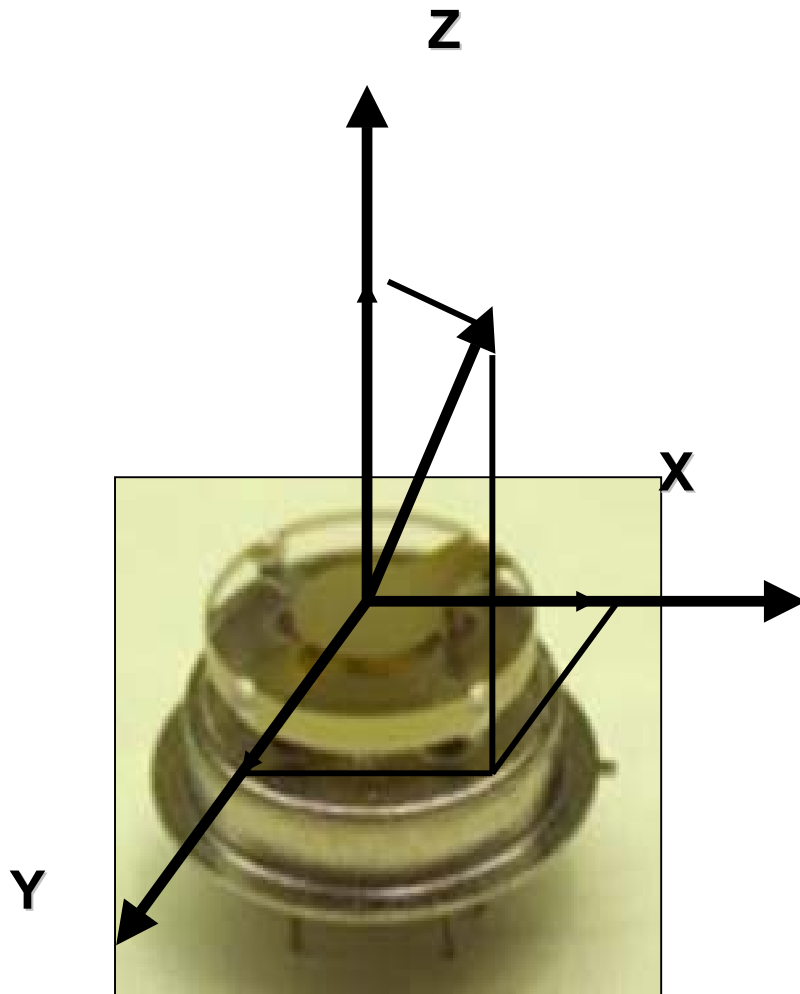

Γ is G sensitivity in Hz/G

$$\Gamma = (X^2 + Y^2 + Z^2)^{1/2}$$

$$\Gamma = (3^2 + 3^2 + 3^2)^{1/2} = 5.2 \times 10^{-10}$$

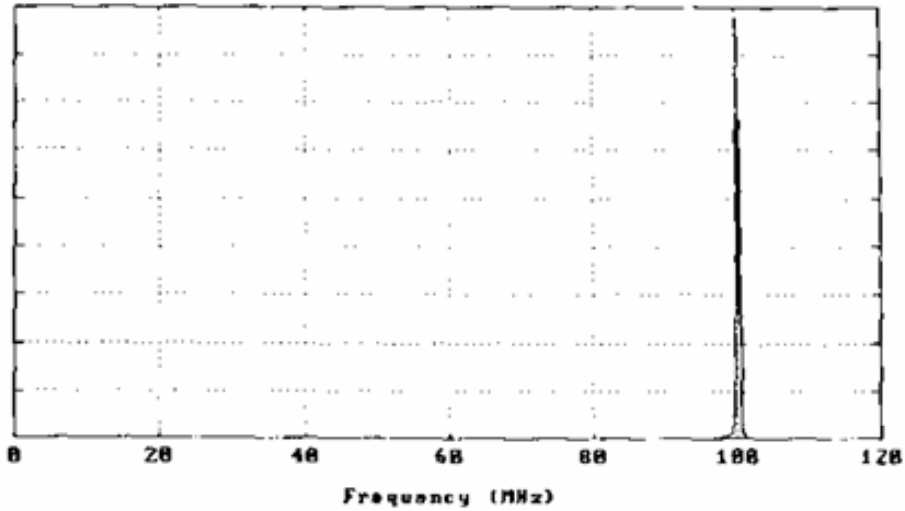

Ideal Sine Wave (Frequency)

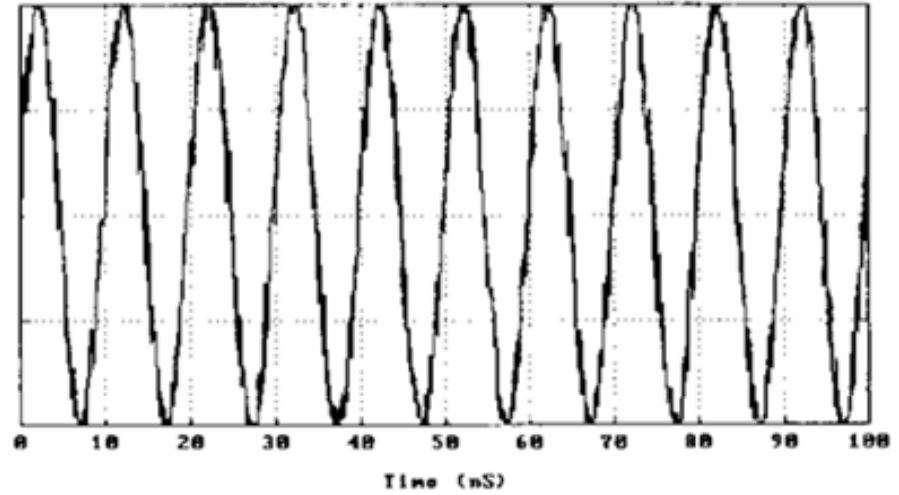

100 MHz w/Phase Noise (Time)

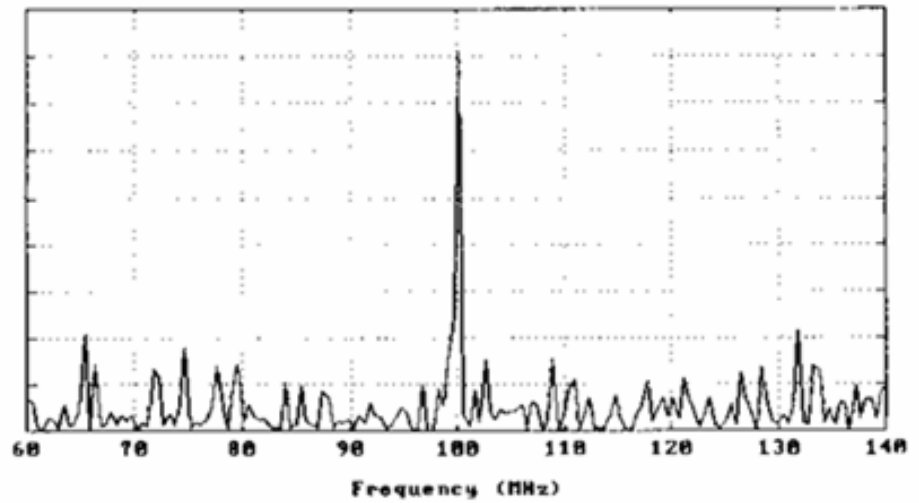

100 MHz w/Phase Noise (Frequency)



Vibration-Induced Sidebands

NOTE: the “sidebands” are spectral lines at $\pm f_v$ from the carrier frequency (where $f_v =$ vibration frequency). The lines are broadened because of the finite bandwidth of the spectrum analyzer.

These Unwanted Sidebands are Significantly Attenuated with FEI's Proprietary Compensation Techniques

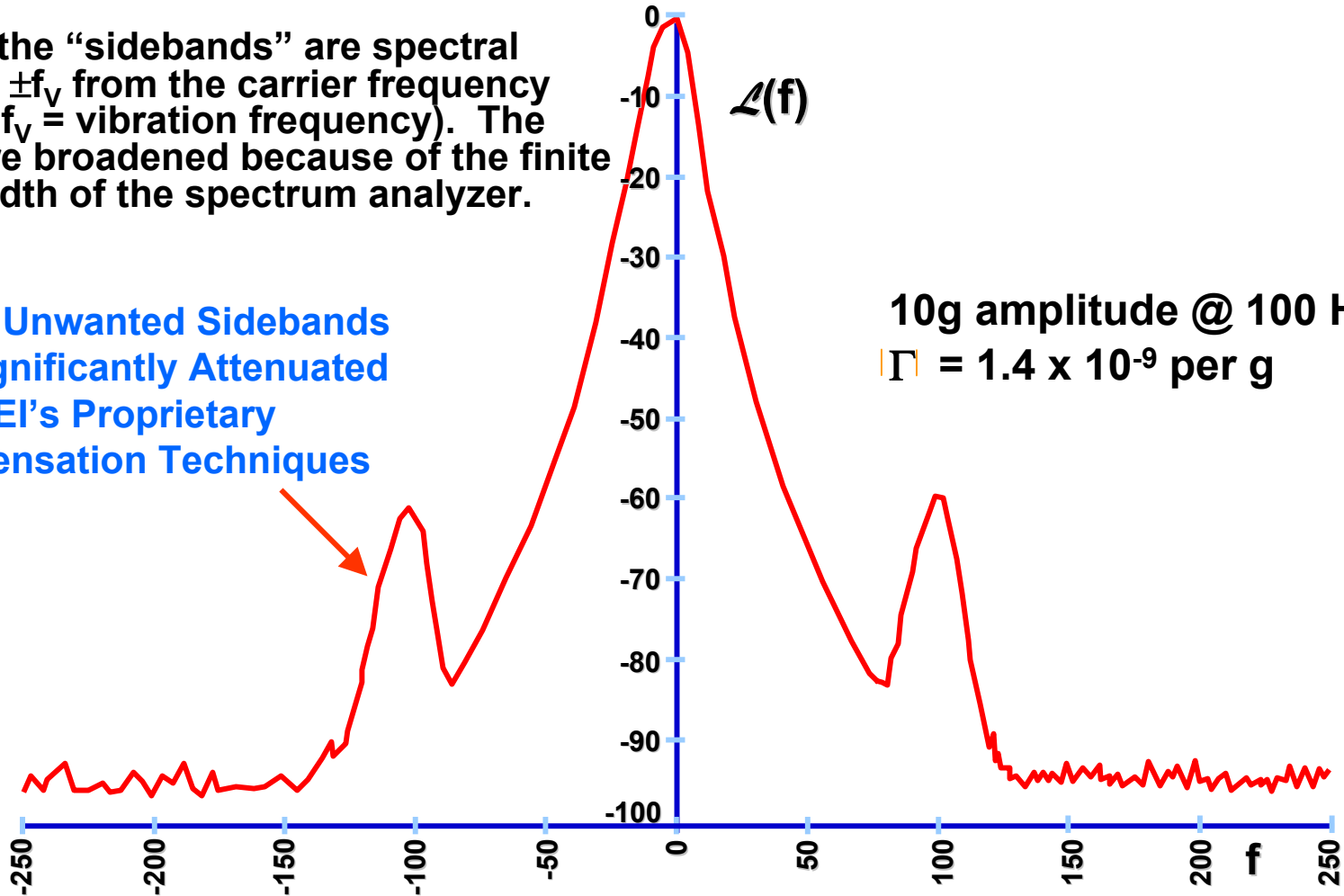



Vibration-Induced Sidebands After Frequency Multiplication

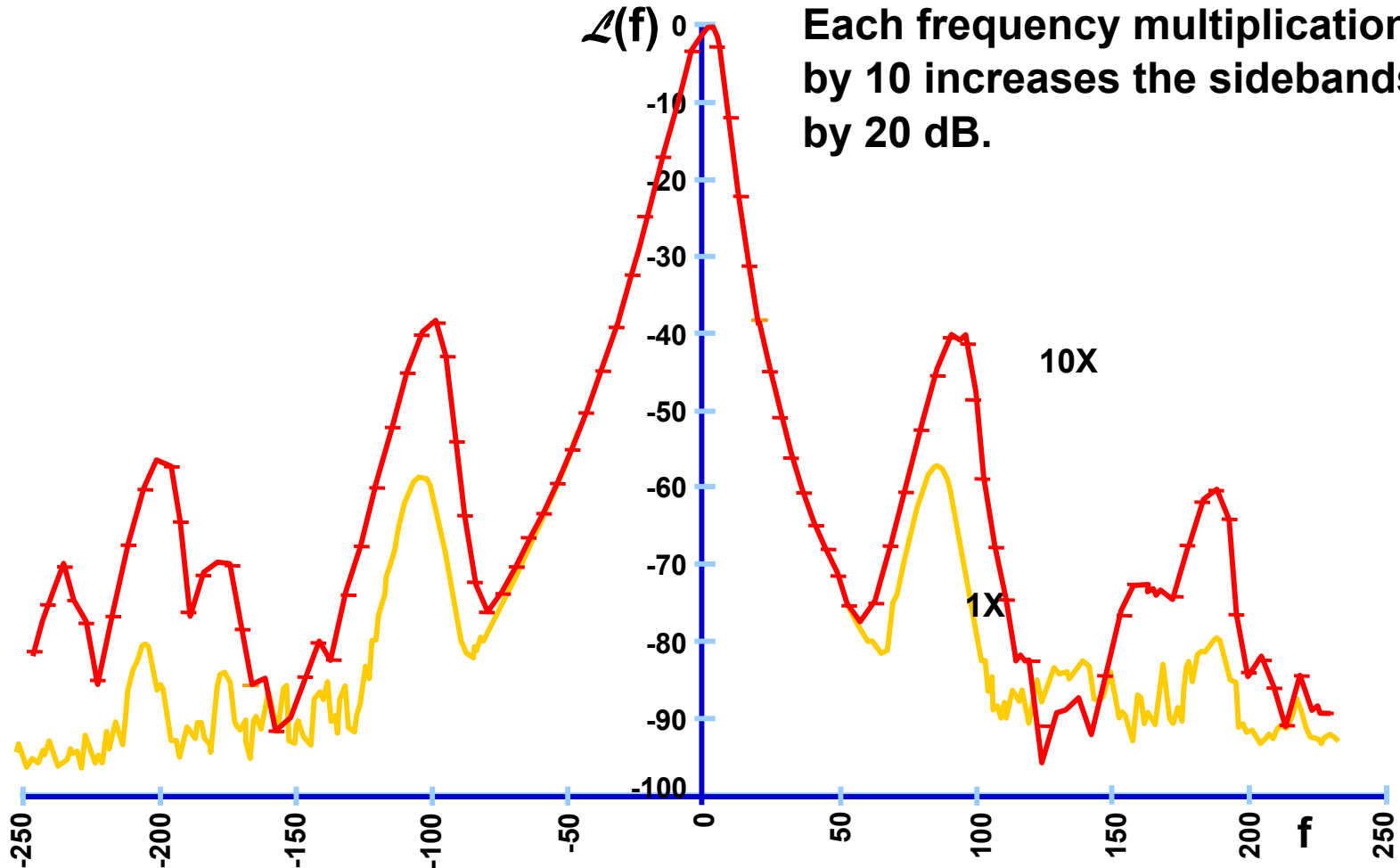



Vibration-Induced Phase Excursion

The phase of a vibration modulated signal is

$$\varphi(t) = 2\pi f_0 t + \left(\frac{\Delta f}{f_v} \right) \sin(2\pi f_v t)$$

When the oscillator is subjected to a sinusoidal vibration, the peak phase excursion is

$$\Delta \varphi_{\text{peak}} = \frac{\Delta f}{f_v} = \frac{(\bar{\Gamma} \bullet \bar{A}) f_0}{f_v}$$

Example: if a 10 MHz, $1 \times 10^{-9}/g$ oscillator is subjected to a 10 Hz sinusoidal vibration of amplitude 1g, the peak vibration-induced phase excursion is 1×10^{-3} radian. If this oscillator is used as the reference oscillator in a 10 GHz radar system, the peak phase excursion at 10GHz will be 1 radian. Such a large phase excursion can be catastrophic to the performance of many systems, such as those which employ phase locked loops (PLL) or phase shift keying (PSK).



Sine Vibration-Induced Phase Noise

Sinusoidal vibration produces spectral lines at $\pm f_v$ from the carrier, where f_v is the vibration frequency.

$$\mathcal{L}'(f_v) = 20 \log \left(\frac{\bar{\Gamma} \cdot \bar{A}f_0}{2f_v} \right)$$

e.g., if $\Gamma = 1 \times 10^{-9}/g$ and $f_0 = 10$ MHz, then even if the oscillator is completely noise free at rest, the phase “noise” i.e., the spectral lines, due solely to a sine vibration level of 1g will be;

Vibr. freq., f_v, in Hz	$\mathcal{L}'(f_v)$, in dBc
1	-46
10	-66
100	-86
1,000	-106
10,000	-126



Random Vibration-Induced Phase Noise

Random vibration's contribution to phase noise is given by:

$$\mathcal{L}(f) = 20 \log \left(\frac{\bar{\Gamma} \bullet \bar{A}f_0}{2f} \right), \quad \text{where } |\bar{A}| = [(2)(\text{PSD})]^{1/2}$$

e.g., if $\Gamma = 1 \times 10^{-9}/g$ and $f_0 = 10 \text{ MHz}$, then even if the oscillator is completely noise free at rest, the phase “noise” i.e., the spectral lines, due solely to a vibration PSD = 0.1 g²/Hz will be:

Offset freq., f, in Hz	$\mathcal{L}'(f)$, in dBc/Hz
1	-53
10	-73
100	-93
1,000	-113
10,000	-133



Typical Aircraft Random-Vibration-Induced Phase Noise

Phase noise under vibration is for $\Gamma = 1 \times 10^{-9}$ per g and $f = 10$ MHz

10 Mhz Random Vibration Single Sideband Phase Noise Utilizing 1E-9/g Csrystal

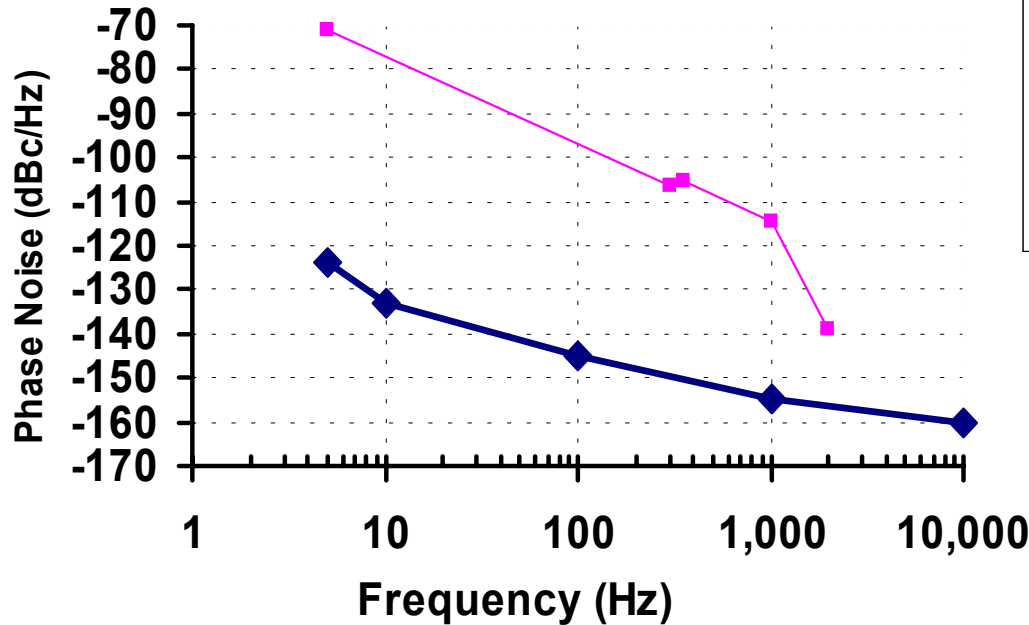

◆ L(f) No Vibration ■ L(f) With Shown Vibration

Typical Aircraft Random Vibration Envelope

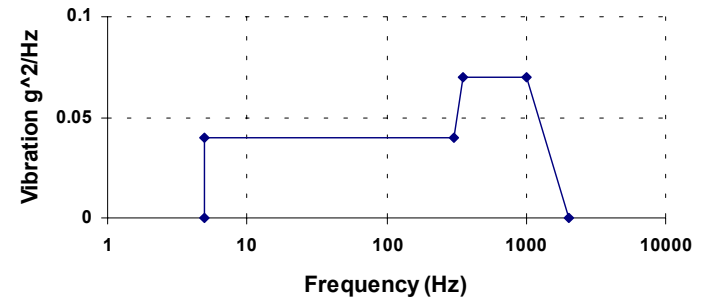

Vib freq Hz	Vib dens g^2/Hz
5	0
5	0.04
300	0.04
350	0.07
1000	0.07
2000	0



Phase Noise Degradation Due to Vibration

- Data shown is for a 10 MHz, 2×10^{-9} per g oscillator
- Radar spec. shown is for a coherent radar (e.g., SOTAS)

Impacts on Radar Performance

- Lower probability of detection
- Lower probability of identification
- Shorter range
- False targets

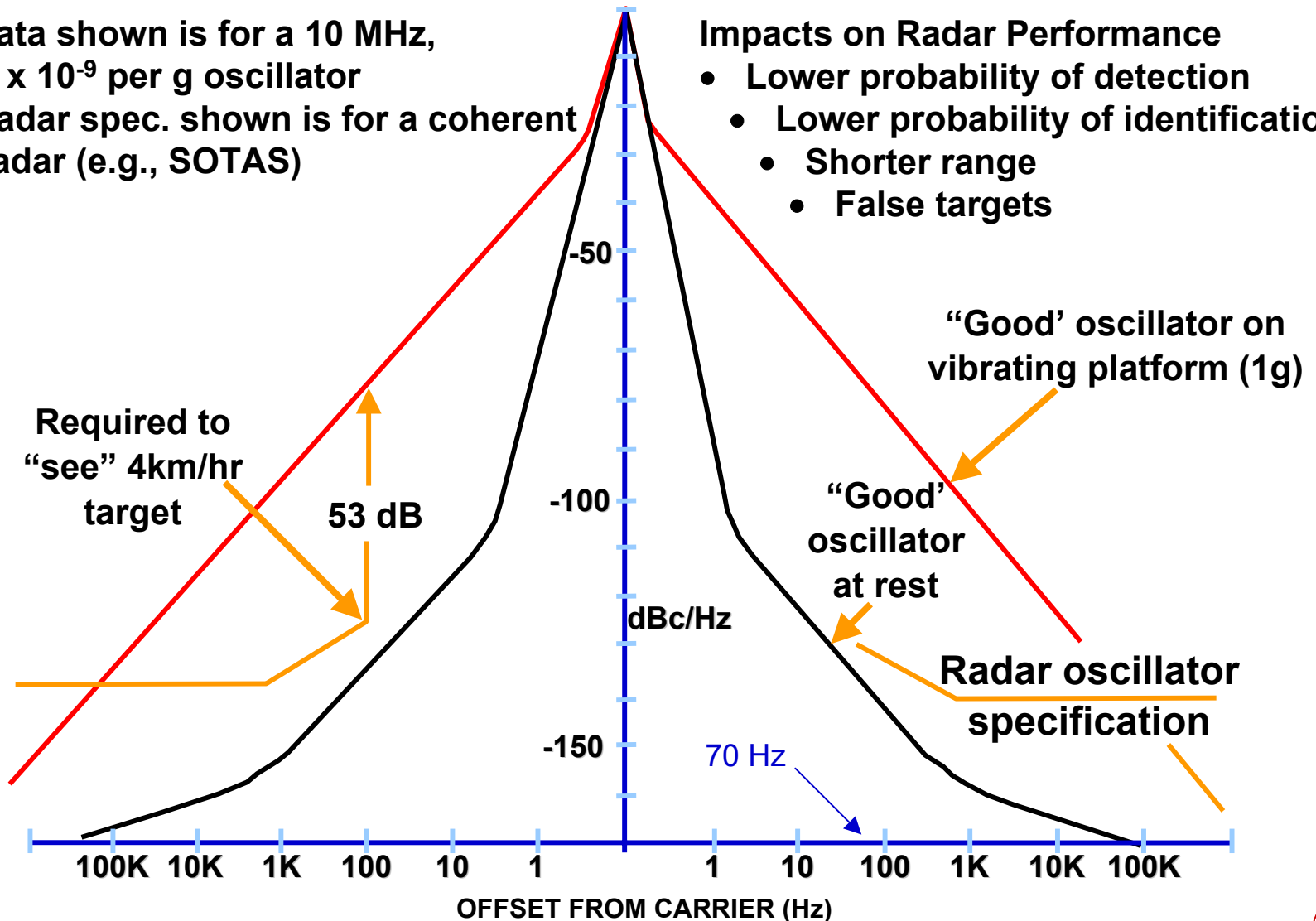



Coherent Radar Probability of Detection

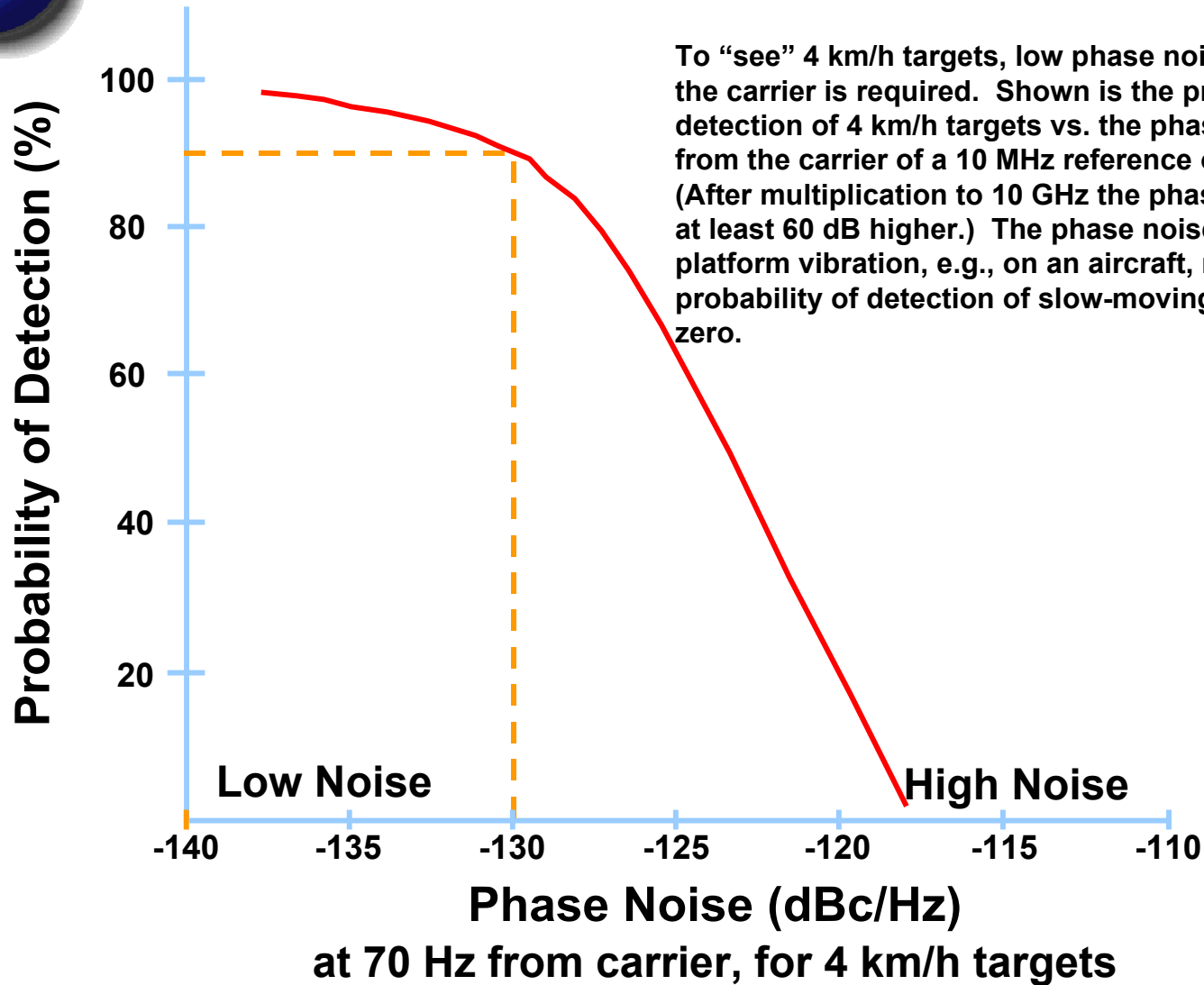

To “see” 4 km/h targets, low phase noise 70 Hz from the carrier is required. Shown is the probability of detection of 4 km/h targets vs. the phase noise 70 Hz from the carrier of a 10 MHz reference oscillator. (After multiplication to 10 GHz the phase noise will be at least 60 dB higher.) The phase noise due to platform vibration, e.g., on an aircraft, reduces the probability of detection of slow-moving targets to zero.



Rugged Clocks

- **Some applications require Rubidium Atomic Standards**
- **Other applications require only Crystal Oscillators**
- **Every Rubidium atomic Standard contains a crystal oscillator that determines its single side band phase noise under vibration**



Clocks are available as Rubidium Standards and/or as Crystal Oscillators

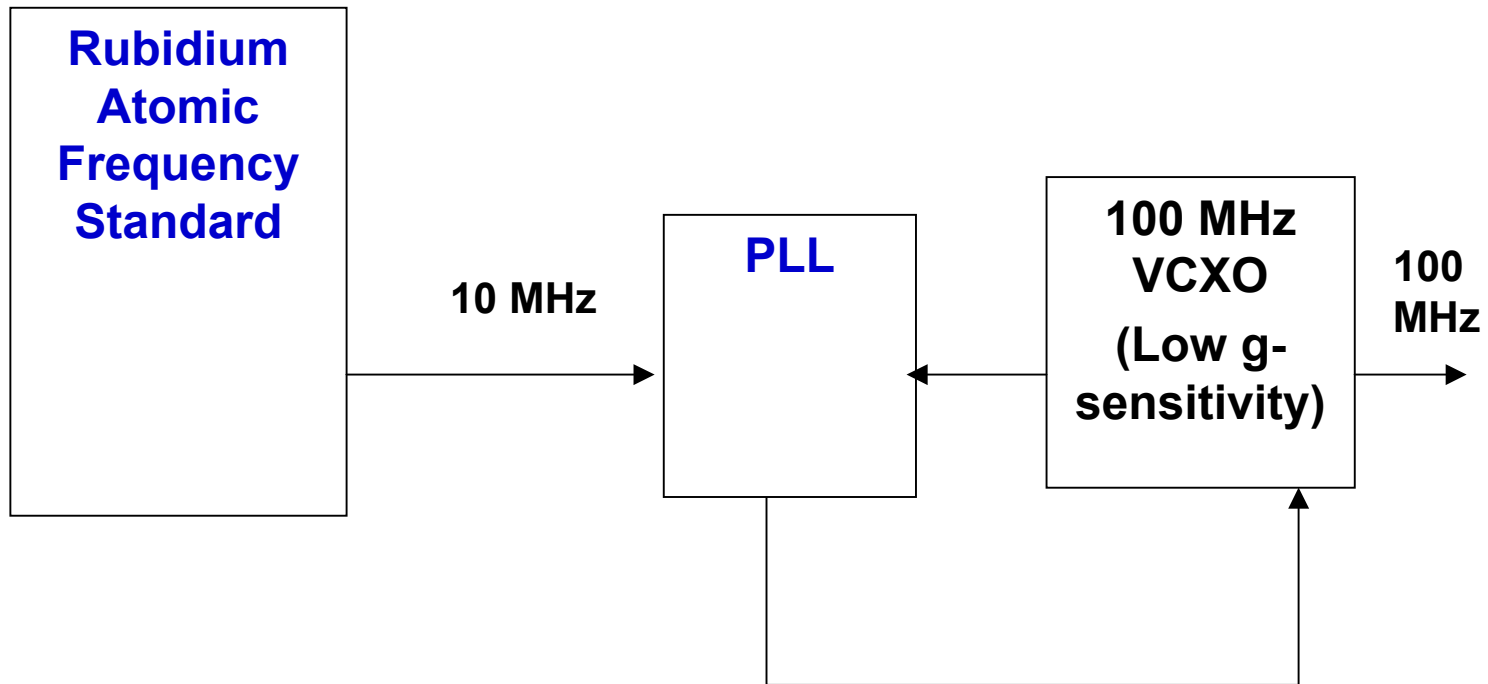



Rugged Clocks

- **Rubidium Standard must survive environmental conditions**
- **Rubidium Standard must not loose lock under any environmental conditions**
- **OCXO must provide the phase noise performance under vibration**
- **A phase lock loop with appropriate time constants must be cable of taking long term stability of Rubidium and not deteriorate the short term stability and spectral purity of OCXO**
- **All components of this frequency and time system must operate under all specified environmental conditions**
- **Must be producible and affordable**



G-Sensitivity of Quartz Resonators

- Quartz resonators exhibit an inherent g-sensitivity—they are good accelerometers
- Present crystal technology:
 - 1E-9/g typical
 - 3E-10/g low yield and expensive
 - 2E-10/g state-of-the-art



Breakthrough in G-Sensitivity

- **Develop of a SC-cut resonator with minimum cross axis coupling**
- **Typical g-sensitivity of $1\text{E-}10/\text{g}$**
- **Broadband compensation technique from DC to 2 KHz**
- **Improvements of 30dB typical**
- **Compensation is independent of:**
 - **Temperature**
 - **Nominal setting of oscillator frequency**
 - **Aging of components in frequency feedback loop**



Objectives

- **Achieve:**
 - 2E-12/g
 - Economies in manufacturability
 - Small package $\approx 3 \text{ in}^3$
- **Combination of low g-sensitivity technology with vibration isolators to accomplish above performance from DC to 2 KHz**
- **The technology is also applicable to Rubidium Standards in moving/vibrating platforms (vibration induced errors in Rb standards is solely due to crystals imbedded in the Rb design)**



Applications

- **FEI's recent breakthrough in highly reproducible low-G sensitivity oscillators that are virtually insensitive to acceleration/vibration has resulted in a host of applications:**
 - **Precision Navigation**
 - **Radar for helicopters and other challenging platforms**
 - **Commercial and Secure communications**
 - **Space exploration**
 - **Target acquisition**
 - **Munitions and Missile guidance**
 - **SATCOM terminals**
 - **All other applications where the effects of acceleration or vibration effect the output signal of the oscillator**



AXIS DEFINITIONS

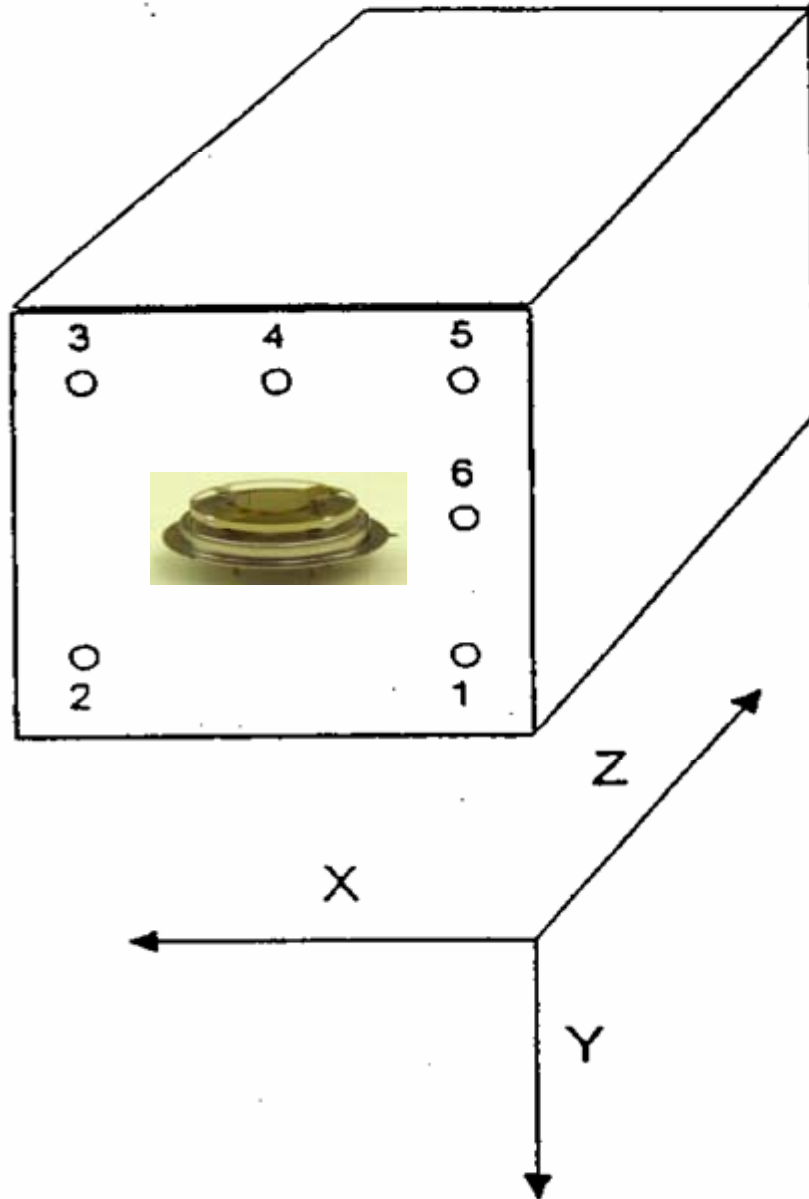



DYNAMIC PHASE NOISE FOR 10.0MHZ OCXO UN. 20 X-AXIS

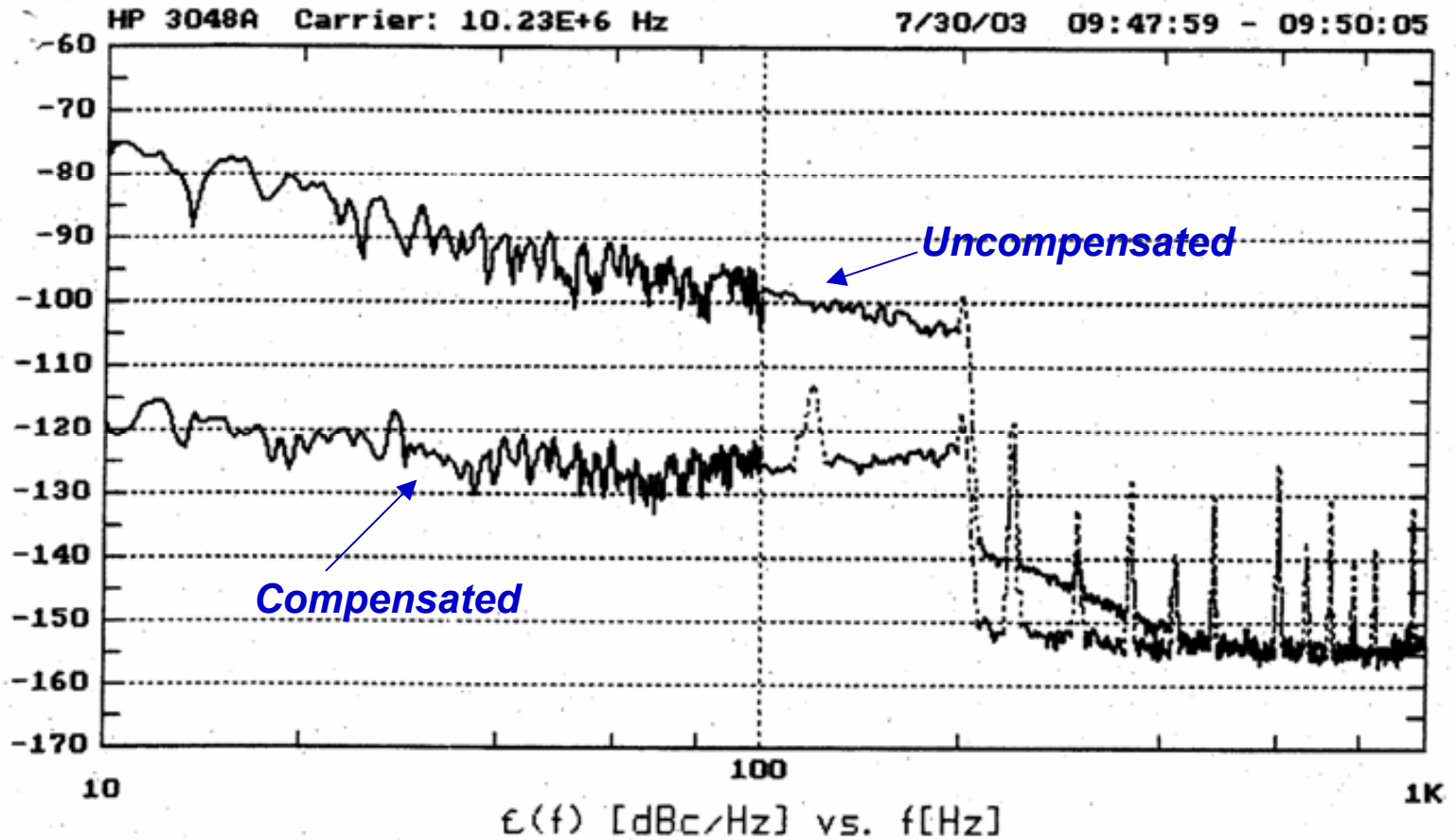

Vibration Profile: 4 g RMS total, Random; 0.08g²/Hz 10 to 200 Hz

	Approximate Sensitivity per g		
	10 Hz	50 Hz	100 Hz
Uncompensated	1.1×10^{-9}	7.9×10^{-10}	8.9×10^{-10}
Compensated	6.3×10^{-12}	2.2×10^{-11}	4.0×10^{-11}



DYNAMIC PHASE NOISE FOR 10.0MHZ OCXO UN. 20 Y-AXIS

HP 3048A Carrier: 10.23E+6 Hz

7/30/03 10:14:03 - 10:16:09

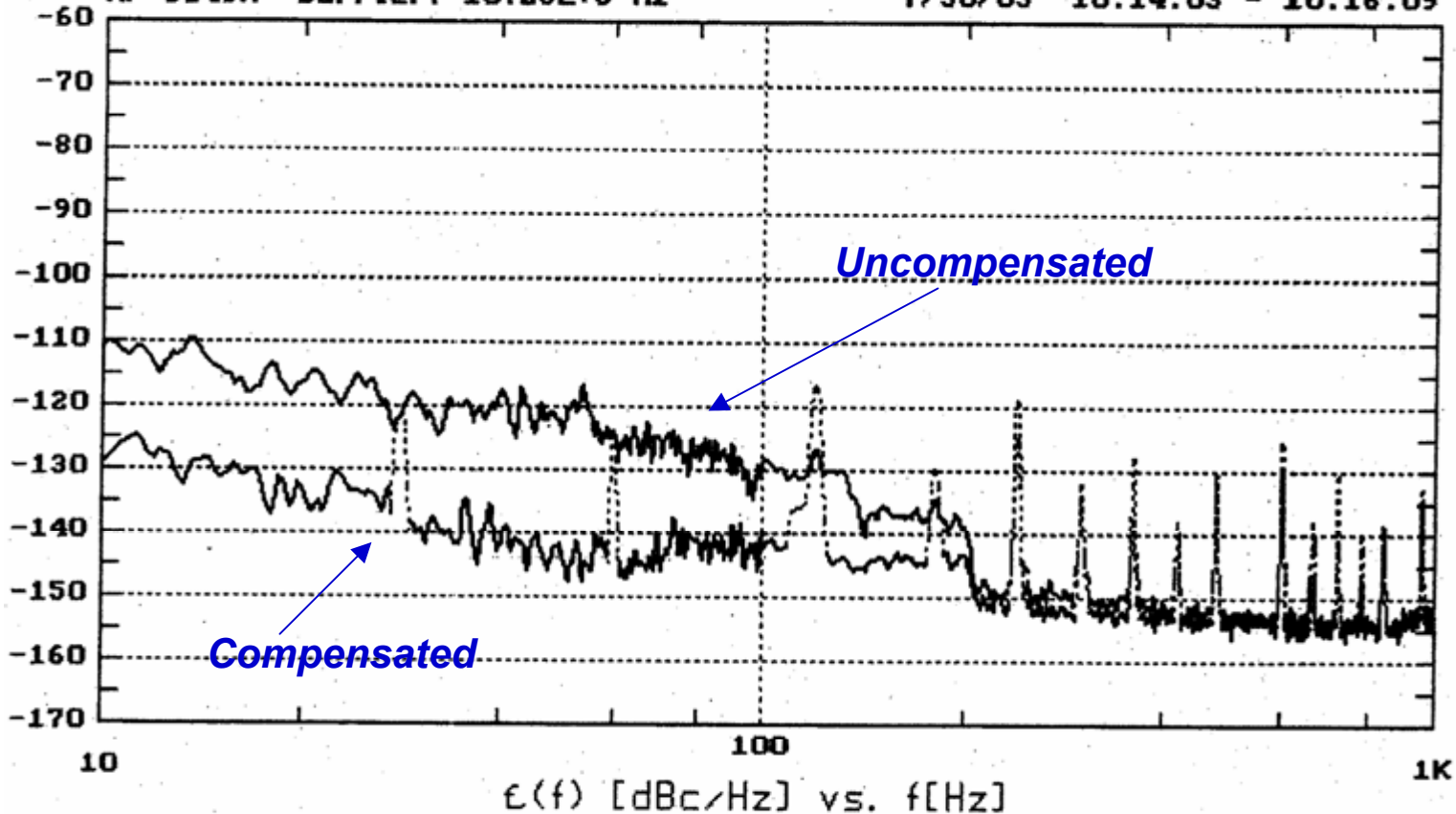

Vibration Profile: 4 g RMS total, Random; 0.08g²/Hz 10 to 200 Hz

Approximate Sensitivity per g

	10 Hz	50 Hz	100 Hz
Uncompensated	2.2×10^{-11}	2.8×10^{-11}	2.2×10^{-11}
Compensated	2.8×10^{-12}	2.5×10^{-12}	5.0×10^{-12}

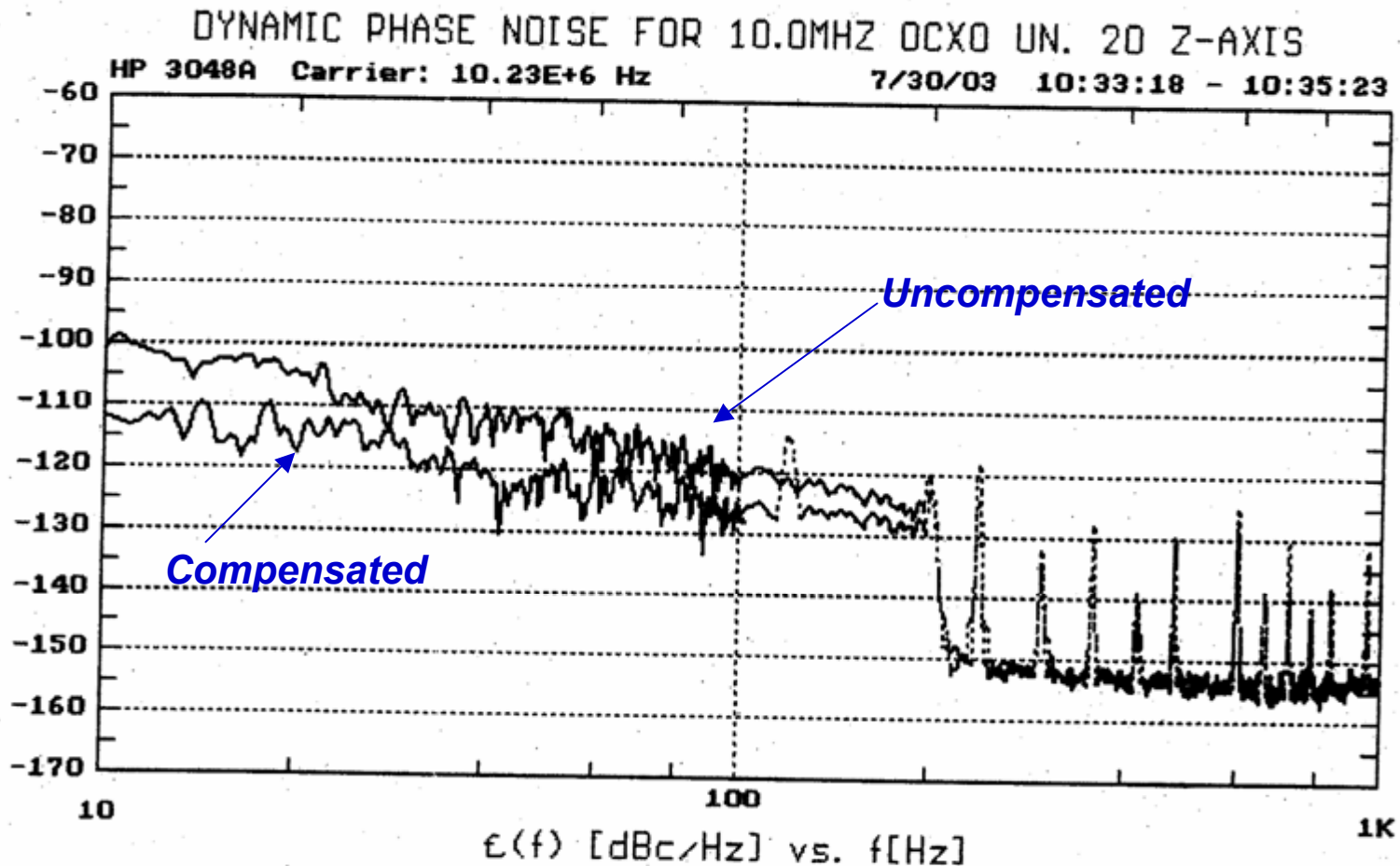

Vibration Profile: 4 g RMS total, Random; 0.08g²/Hz 10 to 200 Hz

	Approximate Sensitivity per g		
	10 Hz	50 Hz	100 Hz
Uncompensated	7.0×10^{-11}	8.9×10^{-11}	7.0×10^{-11}
Compensated	1.8×10^{-11}	3.1×10^{-11}	3.5×10^{-11}



Broadband Vibration

$0.008g^2/Hz$ 10 Hz to 1 KHz

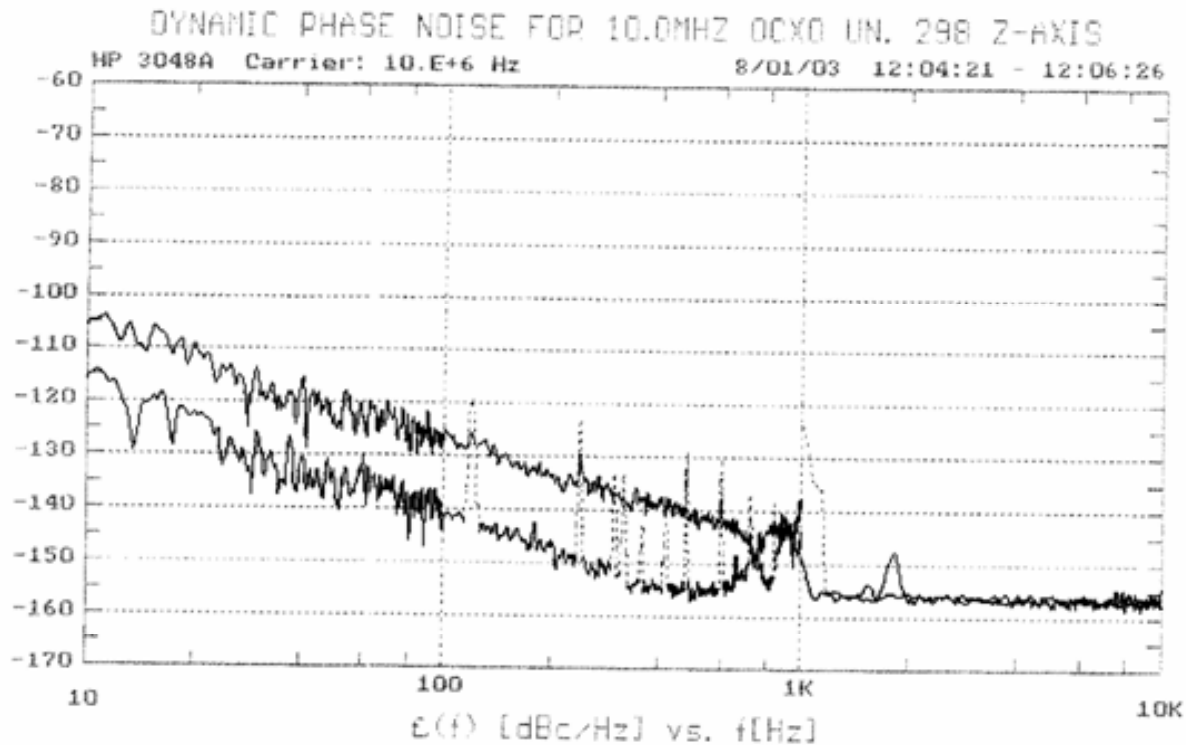

Note: Fixture resonance observed at ≈ 900 Hz



Typical Aircraft Random-Vibration-Induced Phase Noise

Phase noise under vibration is for $\Gamma = 1 \times 10^{-9}$ per g , $\Gamma = 1 \times 10^{-10}$ per g , $\Gamma = 2 \times 10^{-12}$ per g and $f = 10$ MHz.

10 MHz Random Vibration Single Sideband Phase

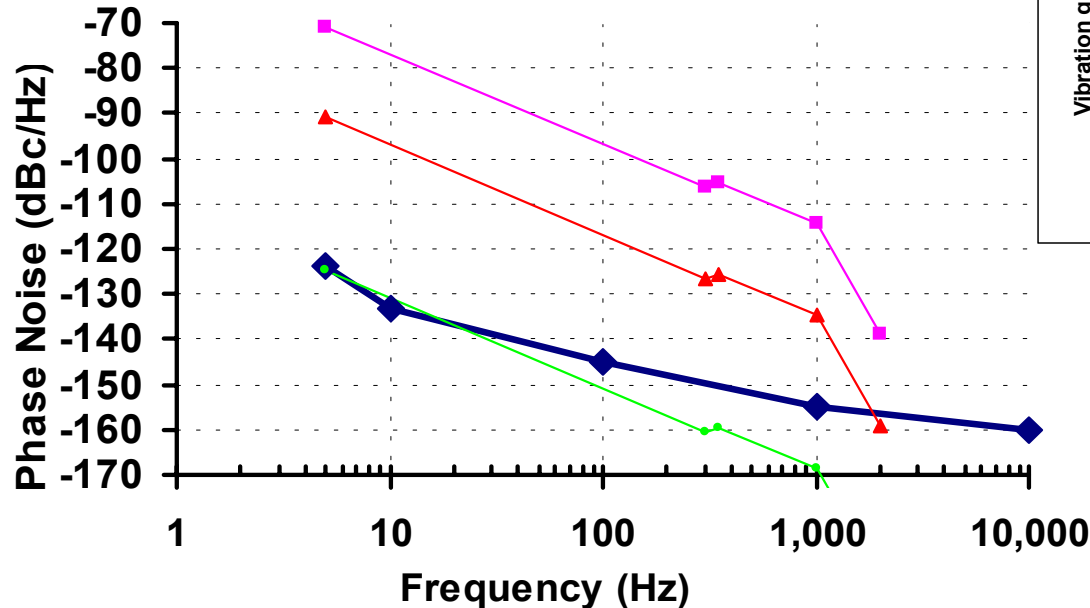

Typical Aircraft Random Vibration Envelope

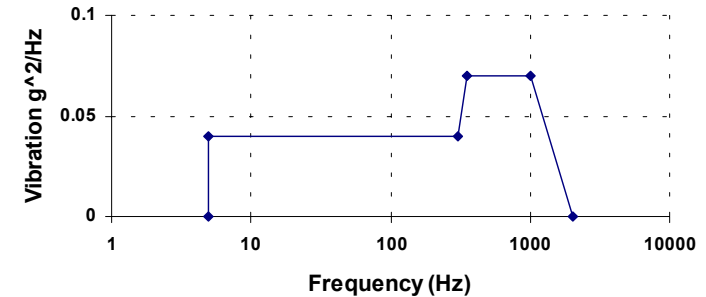

Vib freq Hz	Vib dens g^2/Hz
5	0
5	0.04
300	0.04
350	0.07
1000	0.07
2000	0

- ◆ L(f) No Vibration
- L(f) With Shown Vibration and Crystal Gamma of 1E-9/g
- ▲ L(f) With Shown Vibration and Crystal Gamma of 1E-10/g
- L(f) With Shown Vibration and Crystal Gamma of 2E-12/g



Typical Helicopter Random-Vibration-Induced Phase Noise

Phase noise under vibration is for $\Gamma = 1 \times 10^{-9}$ per g, $\Gamma = 5 \times 10^{-11}$ per g and $f = 10$ MHz. To meet the specification a $\Gamma = 5 \times 10^{-12}$ per g or better is required. Close to carrier noise is reduced using FEI's low-g sensitivity breakthrough, and above 200 Hz vibration isolation is required(see next slide).

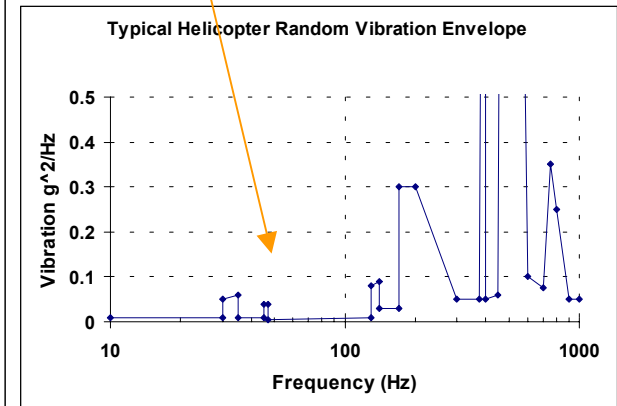
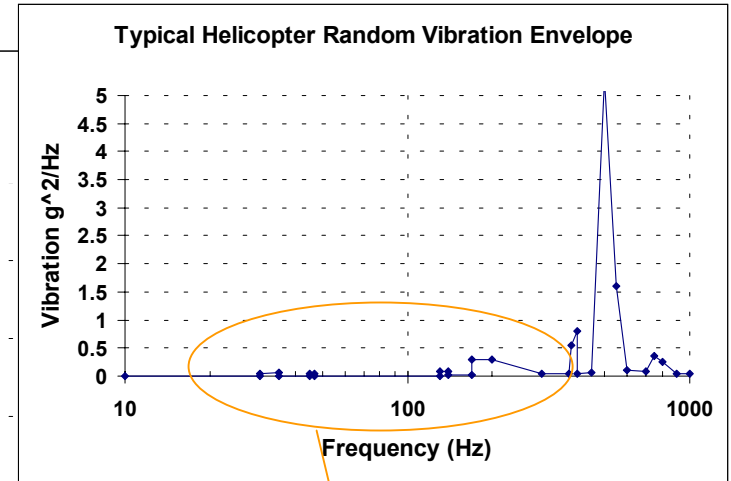
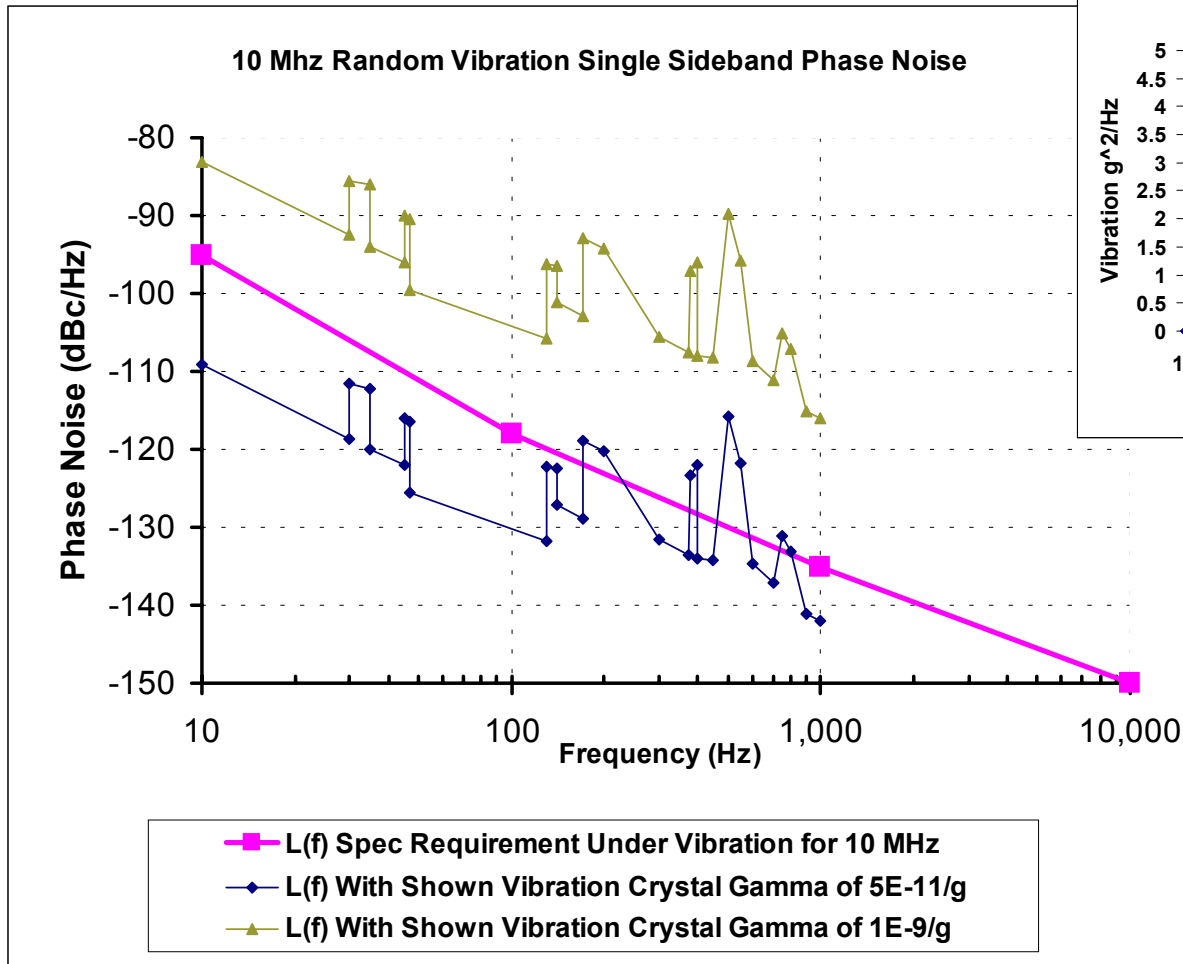



Typical Helicopter Random-Vibration-Induced Phase Noise

Phase noise under vibration is for $\Gamma = 5 \times 10^{-11}$ per g and $f = 10$ MHz. Close to carrier noise is reduced using FEI's low-g sensitivity breakthrough, and above 200 Hz vibration isolation are utilized. Vibration Isolators are chosen with resonance frequency of $\cong 70$ Hz with damping factor of 0.3 and $\cong -6$ dB mechanical damping factor per octave.

10 Mhz Random Vibration Single Sideband Phase Noise Utilizing a Crystal with a Gamma of 5E-11/g and Vibration Isolators

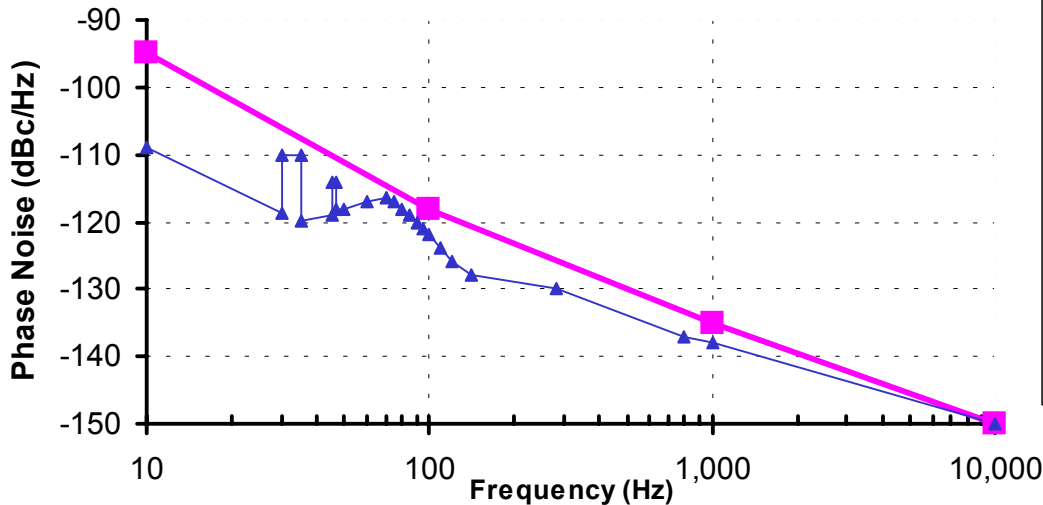

- L(f) Spec Requirement Under Vibration for 10 MHz
- ▲— L(f) Under Vibration With Crystal Gamma of 5E-11/g and Vibration Isolators

10 Mhz Random Vibration Single Sideband Phase Noise Utilizing a Crystal with a Gamma of 5E-11/g

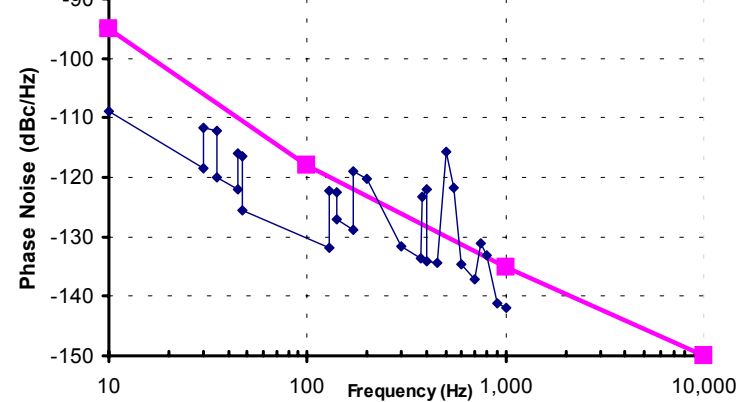

- L(f) Spec Requirement Under Vibration for 10 MHz
- ◆— L(f) With Shown Vibration Crystal Gamma of 5E-11/g

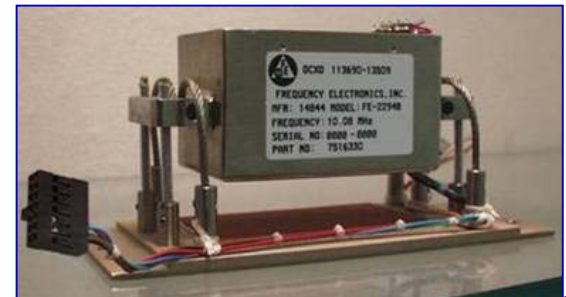



Summary: Clocks for Challenging Environments

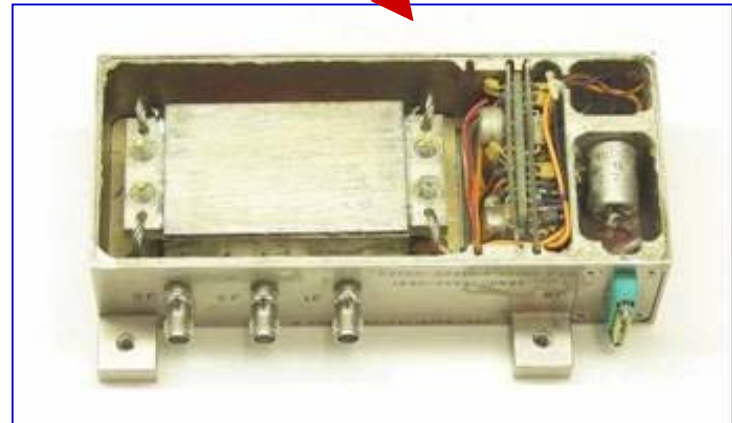
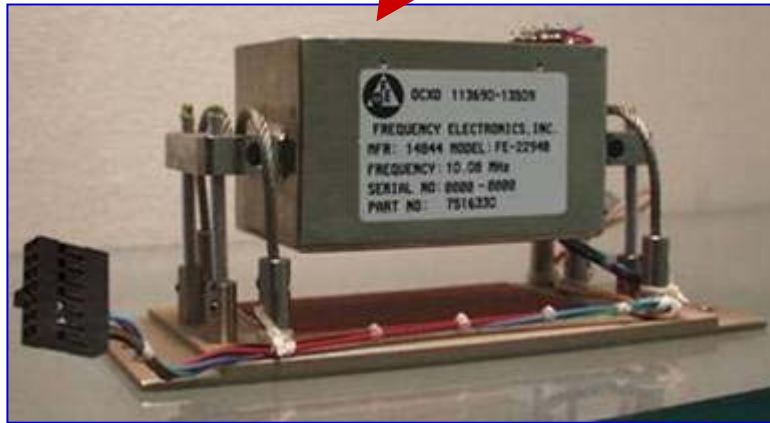

Low G-Sensitivity Clocks

- Internal FEI proprietary compensation techniques to reduce g-sensitivity
- Vibration isolation mounts may be required