

NUMERICAL ELECTROMAGNETICS CODE (NEC) -
METHOD OF MOMENTS

PART III: USER'S GUIDE

G. J. Burke
A. J. Poggio

January 1981

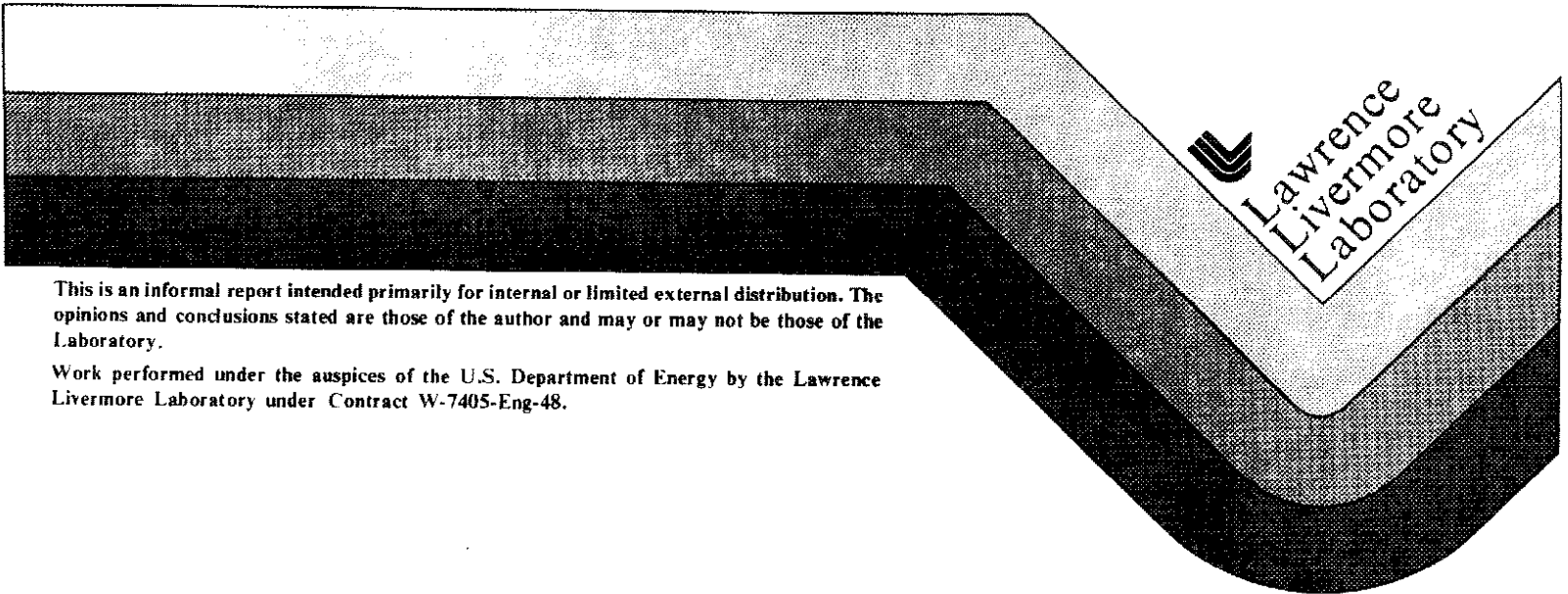

This is an informal report intended primarily for internal or limited external distribution. The opinions and conclusions stated are those of the author and may or may not be those of the Laboratory.

Work performed under the auspices of the U.S. Department of Energy by the Lawrence Livermore Laboratory under Contract W-7405-Eng-48.

DISCLAIMER (From the original NEC document)

This document was prepared as an account of work sponsored by an agency of the United States Government. Neither the United States Government nor the University of California nor any of their employees, makes any warranty, express or implied, or assumes any legal liability or responsibility for the accuracy, completeness, or usefulness of any information, apparatus, product, or process disclosed, or represents that its use would not infringe privately owned rights. Reference herein to any specific commercial products, process, or service by trade name, trademark, manufacturer, or otherwise does not necessarily constitute or imply its endorsement, recommendation, or favoring by the United States Government or the University of California. The views and opinions of authors expressed herein do not necessarily state or reflect those of the United States Government or the University of California, and shall not be used for advertising or product endorsement purposes.

The NEC2 documentation is composed of three sections

Part I: Program Description - Theory
Part II: Program Listing
Part III: User's guide

And may be obtained from the
National Technical Information Service (U.S. Department of Commerce)
5285 Port Royal Road
Springfield, VA 22161

Fax: +1 (703) 321 8547
Tel: +1 (703) 487 4679
<http://www.ntis.gov>

Ordering codes: AD-A075 209, AD-A075 289 and AD-A075 460 (not sure which is which)

January 2001

This document (Part III) was downsampled to 200DPI from a 300DPI bi-level bitmap on a high-speed scanner, and reformatted to fit in a US-Letter format page.

I make no representation whatsoever as to the usefulness or exactitude of this file.

Have fun!

Alexandre Kampouris, Montréal E-Mail: ak@Radio-BIP.qc.ca

Preface

The Numerical Electromagnetics Code (NEC) has been developed at the Lawrence Livermore Laboratory, Livermore, California, under the sponsorship of the Naval Ocean Systems Center and the Air Force Weapons Laboratory. It is an advanced version of the Antenna Modeling Program (AMP) developed in the early 1970's by MBAssociates for the Naval Research Laboratory, Naval Ship Engineering Center, U.S. Army ECOM/Communications Systems, U.S. Army Strategic Communications Command, and Rome Air Development Center under Office of Naval Research Contract N00014-71-C-0187. The present version of NEC is the result of efforts by G. J. Burke and A. J. Poggio of Lawrence Livermore Laboratory.

The documentation for NEC consists of three volumes:

- Part I: NEC Program Description -- Theory
- Part II: NEC Program Description -- Code
- Part III: NEC User's Guide

The documentation has been prepared by using the AMP documents as foundations and by modifying those as needed. In some cases this led to minor changes in the original documents while in many cases major modifications were required.

Over the years many individuals have been contributors to AMP and NEC and are acknowledged here as follows:

R. W. Adams	R. J. Lytle
J. N. Brittingham	E. K. Miller
G. J. Burke	J. B. Morton
F. J. Deadrick	G. M. Pjerrou
K. K. Hazard	A. J. Poggio
D. L. Knepp	E. S. Selden
D. L. Lager	

The support for the development of NEC-2 at the Lawrence Livermore Laboratory has been provided by the Naval Ocean Systems Center under MIPR-N0095376MP. Cognizant individuals under whom this project was carried out include: J. Rockway and J. Logan. Previous development of NEC also included the support of the Air Force Weapons Laboratory (Project Order 76-090) and was monitored by J. Castillo and TSgt. H. Goodwin.

Work was performed under the auspices of the U.S. Department of Energy under contract No. W-7405-Eng-48. Reference to a company or product name does not imply approval or recommendation of the product by the University

of California or the U.S. Department of Energy to the exclusion of others that may be suitable.

Contents

<u>Section</u>	<u>Page</u>
	LIST OF ILLUSTRATIONS v
I.	INTRODUCTION 1
II.	STRUCTURE MODELING GUIDELINES 3
	1. Wire Modeling 3
	2. Surface Modeling 6
	3. Modeling Structures Over Ground 11
III.	PROGRAM INPUT 14
	1. Comment Cards 15
	2. Structure Geometry Input 16
	Wire Arc Specification (GA) 18
	End Geometry Input (GE) 19
	Read NGF File (GF) 21
	Coordinate Transformation (GM) 22
	Generate Cylindrical Structure (GR) 24
	Scale Structure Dimensions (GS) 27
	Wire Specification (GW) 28
	Reflection in Coordinate Planes (GX) 31
	Surface Patch (SP) 34
	Multiple Patch Surface (SM) 38
	Examples of Structure Geometry Data 40
	3. Program Control Cards 47
	Maximum Coupling Calculation (CP) 50
	Extended Thin-Wire Kernel (EK) 51
	End of Run (EN) 52
	Excitation (EX) 53
	Frequency (FR) 58
	Additional Ground Parameters (GD) 60
	Ground Parameters (GN) 62
	Interaction Approximation Range (KH) 65
	Loading (LD) 66
	Near Fields (NE, NH) 69
	Networks (NT) 72
	Next Structure (NX) 75
	Print Control for Charge on Wires (PQ) 76

<u>Section</u>	<u>Page</u>
Print Control for Current on Wires (PT)	77
Radiation Pattern (RP)	79
Transmission Line (TL)	84
Write NGF File (WG)	86
Execute (XQ)	87
4. SOMNEC Input for Sommerfeld/Norton Ground Method	89
5. The Numerical Green's Function Option	89
IV. NEC OUTPUT	93
Examples 1 through 4	95
Example 5, Log-Periodic Antenna	115
Example 6, Cylinder with Attached Wires	123
Examples 7 and 8, Scattering by a Wire and Aircraft	133
Example 9, Scattering by a Sphere	143
Example 10, Monopole on Radial Wire Ground Screen	153
V. EXECUTION TIME	165
VI. DIFFERENCES BETWEEN NEC-2, NEC-1, AND AMP2	167
VII. FILE STORAGE REQUIREMENTS	169
VIII. ERROR MESSAGES	172
REFERENCES	179

List of Illustrations

<u>Figure</u>		<u>Page</u>
1.	Patch Position and Orientation	7
2.	Connection of a Wire to a Surface Patch	8
3.	Patch Models for a Sphere	9
4.	Bistatic RCS of a Sphere with $ka = 5.3$	10
5.	Surface Patch Options	36
6.	Rectangular Surface Covered by Multiple Patches	39
7.	Rhombic Antenna — No Symmetry	40
8.	Rhombic Antenna — 2 Planes of Symmetry	41
9.	Rhombic Antenna — 1 Plane of Symmetry	42
10.	Coaxial Rings	42
11.	Wire Grid Plate and Dipole	43
12.	Development of Surface Model for Cylinder with Attached Wires	45
13.	Segmentation of Cylinder for Wires Connected to End and Side	46
14.	Specification of Incident Wave	55
15.	Orientation of Current Element	56
16.	Parameters for a Second Ground Medium	60
17.	Segment Loaded by Means of a 2-Port Network	74
18.	Coordinates for Radiated Field	80
19.	Stick Model of Aircraft	133

Abstract

The Numerical Electromagnetics Code (NEC-2) is a computer code for analyzing the electromagnetic response of an arbitrary structure consisting of wires and surfaces in free space or over a ground plane. The analysis is accomplished by the numerical solution of integral equations for induced currents. The excitation may be an incident plane wave or a voltage source on a wire, while the output may include current and charge density, electric or magnetic field in the vicinity of the structure, and radiated fields. NEC-2 includes several features not contained in NEC-1, including an accurate method for modeling grounds, based on the Sommerfeld integrals, and an option to modify a structure without repeating the complete solution.

This manual contains instruction for use of the Code, including preparation of input data and interpretation of the output. Examples are included that show typical input and output and illustrate many of the special options available in NEC-2. The examples exercise most parts of the Code and, hence, may also be used to check that the Code is operating correctly. Two other manuals for NEC-2, covering the equations and details of the coding, are referenced.

Section I Introduction

The Numerical Electromagnetics Code (NEC-2) is a user-oriented computer code for analysis of the electromagnetic response of antennas and other metal structures. It is built around the numerical solution of integral equations for the currents induced on the structure by sources or incident fields. This approach avoids many of the simplifying assumptions required by other solution methods and provides a highly accurate and versatile tool for electromagnetic analysis.

The code combines an integral equation for smooth surfaces with one specialized to wires to provide for convenient and accurate modeling of a wide range of structures. A model may include nonradiating networks and transmission lines connecting parts of the structure, perfect or imperfect conductors, and lumped element loading. A structure may also be modeled over a ground plane that may be either a perfect or imperfect conductor.

The excitation may be either voltage sources on the structure or an incident plane wave of linear or elliptic polarization. The output may include induced currents and charges, near electric or magnetic fields, and radiated fields. Hence, the program is suited to either antenna analysis or scattering and EMP studies.

The integral equation approach is best suited to structures with dimensions up to several wavelengths. Although there is no theoretical size limit, the numerical solution requires a matrix equation of increasing order as the structure size is increased relative to wavelength. Hence, modeling very large structures may require more computer time and file storage than is practical on a particular machine. In such cases standard high-frequency approximations such as geometrical optics, physical optics, or geometrical theory of diffraction may be more suitable than the integral equation approach used in NEC-2.

NEC-2 retains all features of the earlier version NEC-1 except for a restart option. Major additions in NEC-2 are the Numerical Green's Function for partitioned-matrix solution and a treatment for lossy grounds that is accurate for antennas very close to the ground surface. NEC-2 also includes an option to compute maximum coupling between antennas and new options for structure input.

This manual contains instructions for use of the NEC-2 code and sample runs to illustrate the output. The sample runs may also be used as a standard to check the operation of a newly duplicated or modified deck. There are two other manuals for NEC-2: Part I: NEC Program Description - Theory (ref. 1); and Part II: NEC Program Description - Code (ref. 2). Part I covers the equations and numerical methods, and Part II is a detailed description of the Fortran code.

Section II

Structure Modeling Guidelines

The basic devices for modeling structures with the NEC code are short, straight segments for modeling wires and flat patches for modeling surfaces. An antenna and any other conducting objects in its vicinity that affect its performance must be modeled with strings of segments following the paths of wires and with patches covering surfaces. Proper choice of the segments and patches for a model is the most critical step to obtaining accurate results. The number of segments and patches should be the minimum required for accuracy, however, since the program running time increases rapidly as this number increases. Guidelines for choosing segments and patches are given below and should be followed carefully by anyone using the NEC code. Experience gained by using the code will also aid the user in developing models.

1. WIRE MODELING

A wire segment is defined by the coordinates of its two end points and its radius. Modeling a wire structure with segments involves both geometrical and electrical factors. Geometrically, the segments should follow the paths of conductors as closely as possible, using a piece-wise linear fit on curves.

The main electrical consideration is segment length Δ relative to the wavelength λ . Generally, Δ should be less than about 0.1λ at the desired frequency. Somewhat longer segments may be acceptable on long wires with no abrupt changes while shorter segments, 0.05λ or less, may be needed in modeling critical regions of an antenna. The size of the segments determines the resolution in solving for the current on the model since the current is computed at the center of each segment. Extremely short segments, less than about $10^{-3} \lambda$, should also be avoided since the similarity of the constant and cosine components of the current expansion leads to numerical inaccuracy.

The wire radius, a , relative to λ is limited by the approximations used in the kernel of the electric field integral equation. Two approximation options are available in NEC: the thin-wire kernel and the extended thin-wire kernel. These are discussed in reference 1. In the thin-wire kernel, the current on the surface of a segment is reduced to a filament of current on the segment axis. In the extended thin-wire kernel, a current uniformly distributed around the segment surface is assumed. The field of this current is approximated by the first two terms in a series expansion of the exact field

in powers of a^2 . The first term in the series, which is independent of a , is identical to the thin-wire kernel while the second term extends the accuracy for larger values of a . Higher order approximations are not used because they would require excessive computation time.

In either of these approximations, only currents in the axial direction on a segment are considered, and there is no allowance for variation of the current around the wire circumference. The acceptability of these approximations depends on both the value of a/λ and the tendency of the excitation to produce circumferential current or current variation. Unless $2\pi a/\lambda$ is much less than 1, the validity of these approximations should be considered.

The accuracy of the numerical solution for the dominant axial current is also dependent on Δ/a . Small values of Δ/a may result in extraneous oscillations in the computed current near free wire ends, voltage sources, or lumped loads. Use of the extended thin-wire kernel will extend the limit on Δ/a to smaller values than are permissible with the normal thin-wire kernel. Studies of the computed field on a segment due to its own current have shown that with the thin-wire kernel, Δ/a must be greater than about 8 for errors of less than 1%. With the extended thin-wire kernel, Δ/a may be as small as 2 for the same accuracy (ref. 3). In the current solution with either of these kernels, the error tends to be less than for a single field evaluation. Reasonable current solutions have been obtained with the thin-wire kernel for Δ/a down to about 2 and with the extended thin-wire kernel for Δ/a down to 0.5. When a model includes segments with Δ/a less than about 2, the extended thin-wire kernel option should be used by inclusion of an EK card in the data deck.

When the extended thin-wire kernel option is selected, it is used at free wire ends and between parallel, connected segments. The normal thin-wire kernel is always used at bends in wires, however. Hence, segments with small Δ/a should be avoided at bends. Use of a small Δ/a at a bend, which results in the center of one segment falling within the radius of the other segment, generally leads to severe errors.

The current expansion used in NEC enforces conditions on the current and charge density along wires, at junctions, and at wire ends. For these conditions to be applied properly, segments that are electrically connected must have coincident end points. If segments intersect other than at their ends, the NEC code will not allow current to flow from one segment to the other. Segments will be treated as connected if the separation of their ends is less

than about 10^{-3} times the length of the shortest segment. When possible, however, identical coordinates should be used for connected segment ends.

The angle of the intersection of wire segments in NEC is not restricted in any manner. In fact, the acute angle may be so small as to place the observation point on one wire segment within the volume of another wire segment. Numerical studies have shown that such overlapping leads to meaningless results; thus, as a minimum, one must ensure that the angle is large enough to prevent overlaps. Even with such care, the details of the current distribution near the intersection may not be reliable even though the results for the current may be accurate at distances from this region.

NEC includes a patch option for modeling surfaces using the magnetic-field integral equation. This formulation is restricted to closed surfaces with nonvanishing enclosed volume. For example, it is not theoretically applicable to a conducting plate of zero thickness and, actually, the numerical algorithm is not practical for thin bodies (such as solar panels). The latter difficulty is due to the possibility of poor conditioning of the matrix equation.

Wire-grid modeling of conducting surfaces has been used with varying success. The earliest applications to the computation of radar cross sections and radiation patterns provided reasonably accurate results. Even computations for the input impedance of antennas driven against grid models of surfaces have oftentimes exhibited good agreement with experiments. However, broad and generalized guidelines for near-field quantities have not been developed, and the use of wire-grid modeling for near-field parameters should be approached with caution. A single wire grid, however, may represent both surfaces of a thin conducting plate. The current on the grid will be the sum of the currents that would flow on opposite sides of the plate. While information on the currents on the individual surfaces is lost, the grid will yield the correct radiated fields.

Other rules for the segment model follow:

- Segments (or patches) may not overlap since the division of current between two overlapping segments is indeterminate. Overlapping segments may result in a singular matrix equation.
- A large radius change between connected segments may decrease accuracy; particularly, with small Δ/a . The problem may be reduced by making the radius change in steps over several segments.

- A segment is required at each point where a network connection or voltage source will be located. This may seem contrary to the idea of an excitation gap as a break in a wire. A continuous wire across the gap is needed, however, so that the required voltage drop can be specified as a boundary condition.
- The two segments on each side of a charge density discontinuity voltage source should be parallel and have the same length and radius. When this source is at the base of a segment connected to a ground plane, the segment should be vertical.
- The number of wires joined at a single junction cannot exceed 30 because of a dimension limitation in the code.
- When wires are parallel and very close together, the segments should be aligned to avoid incorrect current perturbations from offset match points and segment junctions.
- Although extensive tests have not been conducted, it is safe to specify that wires should be several radii apart.

2. SURFACE MODELING

A conducting surface is modeled by means of multiple, small flat surface patches corresponding to the segments used to model wires. The patches are chosen to cover completely the surface to be modeled, conforming as closely as possible to curved surfaces. The parameters defining a surface patch are the Cartesian coordinates of the patch center, the components of the outward-directed, unit normal vector and the patch area. These are illustrated in figure 1 where $\bar{r}_o = x_o \hat{x} + y_o \hat{y} + z_o \hat{z}$ is the position of the segment center; $\hat{n} = n_x \hat{x} + n_y \hat{y} + n_z \hat{z}$ is the unit normal vector and A is the patch area. Although the shape (square, rectangular, etc.) may be used to define a patch on input it does not affect the solution since there is no integration over the patch unless a wire is connected to the patch center. The program computes the surface current on each patch along the orthogonal unit vectors \hat{t}_1 and \hat{t}_2 ,

Figure 1. Patch Position and Orientation.

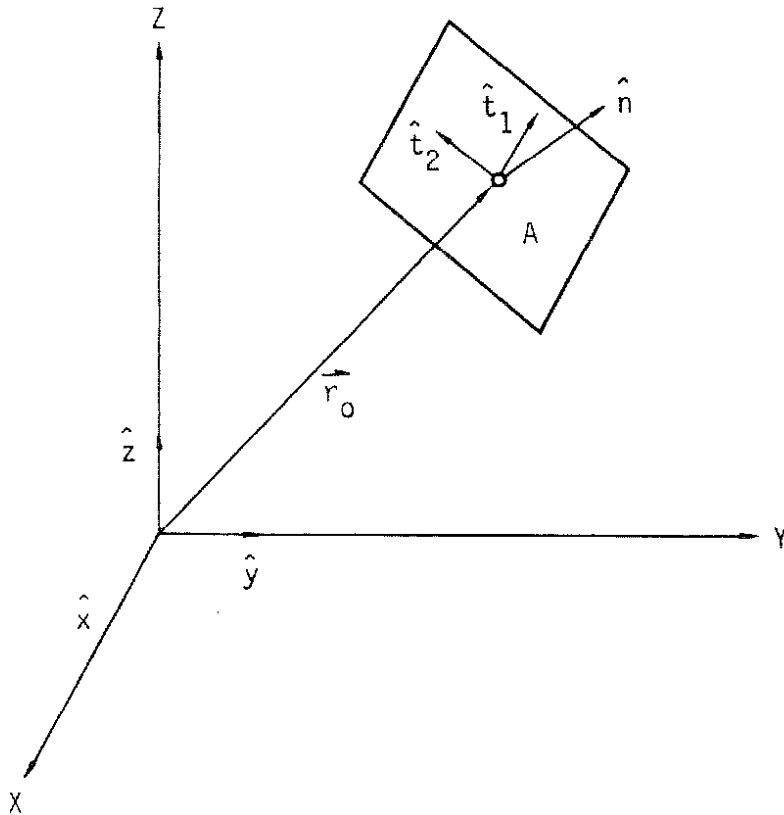

which are tangent to the surface. The vector \hat{t}_1 is parallel to a side of the triangular, rectangular, or quadrilateral patch. For a patch of arbitrary shape, it is chosen by the following rules:

For a horizontal patch,

$$\hat{t}_1 = \hat{x} .$$

For a nonhorizontal patch,

$$\hat{t}_1 = (\hat{z} \times \hat{n}) / |\hat{z} \times \hat{n}| ,$$

\hat{t}_2 is then chosen as $\hat{t}_2 = \hat{n} \times \hat{t}_1$. When a structure having plane symmetry is formed by reflection in a coordinate plane using a GX input card, the vectors \hat{t}_1 , \hat{t}_2 and \hat{n} are also reflected so that the new patches will have $\hat{t}_2 = -\hat{n} \times \hat{t}_1$.

When a wire is connected to a surface, the wire must end at the center of a patch with identical coordinates used for the wire end and the patch center. The program then divides the patch into four equal patches about the wire end as shown in figure 2, where a wire has been connected to the

second of three previously identical patches. The connection patch is divided along lines defined by the vectors \hat{t}_1 and \hat{t}_2 for that patch, with a square patch assumed. The four new patches are ordinary patches like those input by the user, except when the interactions between these patches and the lowest segment on the connected wire are computed. In this case an interpolation function is applied to the four patches to represent the current from the wire onto the surface, and the function is numerically integrated over the patches. Thus, the shape of the patch is significant in this case. The user should try to choose patches so that those with wires connected are approximately square with sides parallel to \hat{t}_1 and \hat{t}_2 . The connected wire is not required to be normal to the patch but cannot lie in the plane of the patch. Only a single wire may connect to a given patch and a segment may have a patch connection on only one of its ends. Also, a wire may never connect to a patch formed by subdividing another patch for a previous connection.

As with wire modeling, patch size measured in wavelengths is very important for accuracy of the results. A minimum of about 25 patches should be used per square wavelength of surface area, with the maximum size for an individual patch about 0.04 square wavelengths. Large patches may be used on large smooth surfaces while smaller patches are needed in areas of small radius of curvature, both for geometrical modeling accuracy and for accuracy of the integral equation solution. In the case of an edge, a precise local representation cannot be included; however, smaller patches in the vicinity of

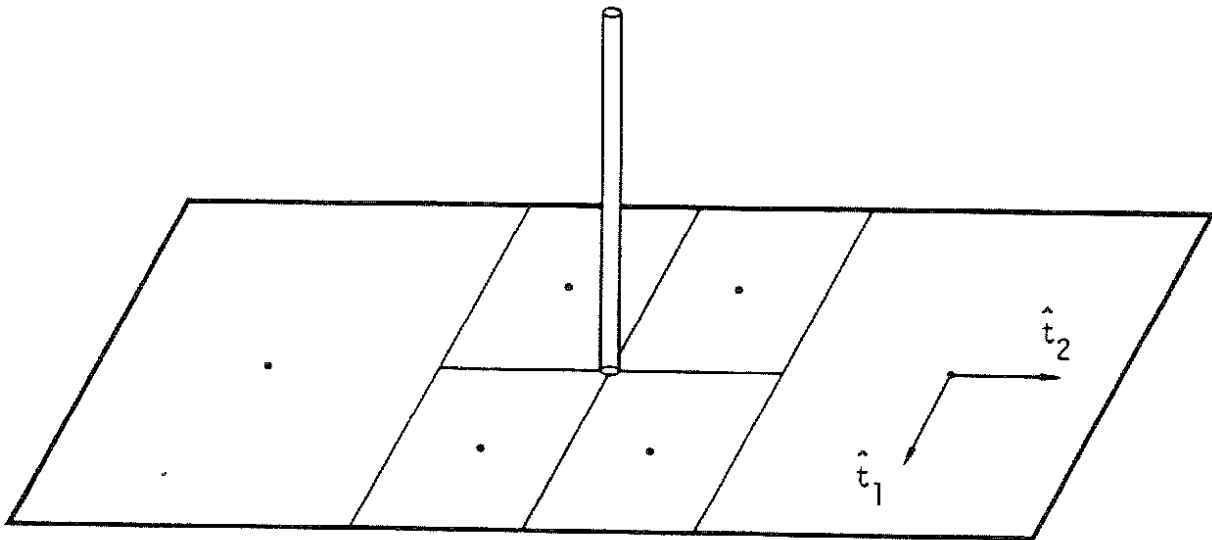
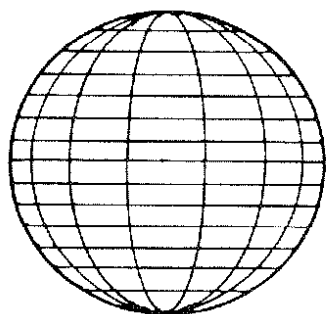

Figure 2. Connection of a Wire to a Surface Patch.

the edge can lead to more accurate results since the current magnitude may vary rapidly in this region. Since connection of a wire to a patch causes the patch to be divided into four smaller patches, a larger patch may be input in anticipation of the subdivision.

While patch shape is not input to the program, very long narrow patches should be avoided when subdividing the surface. This is illustrated by the two methods of modeling a sphere shown in figure 3. The first uses uniform divisions in azimuth and equal cuts along the vertical axis. This results in all patches having equal areas but with long narrow patches near the poles. In the second method, the number of divisions in azimuth is increased toward the equator so that the patch length and width are kept more nearly equal. The areas are again kept approximately equal. The results of the two segmentations are shown in figure 4 for scattering by a sphere of ka ($2\pi \cdot$ radius/wavelength) equal to 5.3. The uniform segmentation used 14 increments in azimuth and 14 equal bands along the vertical axis. The variable segmentation used 13 equal increments in arc length along the vertical axis, with each band from top to bottom divided into the following number of patches in azimuth: 4, 8, 12, 16, 20, 24, 24, 24, 20, 16, 12, 8, 4. Much better agreement with experiment is obtained with the variable segmentation.

In general, the use of surface patches is restricted to modeling voluminous bodies. The surface modeled must be closed since the patches only model the side of the surface from which their normals are directed outward. If a somewhat thin body, such as a box with one narrow dimension, is modeled with patches the narrow sides (edges) must be modeled as well as the broad



Uniform Segmentation

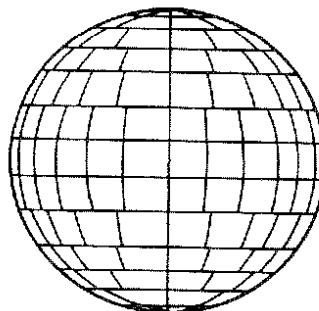

Variable Segmentation

Figure 3. Patch Models for a Sphere.

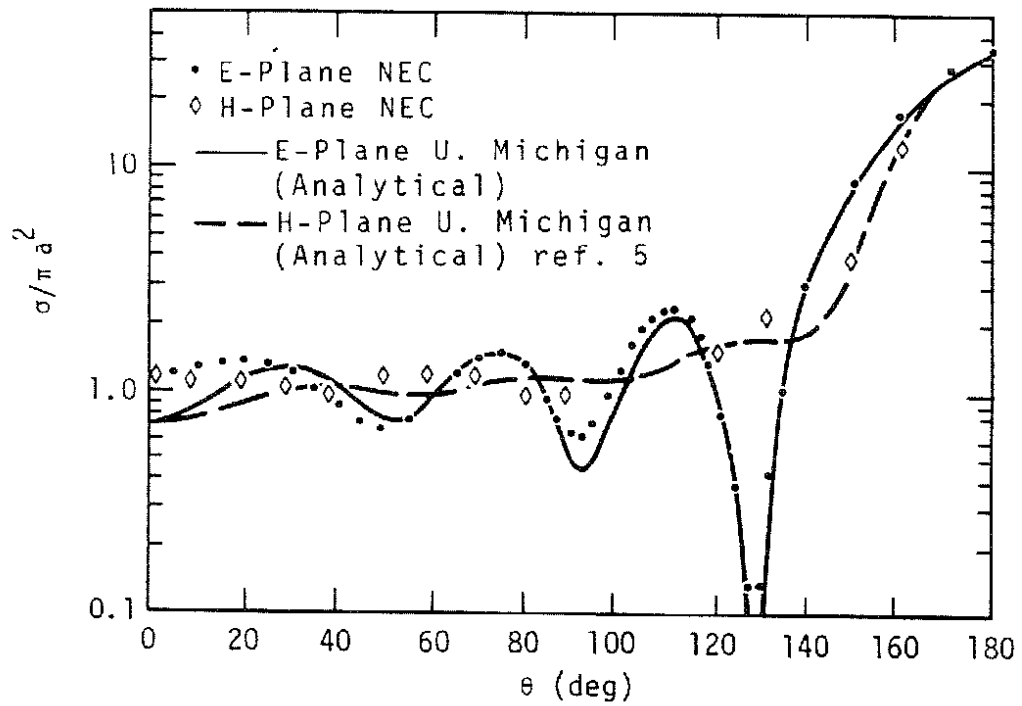

(a) Uniform Segmentation

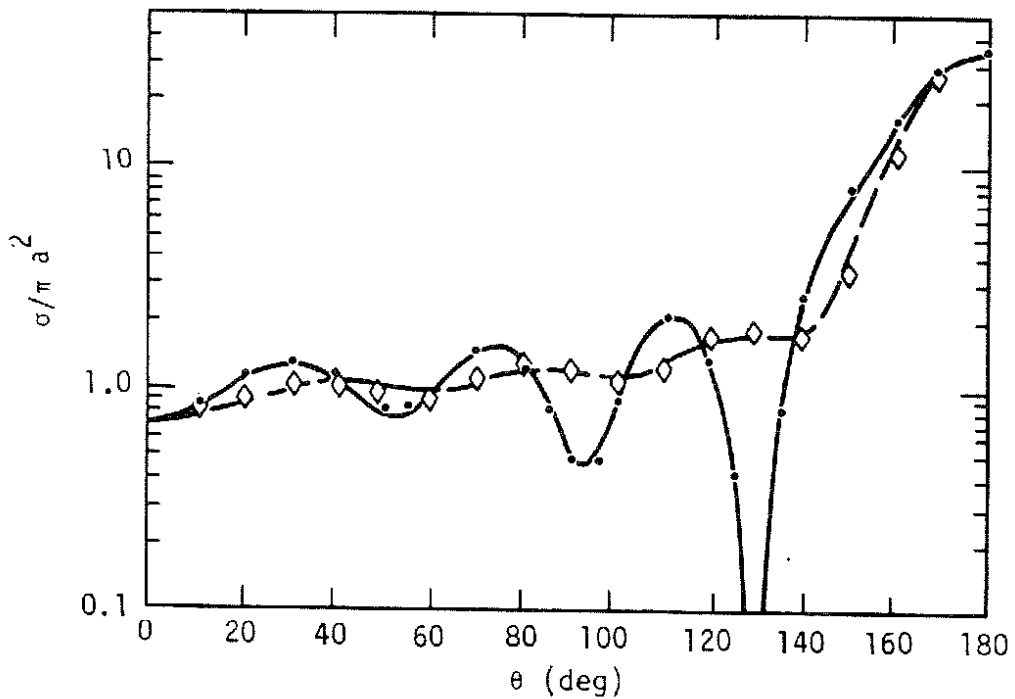

(b) Variable ϕ Segmentation

Figure 4. Bistatic RCS of a Sphere with $ka = 5.3$.

surfaces. Furthermore, the parallel surfaces on opposite sides cannot be too close together or severe numerical error will occur.

When modeling complex structures with features not previously encountered, accuracy may be checked by comparison with reliable experimental data if available. Alternatively, it may be possible to develop an idealized model for which the correct results can be estimated while retaining the critical features of the desired model. The optimum model for a class of structures can be estimated by varying the segment and patch density and observing the effect on the results. Some dependence of results on segmentation will always be found. A large dependence, however, would indicate that the solution has not converged and more segments or patches should be used. A model will generally be useable over a band of frequencies. For frequencies beyond the upper limit of a particular model, a new set of geometry cards must be input with a finer segmentation.

3. MODELING STRUCTURES OVER GROUND

Several options are available in NEC for modeling an antenna over a ground plane. For a perfectly conducting ground, the code generates an image of the structure reflected in the ground surface. The image is exactly equivalent to a perfectly conducting ground and results in solution accuracy comparable to that for a free-space model. Structures may be close to the ground or contacting it in this case. However, for a horizontal wire with radius a , and height h , to the wire axis, $[h^2 + a^2]^{1/2}$ should be greater than about 10^{-6} wavelengths. Furthermore, the height should be at least several times the radius for the thin-wire approximation to be valid. This method doubles the time to fill the interaction matrix.

A finitely conducting ground may be modeled by an image modified by the Fresnel plane-wave reflection coefficients. This method is fast but of limited accuracy and should not be used for structures close to the ground. The reflection coefficient approximation for the near fields can yield reasonable accuracy if the structure is at least several tenths of a wavelength above the ground. It should not be used for structures having a large horizontal extent over the ground such as some traveling-wave antennas.

An alternate method (Sommerfeld/Norton), available for wires only, uses the exact solution for the fields in the presence of ground and is accurate close to the ground. For a horizontal wire the height restriction is the same as for a perfect ground. When this method is used NEC requires an input file

(TAPE21) containing field values for the specific ground parameters and frequency. This interpolation table must be generated by running a separate program, SOMNEC, prior to the NEC run. The present NEC code uses the Sommerfeld/Norton method only for wire-to-wire interactions. If Sommerfeld/Norton is requested for a structure that includes surfaces, the reflection coefficient approximation will be used for surface-to-surface and surface-to-wire interactions. Computation of wire-to-wire interactions by the Sommerfeld/Norton method takes about four times longer than for free space. In addition, computation of the interpolation table requires about 15 s on a CDC 7600 computer. However, the file of interpolation tables may be saved and reused for problems having the same ground parameters and frequency. The Sommerfeld/Norton method is not available in the earlier code NEC-1.

A wire ground screen may be modeled with the Sommerfeld/Norton method if it is raised slightly above the ground surface. A ground stake cannot be modeled in NEC since there is presently no provision to compute interactions across the interface. Wires may end on a ground plane with a condition that the charge density (i.e., derivative of current) be zero at the base of the wire, but this is accurate only for a perfectly conducting ground. A wire may end on a finitely conducting ground with the charge set to zero at the connection, but this will not accurately model a ground stake. If a wire is driven against a finitely conducting ground in this way, the input impedance will typically be dependent on length of the source segment.

NEC also includes options for a radial-wire ground-screen approximation and two-medium ground approximation (cliff) based on modified reflection coefficients. These methods are implemented only for wires and not for patches, however. For the radial-wire ground-screen approximation, an approximate surface impedance - based on the wire density and the ground parameters - is computed at specular reflection points. Since the formula for surface impedance yields zero at the center of the screen, the current on a vertical monopole will be the same as over a perfect ground. The ground screen approximation is used in computing both near-field interactions and the radiated field. It should be noted that defraction from the edge of the screen is not included. When limited accuracy can be accepted, the ground screen approximation provides a large time saving over explicit modeling with the Sommerfeld/Norton method since the ground screen does not increase the number of unknowns in the matrix equation.

The two-medium ground approximation permits the user to define a linear or circular cliff with different ground parameters and ground height on opposite sides. This approximation is not used for the near-field interactions affecting the currents but is used in computing the radiated field. The reflection coefficient is based on the ground parameters and height at the specular-reflection point for each ray. This option may also be used to compute the current over a perfect ground and then compute radiated fields for a finitely conducting ground.

Section III Program Input

Data to describe an antenna and its environment and to request computation of antenna characteristics are input by means of punched cards. The data-card set for a single run consists of three types of data cards. The deck begins with one or more cards containing a description of the run which is printed at the start of the output as a label. These are followed by geometry data cards which specify the geometry of the antenna. Finally, a section of program control cards specifies electrical parameters such as frequency, loading and excitation, and requests calculation of antenna currents and fields.

Every data card has a two-letter alphabetic code in columns one and two to identify the card to the program. All cards having numeric data are punched in a similar format, with integer numbers first followed by real numbers. On antenna geometry data cards, there are two fields for integer numbers (columns 3 through 5 and 6 through 10) followed by real-number fields of ten columns each to the end of the card. The program control cards, following the geometry data, have four integer fields (3 through 5, 6 through 10, 11 through 15, and 16 through 20) followed by real-number fields.

Integer numbers must be punched so that the number ends in the last column of its field. If spaces are left at the end of the field, they will be read as zeros which, in effect, multiplies the desired number by a power of ten. Real numbers are punched as a string of digits containing a decimal, and may be punched anywhere in their field. On the program control cards, following the geometry data, real numbers may also be punched as a string of digits containing a decimal followed by an exponent of ten in the form $E \pm I$, multiplying the number by $10^{\pm I}$. The integer exponent must be between the exponent limits of the computer. When an exponent is used, the integer must end in the last column of the field. Otherwise, spaces will be read as zeros, which is the same as multiplying the exponent by a power of ten. If the field on the card is left blank, the number will be read as zero for either integer or real numbers.

1. COMMENT CARDS

The data-card deck for a run must begin with one or more comment cards which can contain a brief description and structure parameters for the run. The cards are printed at the beginning of the output of the run for identification only and have no effect on the computation. Any alphabetic and numeric characters can be punched on these cards. The comment cards, like all other data cards, have a two-letter identifier in columns 1 and 2. The two forms for comment cards are:

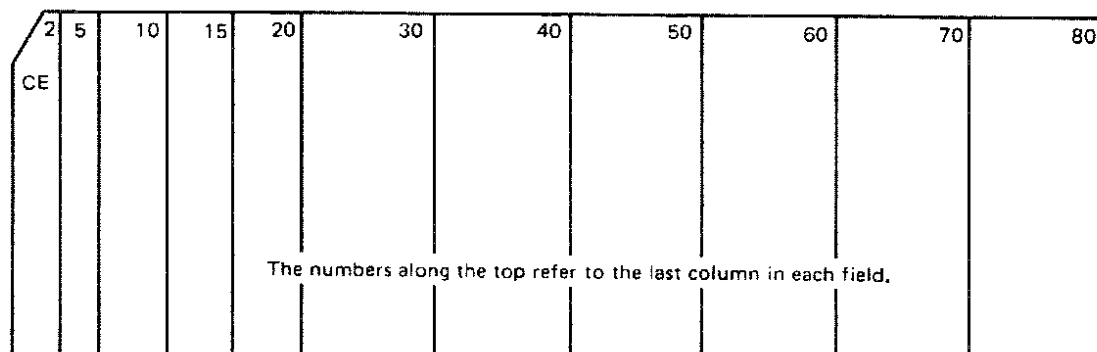
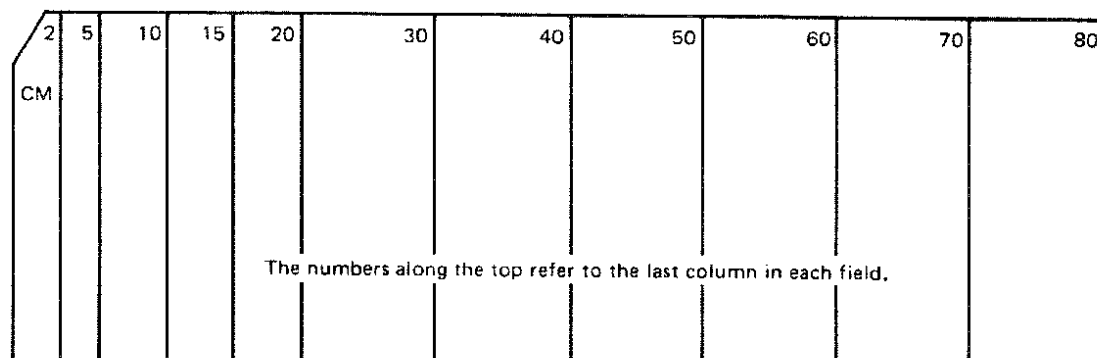

When a CM card is read, the contents of columns 3 through 80 is printed in the output, and the next card is read as a comment card. When a CE card is read, columns 3 through 80 are printed, and reading of comments is terminated. The next card must be a geometry card. Thus, a CE card must always occur in a data deck and may be preceded by as many CM cards as are needed to describe the run.

2. STRUCTURE GEOMETRY INPUT

For convenient input of structure geometry data, several data-card options are provided to generate data for groups of segments or patches. The segment data for a straight wire with an arbitrary number of segments may be generated by a single input card specifying the Cartesian coordinates of each end of the wire and the number of segments. Other input cards can cause a structure to be reflected in a coordinate plane or rotated about an axis to complete the structure.

The geometry input also permits the user to assign tag numbers to the segments for later use in referring to a segment; for example, to specify the location of a voltage source. Each segment has an absolute segment number associated with it which is determined by its location in the sequence of segments specified by the input data. This number can be used to refer to a particular segment. The absolute segment number of the segment in a given location may be difficult to determine in advance, however, when the structure is large and complex. In such cases the segment may be more easily referenced if it is assigned a tag number. The input card for wires includes a provision for specifying a tag number which is assigned to all segments of that wire. A segment can then be identified by its tag number and its number in the set of segments having that same tag number. Thus, if a wire is specified in some part of a structure with 7 segments and a tag of 3, then the center segment of the wire could be referred to as tag 3, segment 4.

The geometry data cards are:

GA - wire arc specification

GE - end geometry data

GF - use Numerical Green's Function

GM - shift and duplicate structure

GR - generate cylindrical structure (symmetry)

GS - scale structure dimensions

GW - specify wire (also GC)

GX - reflect structure (symmetry)

SP - specify surface patch (also SC)

SM - generate multiple surfaces patches (also SC)

The GE card is required to signal the end of the geometry data. The other cards may be used as needed to generate the required structure.

The format for segment geometry data cards begins with a two letter identifier in columns 1 and 2. Two fields for integer numbers follow in columns 3 through 5 and 6 through 10. These are followed by real-number fields in columns 11 through 20, 21 through 30, and continuing in fields of 10 columns to the end of the card. Not all of these number fields are used on most cards, however. In the following descriptions of cards, the integer numbers are referred to as I1 and I2, and the decimal numbers as F1, ..., F7. The Fortran variable names of the parameters on each card are also given in cases where they serve as useful mnemonics.

Wire Arc Specification (GA)

Purpose: To generate a circular arc of wire segments.

Card:

2	5	10	20	30	40	50	60	70	80
GA	I1	I2	F1	F2	F3	F4	blank	blank	blank
	ITG	NS	RADA	ANG1	ANG2	RAD			

The numbers along the top refer to the last column in each field.

Parameters:

Integers

ITG (I-1) - Tag number assigned to all segments of the wire arc.

NS (I-2) - Number of segments into which the arc will be divided.

E.G. 4 (MAKES A SQUARE)

Decimal Numbers

RADA (F1) - Arc radius (center is the origin and the axis is the y axis).

ANG1 (F2) - Angle of first end of the arc measured from the x axis in a left-hand direction about the y axis (degrees).

ANG2 (F3) - Angle of the second end of the arc.

RAD (F4) - Wire radius.

Notes:

- The segments generated by GA form a section of polygon inscribed within the arc.
- If an arc in a different position or orientation is desired the segments may be moved with a GM card.
- Use of GA to form a circle will not result in symmetry being used in the calculation. It is a good way to form the beginning of the circle, to be completed by GR, however.
- (See notes for GW)

End Geometry Input (GE)

Purpose: To terminate reading of geometry data cards and reset geometry data if a ground plane is used.

Card:

	2	5	10	20	30	40	50	60	70	80
	GE	11	blank	blank	blank	blank	blank	blank	blank	blank
The numbers along the top refer to the last column in each field.										

Parameters:

Integers

(11) - Geometry ground plane flag. The values are:

0 - no ground plane is present.

1 - indicates a ground plane is present. Structure symmetry is modified as required, and the current expansion is modified so that the currents on segments touching the ground (X, Y plane) are interpolated to their images below the ground (charge at base is zero).

-1 - indicates a ground is present. Structure symmetry is modified as required. Current expansion, however, is not modified. Thus, currents on segments touching the ground will go to zero at the ground.

Decimal Numbers

The decimal number fields are not used.

Notes:

- The basic function of the GE card is to terminate reading of geometry data cards. In doing this, it causes the program to search through the segment data that have been generated by the preceding cards to determine which wires are connected for current expansion.
- At the time that the GE card is read, the structure dimensions must be in units of meters.

- A positive or negative value of I1 does not cause a ground to be included in the calculation. It only modifies the geometry data as required when a ground is present. The ground parameters must be specified on a program control card following the geometry cards.
- When I1 is nonzero, no segment may extend below the ground plane (X,Y plane) or lie in this plane. Segments may end on the ground plane, however.
- If the height of a horizontal wire is less than 10^{-3} times the segment length, I1 equal to 1 will connect the end of every segment in the wire to ground. I1 should then be -1 to avoid this disaster.
- As an example of how the symmetry of a structure is affected by the presence of a ground plane (X, Y plane), consider a structure generated with cylindrical symmetry about the Z axis. The presence of a ground does not affect the cylindrical symmetry. If however this same structure is rotated off the vertical, the cylindrical symmetry is lost in the presence of the ground. As a second example, consider a dipole parallel to Z axis which was generated with symmetry about its feed. The presence of a ground plane destroys this symmetry. The program modifies structure symmetries as follows when I1 is nonzero. If the structure was rotated about the X or Y axis by the GM card, all symmetry is lost (i.e., the no-symmetry condition is set). If the structure was not rotated about the X or Y axis, only symmetry about a plane parallel to the X, Y plane is lost. Translation of a structure does not affect symmetries.

Read NGF File (GF)

Purpose: To read a previously written NGF file.

Card:

2	5	10	20	30	40	50	60	70	80
GF	11	blank	blank	blank	blank	blank	blank	blank	blank
The numbers along the top refer to the last column in each field.									

Parameters:

Integers

(11) - Print a table of the coordinates of the ends of all segments in the NGF if 11 \neq 0. Normal printing otherwise.

Notes:

- GF must be the first card in the structure geometry section, immediately after CE.
- The effects of some other data cards are altered when a GF card is used. See section III-5.

Coordinate Transformation (GM)

Purpose: To translate or rotate a structure with respect to the coordinate system or to generate new structures translated or rotated from the original.

Card:

2	5	10	20	30	40	50	60	70	80
GM	I1	I2	F1	F2	F3	F4	F5	F6	F7
	ITGI	NRPT	ROX	ROY	ROZ	XS	YS	ZS	ITS
The numbers along the top refer to the last column in each field.									

Parameters:

Integers

- ITGI (I1) - Tag number increment.
 NRPT (I2) - The number of new structures to be generated.

Decimal Numbers

- ROX (F1) - Angle in degrees through which the structure is rotated about the X-axis. A positive angle causes a right-hand rotation.
 ROY (F2) - Angle of rotation about Y-axis.
 ROZ (F3) - Angle of rotation about Z-axis.
 XS (F4) - } X, Y, Z components of vector by which
 YS (F5) - } structure is translated with respect to
 ZS (F6) - } the coordinate system.
 ITS (F7) - This number is input as a decimal number but is rounded to an integer before use. Tag numbers are searched sequentially until a segment having a tag of ITS is found. The part of the structure composed of this segment through the end of the sequence of segments is moved by the card. If ITS is blank (usual case) or zero the entire structure is moved.

Notes:

- If NRPT is zero, the structure is moved by the specified rotation and translation leaving nothing in the original location. If NRPT is greater than zero, the original structure remains fixed and NRPT new structures are formed, each shifted from the previous one by the requested transformation.
- The tag increment, ITGI, is used when new structures are generated (NRPT greater than zero) to avoid duplication of tag numbers. Tag numbers of the segments in each new copy of the structure are incremented by ITGI from the tags on the previous copy or original. Tags of segments which are generated from segments having no tags (tag equal to zero) are not incremented. Generally, ITGI will be greater than or equal to the largest tag number used on the original structure to avoid duplication of tags. For example, if tag numbers 1 through 100 have been used before a (GM) card is read having NRPT equal to 2, then ITGI equal to 100 will cause the first copy of the structure to have tags from 101 to 200 and the second copy from 201 to 300. If NRPT is zero, the tags on the original structure will be incremented.
- The result of a transformation depends on the order in which the rotations and translation are applied. The order used is first rotation about X-axis, then rotation about the Y-axis, then rotation about the Z-axis and, finally, translation by (XS, YS, ZS). All operations refer to the fixed coordinate system axes. If a different order is desired, separate GM cards may be used.

Generate Cylindrical Structure (GR)

Purpose: To reproduce a structure while rotating about the Z-axis to form a complete cylindrical array and to set flags so that symmetry is utilized in the solution.

Card:

2	5	10	20	30	40	50	60	70	80
GR	11	12	blank	blank	blank	blank	blank	blank	blank

The numbers along the top refer to the last column in each field.

Parameters:

Integers

- (I1) - Tag number increment.
- (I2) - Total number of times that the structure is to occur in the cylindrical array.

Decimal Numbers

The decimal number fields are not used.

Notes:

- The tag increment (I1) is used to avoid duplication of tag numbers in the reproduced structures. In forming a new structure for the array, all valid tags on the previous copy or original structure are incremented by (I1). Tags equal to zero are not incremented.
- The GR card should never be used when there are segments on the Z-axis or crossing the Z-axis since overlapping segments would result.
- The GR card sets flags so the program makes use of cylindrical symmetry in solving for the currents. If a structure modeled by N segments has M sections in cylindrical symmetry (formed by a GR card with I2 equal to M), the number of complex numbers in matrix storage

and the proportionality factors for matrix fill time and matrix factor time are:

	<u>Matrix Storage</u>	<u>Fill Time</u>	<u>Factor Time</u>
No Symmetry	N^2	N^2	N^3
M Symmetric Sections	N^2/M	N^2/M	N^3/M^2

The matrix factor time represents the optimum for a large matrix factored in core. Generally, somewhat longer times will be observed.

- If the structure is added to or modified after the GR card in such a way that cylindrical symmetry is destroyed, the program must be reset to a no-symmetry condition. In most cases, the program is set by the geometry routines for the existing symmetry. Operations that automatically reset the symmetry conditions are:

Addition of a wire by a GW card destroys all symmetry.

Generation of additional structures by a GM card, with NRPT greater than zero, destroys all symmetry.

A GM card acting on only part of the structure (having ITS greater than zero) destroys all symmetry.

A GX or GR card will destroy all previously established symmetry.

If a structure is rotated about either the X or Y axis by use of a GM card and a ground plane is specified on the GE card, all symmetry will be destroyed. Rotation about the Z-axis or translation will not affect symmetry. If a ground is not specified, symmetry will be unaffected by any rotation or translation by a GM card, unless NRPT or ITS on the GM card is greater than zero.

- Symmetry will also be destroyed if lumped loads are placed on the structure in an unsymmetric manner. In this case, the program is not automatically set to a no-symmetry condition but must be set by a data card following the GR card. A GW card with NS blank will set the program to a no-symmetry condition without modifying the structure. The card must specify a nonzero radius, however, to avoid reading a GC card.
- Placement of nonradiating networks or sources does not affect symmetry.

- When symmetry is used in the solution, the number of symmetric sections (I2) is limited by array dimensions. In the demonstration deck, the limit is 16 sections.
- The GR card produces the same effect on the structure as a GM card if I2 on the GR card is equal to (NRPT+1) on the GM card and if ROZ on the GM card is equal to $360/(NRPT+1)$ degrees. If the GM card is used, however, the program will not be set to take advantage of symmetry.

Scale Structure Dimensions (GS)

Purpose: To scale all dimensions of a structure by a constant.

Card:

	2	5	10	20	30	40	50	60	70	80
GS	blank	blank	F1	blank	blank	blank	blank	blank	blank	blank
The numbers along the top refer to the last column in each field.										

Parameters:

Integers

The integer fields are not used.

Decimal Numbers

(F1) - All structure dimensions, including wire radius, are multiplied by F1.

Notes:

- At the end of geometry input, structure dimensions must be in units of meters. Hence, if the dimensions have been input in other units, a GS card must be used to convert to meters.

Wire Specification (GW)

Purpose: To generate a string of segments to represent a straight wire.

Card:

2	5	10	20	30	40	50	60	70	80
GW	I1	I2	F1	F2	F3	F4	F5	F6	F7
	ITG	NS	XW1	YW1	ZW1	XW2	YW2	ZW2	RAD

The numbers along the top refer to the last column in each field.

The above card defines a string of segments with radius RAD. If RAD is zero or blank, a second card is read to set parameters to taper the segment lengths and radius from one end of the wire to the other. The format for the second card (GC), which is read only when RAD is zero, is:

2	5	10	20	30	40	50	60	70	80
GC	blank	blank	F1	F2	F3	blank	blank	blank	blank
			RDEL	RAD1	RAD2				

The numbers along the top refer to the last column in each field.

Parameters:

Integers

- ITG (I1) - Tag number assigned to all segments of the wire.
- NS (I2) - Number of segments into which the wire will be divided.

Decimal Numbers

- | | | | |
|-----|---------------------|---|---------------|
| XW1 | (F1) - X coordinate | } | of wire end 1 |
| YW1 | (F2) - Y coordinate | | |
| ZW1 | (F3) - Z coordinate | | |
| XW2 | (F4) - X coordinate | } | of wire end 2 |
| YW2 | (F5) - Y coordinate | | |
| ZW2 | (F6) - Z coordinate | | |

RAD (F7) - Wire radius, or zero for tapered segment option.

Optional GC card parameters

RDEL (F1) - Ratio of the length of a segment to the length of the previous segment in the string.

RAD1 (F2) - Radius of the first segment in the string.

RAD2 (F3) - Radius of the last segment in the string.

The ratio of the radii of adjacent segments is

$$RRAD = \left(\frac{RAD2}{RAD1} \right)^{1/(NS-1)}$$

If the total wire length is L, the length of the first segment is

$$S_1 = \frac{L(1-RDEL)}{1-(RDEL)^{NS}}$$

or

$$S_1 = L/NS \text{ if } RDEL = 1.$$

Notes:

- The tag number is for later use when a segment must be identified, such as when connecting a voltage source or lumped load to the segment. Any number except zero can be used as a tag. When identifying a segment by its tag, the tag number and the number of the segment in the set of segments having that tag are given. Thus, the tag of a segment does not need to be unique. If no need is anticipated to refer back to any segments on a wire by tag, the tag field may be left blank. This results in a tag of zero which cannot be referenced as a valid tag.
- If two wires are electrically connected at their ends, the identical coordinates should be used for the connected ends to ensure that the wires are treated as connected for current interpolation. If wires intersect away from their ends, the point of intersection must occur at segment ends within each wire for interpolation to occur. Generally, wires should intersect only at their ends unless the location of segment ends is accurately known.
- The only significance of differentiating end one from end two of a wire is that the positive reference direction for current will be in the direction from end one to end two on each segment making up the wire.

- As a rule of thumb, segment lengths should be less than 0.1 wavelength at the desired frequency. Somewhat longer segments may be used on long wires with no abrupt changes, while shorter segments, 0.05 wavelength or less, may be required in modeling critical regions of an antenna.
- If input is in units other than meters, then the units must be scaled to meters through the use of a Scale Structure Dimensions (GS) card.

Reflection in Coordinate Planes (GX)

Purpose: To form structures having planes of symmetry by reflecting part of the structure in the coordinate planes, and to set flags so that symmetry is utilized in the solution.

Card:

2	5	10	20	30	40	50	60	70	80
GX	I1	I2	blank	blank	blank	blank	blank	blank	blank
The numbers along the top refer to the last column in each field.									

Parameters:

Integers

- (I1) — Tag number increment.
- (I2) — This integer is divided into three independent digits, in columns 8, 9, and 10 of the card, which control reflection in the three orthogonal coordinate planes. A one in column 8 causes reflection along the X-axis (reflection in Y, Z plane); a one in column 9 causes reflection along the Y-axis; and a one in column 10 causes reflection along the Z axis. A zero or blank in any of these columns causes the corresponding reflection to be skipped.

Decimal Numbers

The decimal number fields are not used.

Notes:

- Any combination of reflections along the X, Y and Z axes may be used. For example, 101 for (I2) will cause reflection along axes X and Z, and 111 will cause reflection along axes X, Y and Z. When combinations of reflections are requested, the reflections are done in reverse alphabetical order. That is, if a structure is generated in a single octant of space and a GX card is then read with I2 equal to 111, the structure is first reflected along the Z-axis; the structure and its image are then reflected along the Y-axis; and,

finally, these four structures are reflected along the X-axis to fill all octants. This order determines the position of a segment in the sequence and, hence, the absolute segment numbers.

- The tag increment I1 is used to avoid duplication of tag numbers in the image segments. All valid tags on the original structure are incremented by I1 on the image. When combinations of reflections are employed, the tag increment is doubled after each reflection. Thus, a tag increment greater than or equal to the largest tag on the original structure will ensure that no duplicate tags are generated. For example, if tags from 1 to 100 are used on the original structure with I2 equal to 011 and a tag increment of 100, the first reflection, along the Z-axis, will produce tags from 101 to 200; and the second reflection, along the Y-axis, will produce tags from 201 to 400, as a result of the increment being doubled to 200.
- The GX card should never be used when there are segments located in the plane about which reflection would take place or crossing this plane. The image segments would then coincide with or intersect the original segments, and such overlapping segments are not allowed. Segments may end on the image plane, however.
- When a structure having plane symmetry is formed by a GX card, the program will make use of the symmetry to simplify solution for the currents. The number of complex numbers in matrix storage and the proportionality factors for matrix fill time and matrix factor time for a structure modeled by N segments are:

<u>No. of Planes of Symmetry</u>	<u>Matrix Storage</u>	<u>Fill Time</u>	<u>Factor Time</u>
0	N^2	N^2	N^3
1	$\frac{N^2}{2}$	$\frac{N^2}{2}$	$\frac{N^3}{4}$
2	$\frac{N^2}{4}$	$\frac{N^2}{4}$	$\frac{N^3}{16}$
3	$\frac{N^2}{8}$	$\frac{N^2}{8}$	$\frac{N^3}{64}$

The matrix factor time represents the optimum for a large matrix factored in core. Generally, somewhat longer times will be observed.

- If the structure is added to or modified after the GX card in such a way that symmetry is destroyed, the program must be reset to a no-symmetry condition. In most cases, the program is set by the geometry routines for the existing symmetry. Operations that automatically reset the symmetry condition are:

Addition of a wire by a GW card destroys all symmetry.

Generation of additional structures by a GM card, with NRPT greater than zero, destroys all symmetry.

A GM card acting on only part of the structure (having ITS greater than zero) destroys all symmetry.

A GX card or GR card will destroy all previously established symmetry. For example, two GR cards with I2 equal to 011 and 100, respectively, will produce the same structure as a single GX card with I2 equal to 111; however, the first case will set the program to use symmetry about the Y, Z plane only while the second case will make use of symmetry about all three coordinate planes.

If a ground plane is specified on the GE card, symmetry about a plane parallel to the X, Y plane will be destroyed. Symmetry about other planes will be used, however.

If a structure is rotated about either the X or Y axis by use of a GM card and a ground plane is specified on the GE card, all symmetry will be destroyed. Rotation about the Z-axis or translation will not affect symmetry. If a ground is not specified, no rotation or translation will affect symmetry conditions unless NRPT on the GM card is greater than zero.

Symmetry will also be destroyed if lumped loads are placed on the structure in an unsymmetric manner. In this case, the program is not automatically set to a no-symmetry condition but must be set by a data card following the GX card. A GW card with NS blank will set the program to a no-symmetry condition without modifying the structure. The card must specify a nonzero radius, however, to avoid reading a GC card.

- Placement of sources or nonradiating networks does not affect symmetry.

Surface Patch (SP)

Purpose: To input parameters of a single surface patch.

Card:

2	5	10	20	30	40	50	60	70	80
SP	I1 blank	I2 NS	F1 X1	F2 Y1	F3 Z1	F4 X2	F5 Y2	F6 Z2	blank
The numbers along the top refer to the last column in each field.									

If NS is 1, 2, or 3, a second card is read in the following format:

2	5	10	20	30	40	50	60	70	80
SC	I1 blank	I2	F1 X3	F2 Y3	F3 Z3	F4 X4	F5 Y4	F6 Z4	blank
The numbers along the top refer to the last column in each field.									

Parameters:Integers

(I1) — not used

NS (I2) — Selects patch shape

0: (default) arbitrary patch shape

1: rectangular patch

2: triangular patch

3: quadrilateral patch

Decimal Numbers

Arbitrary shape (NS = 0)

X1	(F1) — X coordinate	}	of patch center
Y1	(F2) — Y coordinate		
Z1	(F3) — Z coordinate		
X2	(F4) — elevation angle above the X-Y plane	}	of outward normal vector (degrees)
Y2	(F5) — azimuth angle from X-axis		
Z2	(F6) — patch area (square of units used)		

Rectangular, triangular, or quadrilateral patch (NS = 1, 2, or 3)

X1	(F1)	}	X, Y, Z coordinates of corner 1
Y1	(F2)		
Z1	(F3)		
X2	(F4)	}	X, Y, Z coordinates of corner 2
Y2	(F5)		
Z2	(F6)		
X3	(F1)	}	X, Y, Z coordinates of corner 3
Y3	(F2)		
Z3	(F3)		

For the quadrilateral patch only (NS = 3)

X4	(F4)	}	X, Y, Z coordinates of corner 4
Y4	(F5)		
Z4	(F6)		

Notes:

- The four patch options are shown in figure 5. For the rectangular, triangular, and quadrilateral patches the outward normal vector \hat{n} is specified by the ordering of corners 1, 2, and 3 and the right-hand rule.
- For a rectangular, triangular, or quadrilateral patch, \hat{e}_1 is parallel to the side from corner 1 to corner 2. For NS = 0, \hat{e}_1 is chosen as described in section II-2.
- If the sides from corner 1 to corner 2 and from corner 2 to corner 3 of the rectangular patch are not perpendicular, the result will be a parallelogram.

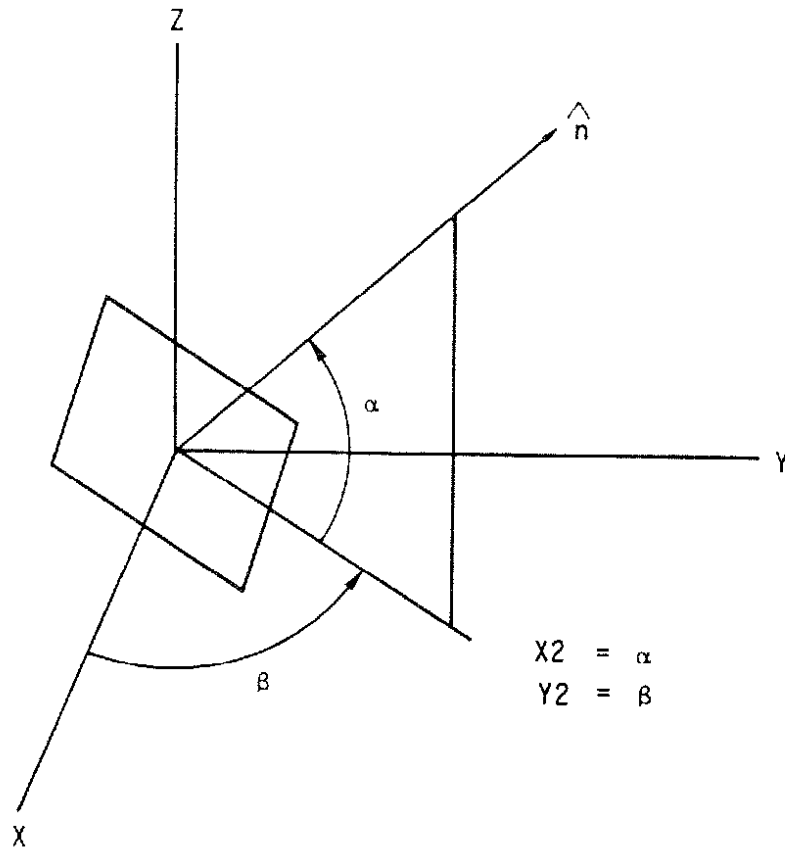

(a) Arbitrary Patch Shape (NS = 0)

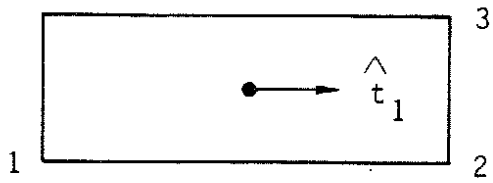

(b) Rectangular Patch (NS = 1)

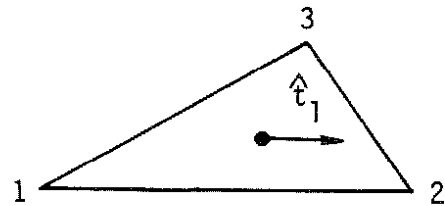

(c) Triangular Patch (NS = 2)

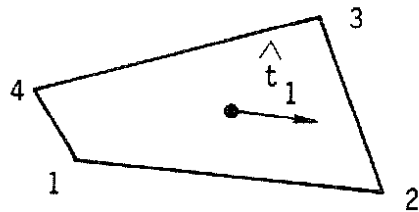

(d) Quadrilateral Patch (NS = 3)

Figure 5. Surface Patch Options.

- If the four corners of the quadrilateral patch do not lie in the same plane, the run will terminate with an error message.
- Since the program does not integrate over patches, except at a wire connection, the patch shape does not affect the results. The only parameters affecting the results are the location of the patch centroid, the patch area, and the outward unit normal vector. For the arbitrary patch shape these are input, while for the other options they are determined from the specified shape. For solution accuracy, however, the distribution of patch centers obtained with generally square patches has been found to be desirable (see section II-2).
- For the rectangular or quadrilateral options, multiple SC cards may follow a SP card to specify a string of patches. The parameters on the second or subsequent SC card specify corner 3 for a rectangle or corners 3 and 4 for a quadrilateral, while corners 3 and 4 of the previous patch become corners 2 and 1, respectively, of the new patch. The integer I2 on the second or subsequent SC card specifies the new patch shape and must be 1 for rectangular shape or 3 for quadrilateral shape. On the first SC card after SP, I2 has no effect. Rectangular or quadrilateral patches may be intermixed, but triangular or arbitrary shapes are not allowed in a string of linked patches.

Multiple Patch Surface (SM)

Purpose: To cover a rectangular region with surface patches.

Card:

2	5	10	20	30	40	50	60	70	80
SM	I1	I2	F1	F2	F3	F4	F5	F6	blank
	NX	NY	X1	Y1	Z1	X2	Y2	Z2	
The numbers along the top refer to the last column in each field.									

A second card with the following format must immediately follow a SM card:

2	5	10	20	30	40	50	60	70	80
SC	blank	blank	F1	F2	F3	F4	F5	F6	blank
			X3	Y3	Z3				
The numbers along the top refer to the last column in each field.									

Parameters:

Integers

NX (I1) } The rectangular surface is divided into NX patches
 NY (I2) } from corner 1 to corner 2 and NY patches from
 corner 2 to corner 3.

Decimal Numbers

X1 (F1) }
 Y1 (F2) } X, Y, Z coordinates of corner 1
 Z1 (F3) }
 X2 (F4) }
 Y2 (F5) } X, Y, Z coordinates of corner 2
 Z2 (F6) }

$$\left. \begin{array}{ll} X3 & (F7) \\ Y3 & (F8) \\ Z3 & (F9) \end{array} \right\} \text{X, Y, Z coordinates of corner 3}$$

Notes:

- The division of the rectangle into patches is as illustrated in figure 6.

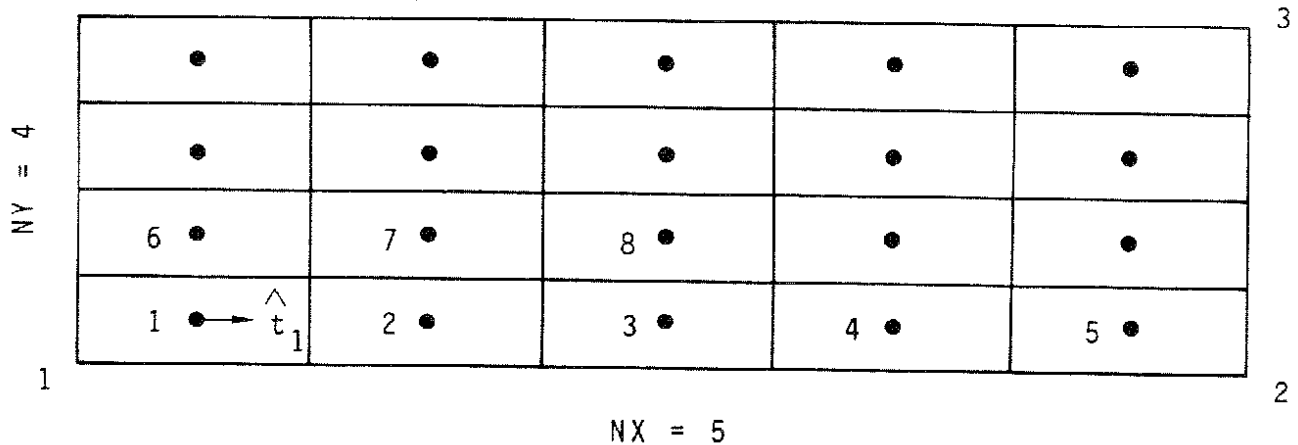

Figure 6. Rectangular Surface Covered by Multiple Patches.

- The direction of the outward normals \hat{n} of the patches is determined by the ordering of corners 1, 2, and 3 and the right-hand rule. The vectors \hat{t}_1 are parallel to the side from corner 1 to corner 2 and $\hat{t}_2 = \hat{n} \times \hat{t}_1$. The patch may have arbitrary orientation.
- If the sides between corners 1 and 2 and between corners 2 and 3 are not perpendicular, the complete surface and the individual patches will be parallelograms.
- Multiple SC cards are not allowed with SM.

Examples of Structure Geometry Data

Rhombic Antenna - No Symmetry

Structure: figure 7

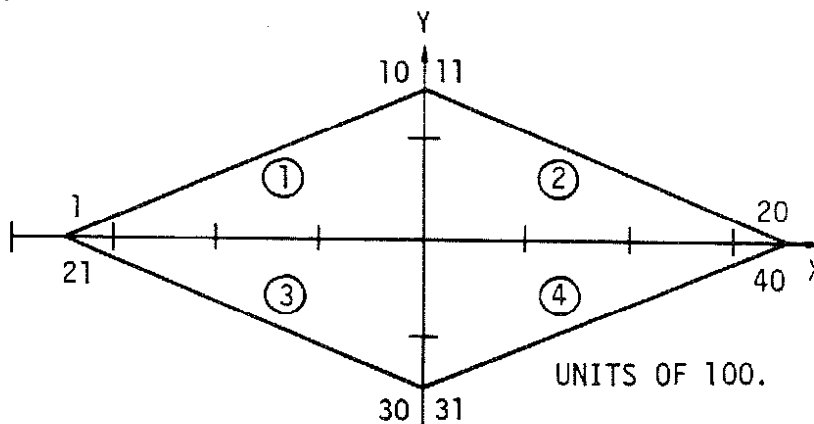

Figure 7. Rhombic Antenna - No Symmetry.

Geometry Data Cards:

	2	5	10	20	30	40	50	60	70	80
GW	1	10	-350.	0.	150.	0.	150.	150.	150.	.1
GW	2	10	0.	150.	150.	350.	0.	150.	150.	.1
GW	3	10	-350.	0.	150.	0.	-150.	150.	150.	.1
GW	4	10	0.	-150.	150.	350.	0.	150.	150.	.1
OS			0. 30*80							.1
GE										

Number of Segments: 40

Symmetry: None

These cards generate segment data for a rhombic antenna. The data are input in dimensions of feet and scaled to meters. In the figure, numbers near the structure represent segment numbers and circled numbers represent tag numbers.

Rhombic Antenna - Plane Symmetry

Structure: figure 8

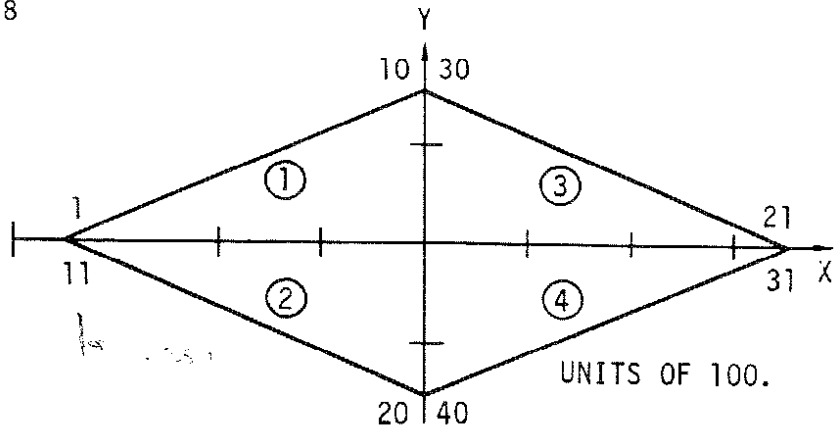

Figure 8. Rhombic Antenna - 2 Planes of Symmetry.

Geometry Data Cards:

2	5	10	20	30	40	50	60	70	80
GW	1	10	-350.	c.	150.	0.	150.	150.	.1
GX	1	110							
GS			0.30480						
GF									

Number of Segments: 40

Symmetry: Two planes

These cards generate the same structure as the previous set although the segment numbering is altered. By making use of two planes of symmetry, these data will require storage of only a 10 by 40 interaction matrix. If segments 21 and 31 are to be loaded as the termination of the antenna, then symmetry about the YZ plane cannot be used. The following cards will result in symmetry about only the XZ plane being used in the solution; thus, allowing segments on one end of the antenna to be loaded.

Structure: figure 9

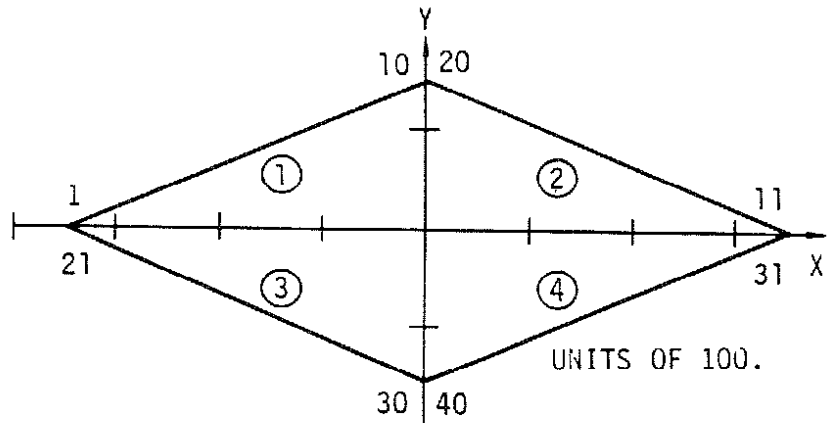

Figure 9. Rhombic Antenna - 1 Plane of Symmetry.

Geometry Data Cards:

	2	5	10	20	30	40	50	60	70	80
GW	1	10	-350.	0.	150.	0.	150.	150.	150.	150.
GX	1	100								
GX	2	010								
GS			0.30480							
GE										

Number of Segments: 40

Symmetry: One plane

Segments 1 through 20 of this structure are in the first symmetric section. Hence, segments 11 and 31 can be loaded without loading segments 1 and 21 (loading segments in symmetric structures is discussed in the section covering the LD card). These data will cause storage of a 20 by 40 interaction matrix.

Two Coaxial Rings

Structure: figure 10

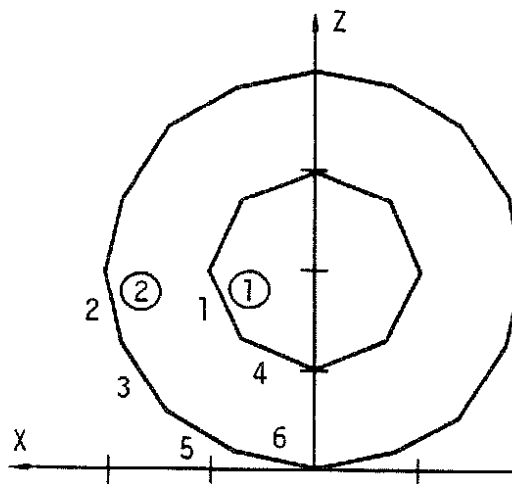

Figure 10. Coaxial Rings.

Geometry Data Cards:

	2	5	10	20	30	40	50	60	70	80
GW	1	1	1.0	0.	0.	0.	0.70711	0.70711	0.	.001
GW	2	1	2.0	0.	0.	0.	0.76536	1.84776	0.	.001
GW	2	1	0.76536	1.84776	0.	0.	1.41421	1.41421	0.	.001
GR		8								
GM			90.	0.	0.	0.	0.	0.	2.0	
GE										

Number of Segments: 24

Symmetry: 8 section cylindrical symmetry

The first 45 degree section of the two rings is generated by the first three GW cards. This section is then rotated about the Z-axis to complete the structure. The rings are then rotated about the X-axis and elevated to produce the structure shown. Since no tag increment is specified on the GR card, all segments on the first ring have tags of 1 and all segments on the second ring have tags of 2. Because of symmetry, these data will require storage of only a 3 by 24 interaction matrix. If a 1 were punched in column 5 of the GE card, however, symmetry would be destroyed by the interaction with the ground, requiring storage of a 24 by 24 matrix.

Linear Antenna over a Wire Grid Plate

Structure: figure 11

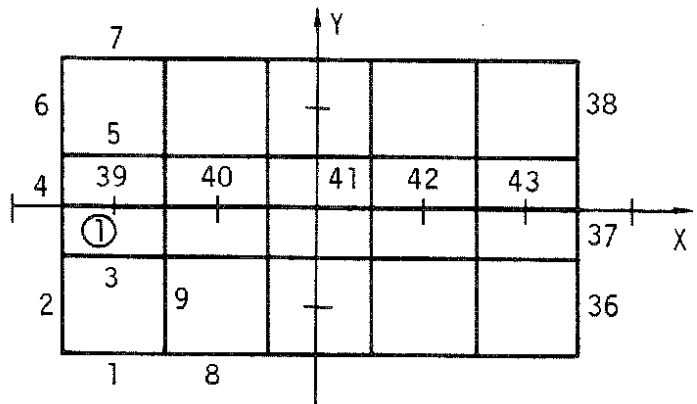

Figure 11. Wire Grid Plate and Dipole.

Geometry Data Cards:

2	5	10	20	30	40	50	60	70	80
GM		1	0.	0.	0	0.1	0.	0.	.001
GM		1	0.	0.	0.	0.	0.1	0.	.001
GM		2	0.	0.	0.	0.	0.1	0.	.001
GM		1	0.	0.3	0.	0.1	0.3	0.	.001
GM		4	0.	0.	0.	0.1	0.	0.	.001
GM		3	0.5	0.	0.	0.5	0.3	0.	.001
GM		1	0.	0.	0.	-0.25	-0.15	0.	.001
GM	1	5	-0.25	0.	0.15	0.25	0.	0.15	.001
GE									

Number of Segments: 43

Symmetry: None

The first 6 cards generate data for the wire grid plate, with the lower left-hand corner at the coordinate origin, by using the GM card to reproduce sections of the structure. The GM card is then used to move the center of the plate to the origin. Finally, a wire is generated 0.15 meters above the plate with a tag of 1.

Cylinder with Attached Wires

Structure: figure 12

Geometry Data Cards:

2	10	20	30	40	50	60	70	80
SP		10.	0.	7.3333	0.	0.	38.4	
SP		10.	0.	0.	0.	0.	38.4	
SP		10.	0.	7.3333	0.	0.	38.4	
GM	1	0.	0.	30.				
SP		6.89	0.	11.	90.	0.	44.89	
SP		6.89	0.	-11.	-90.	0.	44.89	
SP	6	0.	0.	11.	90.	0.	44.89	
SP		0.	0.	-11.	-90.	0.	44.89	
GM	4	0.	0.	11.	0.	0.	23.	.1
GM	5	10.	0.	0.	27.6	0.	0.	.2
GS		.01						
GE								

Number of Segments: 9

Number of Patches: 56

Symmetry: None

The cylinder is generated by first specifying three patches in a column centered on the X axis as shown in figure 12(a). A GM card is then used to produce a second column of patches rotated about the Z axis by 30 degrees. A patch is added to the top and another to the bottom to form parts of the end surfaces. The model at this point is shown in figure 12(b). Next a GR card is used to rotate this section of patches about the Z axis to form a total of six similar sections, including the original. A patch is then added to the center of the top and

another to the bottom to form the complete cylinder shown in figure 12(c). Finally, two GW cards are used to add wires connecting to the top and side of the cylinder. The patches to which the wires are connected are divided into four smaller patches as shown in figure 12(d). Although patch shape is not input to the program, square patches are assumed at the base of a connected wire when integrating over the surface current. Hence, a more accurate representation of the model would be as shown in figure 13, where the patches to which wires connect are square with equal areas maintained for all patches (before subdivision).

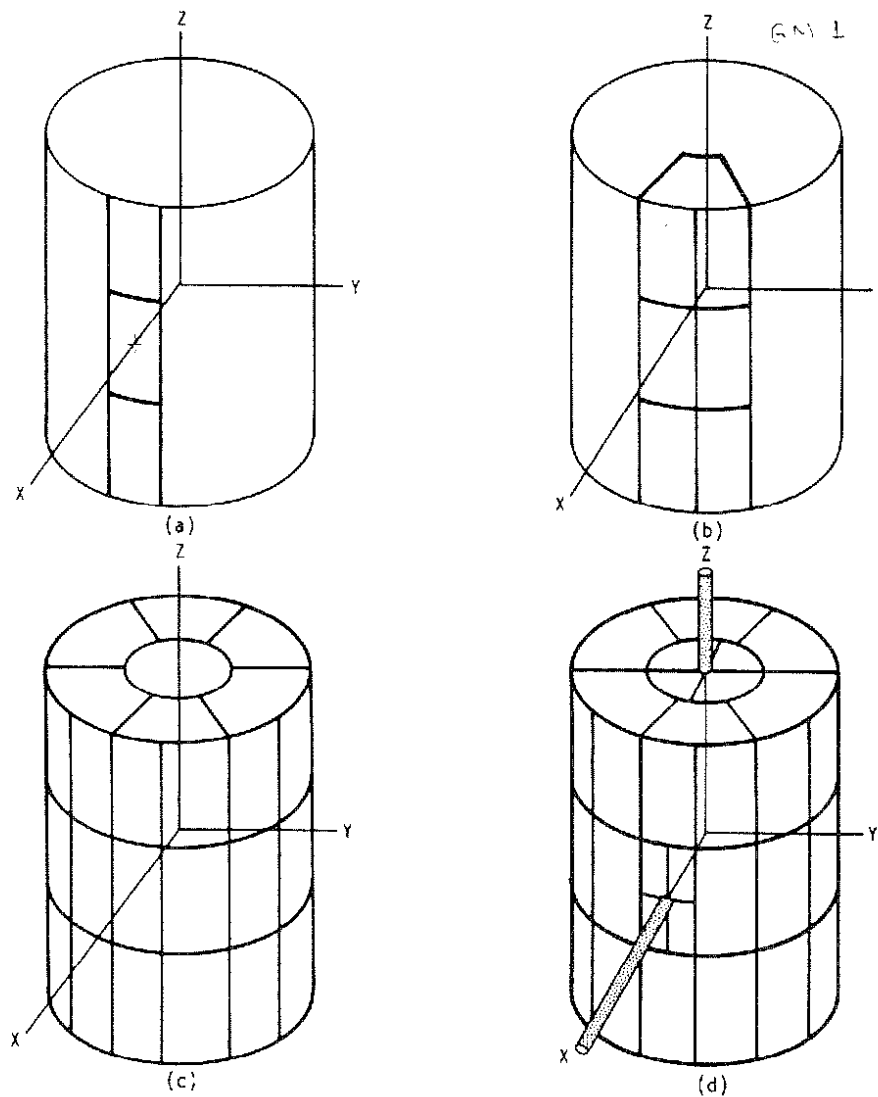

Figure 12. Development of Surface Model for Cylinder with Attached Wires.

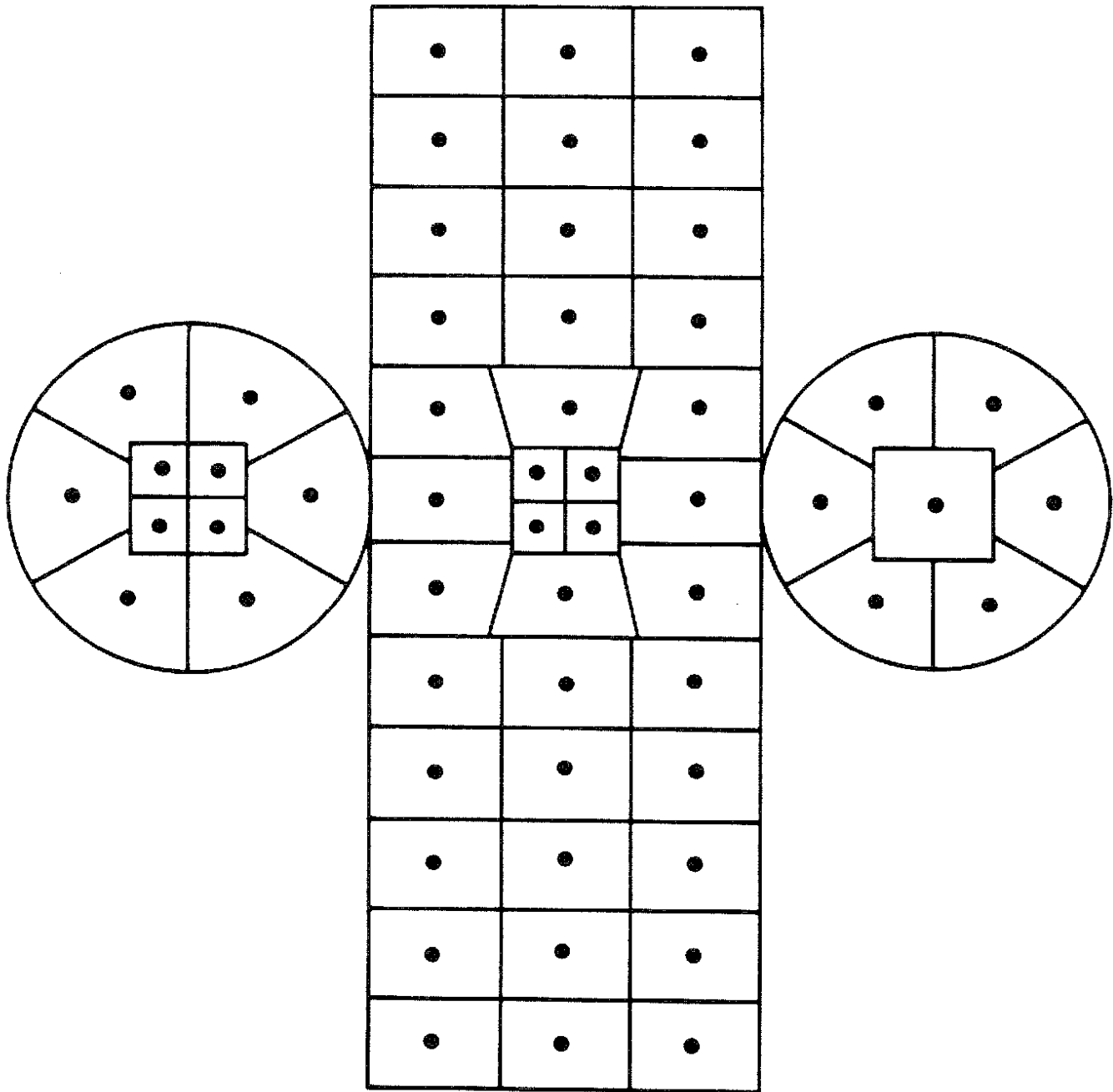

Figure 13. Segmentation of Cylinder for Wires Connected to End and Side.

3. PROGRAM CONTROL CARDS

The program control cards follow the structure geometry cards. They set electrical parameters for the model, select options for the solution procedure, and request data computation. The cards are listed below by their mnemonic identifier with a brief description of their function:

- I { EK - extended thin-wire kernel flag
- FR - frequency specification
- GN - ground parameter specification
- KH - interaction approximation range
- LD - structure impedance loading

- II { EX - structure excitation card
- NT - two-port network specification
- TL - transmission line specification

- III { CP - coupling calculation
- EN - end of data flag
- GD - additional ground parameter specifications
- NE - near electric field request
- NH - near magnetic field request
- NX - next structure flag
- PQ - wire charge density print control
- PT - wire-current print control
- RP - radiation pattern request
- WG - write Numerical Green's Function file
- XQ - execute card

There is no fixed order for the cards. The desired parameters and options are set first followed by requests for calculation of currents, near fields and radiated fields. Parameters that are not set in the input data are given default values. The one exception to this is the excitation (EX) which must be set

Computation of currents may be requested by an XQ card. RP, NE, or NH cards cause calculation of the currents and radiated or near fields on the first occurrence. Subsequent RP, NE, or NH cards cause computation of fields using the previously calculated currents. Any number of near-field and radiation-pattern requests may be grouped together in a data deck. An exception to this occurs when multiple frequencies are requested by a single FR

card. In this case, only a single NE or NH card and a single RP card will remain in effect for all frequencies.

All parameters retain their values until changed by subsequent data cards. Hence, after parameters have been set and currents or fields computed, selected parameters may be changed and the calculations repeated. For example, if a number of different excitations are required at a single frequency, the deck could have the form FR, EX, XQ, EX, XQ, ... If a single excitation is required at a number of frequencies, the cards EX, FR, XQ, FR, XQ, ... could be used.

When the antenna is modified and additional calculations are requested, the order of the cards may, in some cases, affect the solution time since the program will repeat only that part of the solution affected by the changed parameters. For this reason, the user should understand the relation of the data cards to the solution procedure. The first step in the solution is to calculate the interaction matrix, which determines the response of the antenna to an arbitrary excitation, and to factor this matrix in preparation for solution of the matrix equation. This is the most time-consuming single step in the solution procedure. The second step is to solve the matrix equation for the currents due to a specific excitation. Finally, the near fields or radiated fields may be computed from the currents.

The interaction matrix depends only on the structure geometry and the cards in group I of the program control cards. Thus, computation and factorization of the matrix is not repeated if cards beyond group I are changed. On the other hand, antenna currents depend on both the interaction matrix and the cards in group II, so that the currents must be recomputed whenever cards in group I or II are changed. The near fields depend only on the structure currents while the radiated fields depend on the currents and on the GD card, which contains special ground parameters for the radiated-field calculation. An example of the implications of these rules is presented by the following two sets of data cards:

```
FR, EX, NT1, LD1, XQ, LD2, XQ, NT2, LD1, XQ, LD2, XQ
FR, EX, LD1, NT1, XQ, NT2, XQ, LD2, NT1, XQ, NT2, XQ
```

Calculation and factoring of the matrix would be required four times by the first set but only twice by the second set in obtaining the same information.

The program control cards are explained on the following pages. The format of all program control cards has four integers and six floating point

numbers. The integers are contained in columns 3 through 5, 6 through 10, 11 through 15, and 16 through 20 (each integer field stops at an integral multiple of 5 columns), and the floating point numbers are contained in fields of 10 for the remainder of the card (i.e., from 21 through 30, 31 through 40, etc.). Integers are right justified in their fields. The floating point numbers can be punched either as a string of digits containing a decimal point, punched anywhere in the field; or as a string of digits containing a decimal point and followed by an exponent of ten in the form $E \pm I$ which multiplies the number by $10^{\pm I}$. The integer exponent must be right justified in the field.

Maximum Coupling Calculation (CP)

Purpose: To request calculation of the maximum coupling between segments.

Card:

	2	5	10	15	20	30	40	50	60	70	80
CP	11	12	13	14	blank	blank	blank	blank	blank	blank	blank
	TAG1	SEG1	TAG2	SEG2							
					The numbers along the top refer to the last column in each field.						

Parameters:

TAG1	(I1)	} Specify segment number SEG1 in the set of segments having tag TAG1. If TAG1 is blank or zero, then SEG1 is the segment number.
SEG1	(I2)	
TAG2	(I3)	} Same as above
SEG2	(I4)	

Notes:

- Up to five segments may be specified on 2-1/2 CP cards. Coupling is computed between all pairs of these segments. When more than two segments are specified, the CP cards must be grouped together. A new group of CP cards replaces the old group.
- CP does not cause the program to proceed with the calculation but only sets the segment numbers. The specified segments must then be excited (EX card) one at a time in the specified order and the currents computed (XQ, RP, NE, or NH card). The excitation must use the applied-field voltage-source model. When all of the specified segments have been excited in the proper order, the couplings will be computed and printed. After the coupling calculation the set of CP cards is cancelled.

Extended Thin-Wire Kernel (EK)

Purpose: To control use of the extended thin-wire kernel approximation.

Card:

	2	5	10	15	20	30	40	50	60	70	80
EK	11		blank	blank	blank	blank	blank	blank	blank	blank	blank
	ITMP1										

The numbers along the top refer to the last column in each field.

Parameters:

Integers

ITMP1 (11) - Blank or zero to initiate use of the extended thin-wire kernel, -1 to return to standard thin-wire kernel. Without an EK card, the program will use the standard thin-wire kernel.

End of Run (EN)

Purpose: To indicate to the program the end of all execution.

Card:

2	5	10	15	20	30	40	50	60	70	80
EN	blank	blank	blank	blank	blank	blank	blank	blank	blank	blank
The numbers along the top refer to the last column in each field.										

Parameters: None

Excitation (EX)

Purpose: To specify the excitation for the structure. The excitation can be voltage sources on the structure, an elementary current source, or a plane-wave incident on the structure.

Card:

	2	5	10	15	20	30	40	50	60	70	80
EX	I1	I2	I3	I4	F1	F2	F3	F4	F5	F6	
The numbers along the top refer to the last column in each field.											

Parameters:

Integers

- (I1) - Determines the type of excitation which is used.
- 0 - voltage source (applied-E-field source).
 - 1 - incident plane wave, linear polarization.
 - 2 - incident plane wave, right-hand (thumb along the incident k vector) elliptic polarization.
 - 3 - incident plane wave, left-hand elliptic polarization.
 - 4 - elementary current source.
 - 5 - voltage source (current-slope-discontinuity).

Remaining Integers Depend on Excitation Type

- a. Voltage source ((I1) = 0 or 5)
- (I2) - Tag number of the source segment. This tag number along with the number to be given in (I3), which identifies the position of the segment in a set of equal tag numbers, uniquely defines the source segment. Blank or zero in field (I2) implies that the source segment will be identified by using the absolute segment number in the next field.
- (I3) - Equal to m, specifies the mth segment of the set of segments whose tag numbers are equal to the number

set by the previous parameter. If the previous parameter is zero, the number in (I3) must be the absolute segment number of the source.

(I4) - Columns 19 and 20 of this field are used separately.

The options for column 19 are:

1 - maximum relative admittance matrix asymmetry for source segments and network connections will be calculated and printed.

0 - no action.

The options for column 20 are:

1 - the input impedance at voltage sources is always printed directly before the segment currents in the output. By setting this flag, the impedances of a single source segment in a frequency loop will be collected and printed in a table (in a normalized and unnormalized form) after the information at all frequencies has been printed. Normalization to the maximum value is a default, but the normalization value can be specified (refer to F3 under voltage source below). When there is more than one source on the structure, only the impedance of the last source specified will be collected.

0 - no action.

b. Incident plane wave ((I1) = 1, 2, or 3)

(I2) - Number of theta angles desired for the incident plane wave.

(I3) - Number of phi angles desired for the incident plane wave.

(I4) - Only column 19 is used. The options are:

1 - maximum relative admittance matrix asymmetry for network connections will be calculated and printed.

0 - no action.

- c. Elementary current source ((I1) = 4)
 (I2) & (I3) - blank.
 (I4) - Only column 19 is used and its function is identical to that listed under b.

Floating Point Options

- a. Voltage source ((I1) = 0 or 5)
 (F1) - Real part of the voltage in volts.
 (F2) - Imaginary part of the voltage in volts.
 (F3) - If a one is placed in column 20 (see above), this field can be used to specify a normalization constant for the impedance printed in the optional impedance table. Blank in this field produces normalization to the maximum value.
 (F4), (F5), & (F6) - Blank.
- b. Incident plane wave ((I1) = 1, 2, or 3). The incident wave is characterized by the direction of incidence \hat{k} and polarization in the plane normal to \hat{k} .
 (F1) - Theta in degrees. Theta is defined in standard spherical coordinates as illustrated in figure 14.
 (F2) - Phi in degrees. Phi is the standard spherical angle defined in the XY plane.
 (F3) - Eta in degrees. Eta is the polarization angle defined as the angle between the theta unit vector and the

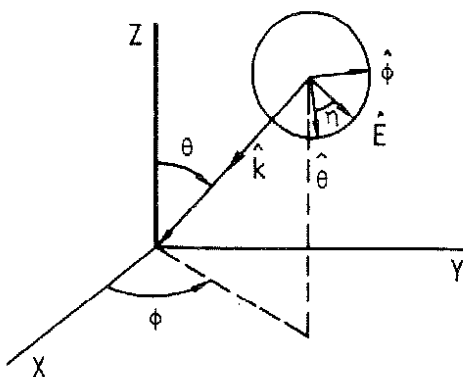

Figure 14. Specification of Incident Wave.

direction of the electric field for linear polarization or the major ellipse axis for elliptical polarization. Refer to figure 14.

- (F4) - Theta angle stepping increment in degrees.
- (F5) - Phi angle stepping increment in degrees.
- (F6) - Ratio of minor axis to major axis for elliptic polarization (major axis field strength = 1 V/m).

c. Elementary current source ($l = 4$). The current source is characterized by its Cartesian coordinate position, its orientation, and its magnitude.

- (F1) - X position in meters.
- (F2) - Y position in meters.
- (F3) - Z position in meters.
- (F4) - α in degrees. α is the angle the current source makes with the XY plane as illustrated in figure 15.
- (F5) - β in degrees. β is the angle the projection of the current source on the XY plane makes with the X axis.
- (F6) - "Current moment" of the source. This parameter is equal to the product $I\ell$ in amp meters.

Notes:

- In the case of voltage sources, excitation cards can be grouped together in order to specify multiple sources. The maximum number of voltage sources that may be specified is determined by dimension statements in the program. The dimensions are set for 10 applied-E-field voltage sources and 10 current-slope-discontinuity voltage sources.

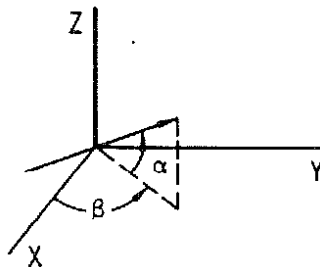

Figure 15. Orientation of Current Element.

- The applied-E-field voltage source is located on the segment specified.
- The current-slope-discontinuity voltage source is located at the first end, relative to the reference direction, of the specified segment, at the junction between the specified segment and the previous segment. This junction must be a simple two-segment junction, and the two segments must be parallel with equal lengths and radii.
- A current-slope-discontinuity voltage source may lie in a symmetry plane. An applied field voltage source may not lie in a symmetry plane since a segment may not lie in a symmetry plane. An applied field voltage source may be used on a wire crossing a symmetry plane by exciting the two segments on opposite sides of the symmetry plane each with half the total voltage, taking account of the reference directions of the two segments.
- An applied field voltage source specified on a segment which has been impedance-loaded, through the use of an LD card, is connected in series with the load. An applied field voltage source specified on the same segment as a network is connected in parallel with the network port. For the specific case of a transmission line, the source is in parallel with both the line and the shunt load. Applied field voltage sources should be used in these cases since loads and network connections are located on, rather than between, segments.
- Only one incident plane wave or one elementary current source is allowed at a time. Also plane-wave or current-source excitation is not allowed with voltage sources. If the excitation types are mixed, the program will use the last excitation type encountered.
- When a number of theta and phi angles are specified for an incident plane-wave excitation, the theta angle changes more rapidly than phi.
- The current element source illuminates the structure with the field of an infinitesimal current element at the specified location. The current element source cannot be used over a ground plane.

Frequency (FR)

Purpose: To specify the frequency(s) in megahertz.

Card:

2	5	10	15	20	30	40	50	60	70	80
FR	I1	I2	I3	I4	F1	F2	blank	blank	blank	blank
	IFRQ	NFRQ	blank	blank	FMHZ	DELFRQ				
The numbers along the top refer to the last column in each field.										

Parameters:

Integers

IFRQ (I1) - Determines the type of frequency stepping which is used.

0 - linear stepping.

1 - multiplicative stepping.

NFRQ (I2) - Number of frequency steps. If this field is blank, one is assumed.

(I3) & (I4) - Blank.

Floating Point

FMHZ (F1) - Frequency in megahertz.

DELFRQ (F2) - Frequency stepping increment. If the frequency stepping is linear, this quantity is added to the frequency each time. If the stepping is multiplicative, this is the multiplication factor.

(F3)---(F6) - Blank.

Notes:

- If a frequency card does not appear in the data deck, a single frequency of 299.8 MHz is assumed. Since the wavelength at 299.8 MHz is one meter, the geometry is in units of wavelengths for this case.
- Frequency cards may not be grouped together. If they are, only the information on the last card in the group will be used.

- After an FR card with NFRQ greater than 1, an NE or NH card will not initiate execution while an RP or XQ card will. In this case, only one NE or NH card and one RP card will be effective for the multiple frequencies.
- After a frequency loop for NFRQ greater than one has been completed, it will not be repeated for a second execution request. The FR card must be repeated in this case.

Additional Ground Parameters (GD)

Purpose: To specify the ground parameters of a second medium which is not in the immediate vicinity of the antenna. This card may only be used if a GN card has also been used. It does not affect the field of surface patches.

Card:

2	5	10	15	20	30	40	50	60	70	80
GD	blank	blank	blank	blank	F1	F2	F3	F4	blank	blank
					EPSR2	SIG2	CLT	CHT		
The numbers along the top refer to the last column in each field.										

Parameters:

Integers

All integer fields are blank.

Floating Point

EPSR2 (F1) — Relative dielectric constant of the second medium.

SIG2 (F2) — Conductivity in mhos/meter of the second medium.

CLT (F3) — Distance in meters from the origin of the coordinate system to the join between medium 1 and 2. This distance is either the radius of the circle where the two media join or the distance out the plus X axis to where the two media join in a line parallel to the Y axis. Specification of the circular or linear option is on the RP card. See figure 16.

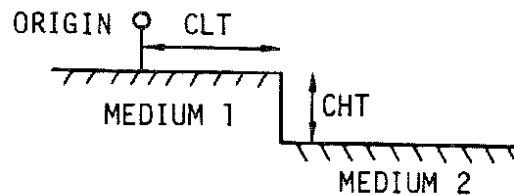

Figure 16. Parameters for a Second Ground Medium.

CHT (F4) — Distance in meters (positive or zero) by which the surface of medium 2 is below medium 1.
(F5) & (F6) — Blank.

Notes:

- The GD card can only be used in a data set where the GN card has been used since the GN card is the only way to specify the ground parameters in the vicinity of the antenna (see GN card write-up). However, a number of GD cards may be used in the same data set with only one GN card.
- GD cards may not be grouped together. If they are, only the information on the last card of the group is retained.
- When a second medium is specified, a flag must also be set on the radiation-pattern (RP) data card in order to calculate the patterns including the effect of the second medium. Refer to the radiation-pattern card write-up for details.
- Use of the GD card does not require recalculation of the matrix or currents.
- The parameters for the second medium are used only in the calculation of the far fields. It is possible then to set the radius of the boundary between the two media equal to zero and thus have the far fields calculated by using only the parameters of medium 2. The currents for this case will still have been calculated by using the parameters of medium 1.
- When a model includes surface patches, the fields due to the patches will be calculated by using only the primary ground parameters. Hence, a second ground medium should not be used with patches.

Ground Parameters (GN)

Purpose: To specify the relative dielectric constant and conductivity of ground in the vicinity of the antenna. In addition, a second set of ground parameters for a second medium can be specified, or a radial wire ground screen can be modeled using a reflection coefficient approximation.

Card:

2	5	10	15	20	30	40	50	60	70	80
GN	11	12	14	15	F1	F2	F3	F4	F5	F6
	IPERF	NRADL	blank	blank	EPSR	SIG				
The numbers along the top refer to the last column in each field.										

Parameters:

Integers

- IPERF (I1) — Ground-type flag. The options are:
- 1 — nullifies ground parameters previously used and sets free-space condition. The remainder of the card is left blank in this case.
 - 0 — finite ground, reflection coefficient approximation.
 - 1 — perfectly conducting ground.
 - 2 — finite ground, Sommerfeld/Norton method.

NRADL (I2) — Number of radial wires in the ground screen approximation, blank or 0 implies no ground screen.

(I3) & (I4) — Blank.

Floating Point

EPSR (F1) — Relative dielectric constant for ground in the vicinity of the antenna. Leave blank in case of a perfect ground.

SIG (F2) — Conductivity in mhos/meter of the ground in the vicinity of the antenna. Leave blank in case of a perfect ground. If SIG is input as a negative number, the complex dielectric constant $\epsilon_c = \epsilon_r - j\sigma/\omega\epsilon_0$ is set to $\text{EPSR} - j|\text{SIG}|$.

Options for Remaining Floating Point Fields (F3-F6)

- a. For the case of an infinite ground plane, F3 through F6 are blank.
- b. Radial wire ground screen approximation ($NRADL \neq 0$). The ground screen is always centered at the origin, i.e., (0,0,0) and lies in the XY plane.
 - (F3) - The radius of the screen in meters.
 - (F4) - Radius of the wires used in the screen in meters.
 - (F5) & (F6) - Blank.
- c. Second medium parameters ($NRADL = 0$) for medium outside the region of the first medium (cliff problem). These parameters alter the far field patterns but do not affect the antenna impedance or current distribution.
 - (F3) - Relative dielectric constant of medium 2.
 - (F4) - Conductivity of medium 2 in mhos/meter.
 - (F5) - Distance in meters from the origin of the coordinate system to join between medium 1 and 2. This distance is either the radius of the circle where the two media join or the distance out the positive X axis to where the two media join in a line parallel to the Y axis. Specification of the circular or linear option is on the RP card. See figure 16.
 - (F6) - Distance in meters (positive or zero) by which the surface of medium 2 is below medium 1.

Notes:

- When the Sommerfeld/Norton method is used, NEC requires an input-data file (TAPE21) that is generated by the program SOMNEC for the specific ground parameters and frequency (see section III-4). The file generated by SOMNEC depends only on the complex dielectric constant, $\epsilon_c = \epsilon_r - j\sigma/\omega\epsilon_0$. NEC compares ϵ_c from the file with that determined by the GN card parameters and frequency. If the relative difference exceeds 10^{-3} an error message is printed. Once TAPE21 has been read for the first use of the Sommerfeld/Norton method the data is retained until the end of the run. Subsequent data, including new data sets following NX cards, may use the TAPE21 data if the ground parameters and frequency (ϵ_c) remain unchanged. Other ground options may be intermixed with the Sommerfeld/Norton option.

- The parameters of the second medium can also be specified on another data card whose mnemonic is GD. With the GD card, the parameters of the second medium can be varied and only the radiated fields need to be recalculated. Furthermore, if a radial wire ground screen has been specified on the GN card, the GD card is the only way to include a second medium. See the write-up of the GD card for details.
- GN cards may not be grouped together. If they are, only the information on the last card will be retained.
- Use of a GN card after any form of execute dictates structure matrix regeneration.
- Only the parameters of the first medium are used when the antenna currents are calculated; the parameters associated with the second medium are not used until the calculation of the far fields. It is possible then to calculate the currents over one set of ground parameters (medium one), but to calculate the far fields over another set (medium two) by setting the distance to the start of medium two to zero. Medium one can even be a perfectly conducting ground specified by IPERF=1.
- When a radial wire ground screen or a second medium is specified, it is necessary to indicate their presence by the first parameter on the RP card in order to generate the proper radiation patterns.
- When a ground plane is specified, this fact should also be indicated on the GE card. Refer to the GE card for details.
- When a model includes surface patches, the fields due to the patches will be calculated by using only the primary ground parameters. Hence, a second ground medium should not be used with patches. The radial wire ground screen approximation also is not implemented for patches.

Interaction Approximation Range (KH)

Purpose: To set the minimum separation distance for use of a time-saving approximation in filling the interaction matrix.

Card:

2	5	10	15	20	30	40	50	60	70	80
KH					F1	Blank	Blank	Blank	Blank	Blank
	Blank	Blank	Blank	Blank	RKH					
The numbers along the top refer to the last column in each field.										

Parameters:

Integers - None

Decimal Numbers

RKH (F1) - The approximation is used for interactions over distances greater than RKH wavelengths.

Notes:

- If two segments or a segment and a patch are separated by more than RKH wavelengths, the interaction field is computed from an impulse approximation to the segment current. The field of a current element located at the segment center is used. No approximation is used for the field due to the surface current on a patch since the time for the standard calculation is very short.
- The KH card can be placed anywhere in the data cards following the geometry cards (with FR, EX, LD, etc.) and affects all calculations requested following its occurrence. The value of RKH may be changed within a data set by use of a new KH card.

Loading (LD)

Purpose: To specify the impedance loading on one segment or a number of segments. Series and parallel RLC circuits can be generated. In addition, a finite conductivity can be specified for segments.

Card:

2	5	10	15	20	30	40	50	60	70	80
LD	I1	I2	I3	I4	F1	F2	F3	blank	blank	blank
	LDTYP	LDTAG	LDTAGF	LDTAGT	ZLR	ZLI	ZLC			
The numbers along the top refer to the last column in each field.										

Parameters:

Integers

- LDTYP (I1) - Determines the type of loading which is used. The options are:
- 1 - short all loads (used to nullify previous loads).
The remainder of the card is left blank.
 - 0 - series RLC, input ohms, henries, farads.
 - 1 - parallel RLC, input ohms, henries, farads.
 - 2 - series RLC, input ohms/meter, henries/meter, farads/meter.
 - 3 - parallel RLC, input ohms/meter, henries/meter, farads/meter.
 - 4 - impedance, input resistance and reactance in ohms.
 - 5 - wire conductivity, mhos/meter.
- LDTAG (I2) - Tag number; identifies the wire section(s) to be loaded by its (their) tag numbers. The next two parameters can be used to further specify certain segment(s) on the wire section(s). Blank or zero here implies that absolute segment numbers are being used in the next two parameters to identify segments.

If the next two parameters are blank or zero, all segments with tag LDTAG are loaded.

LDTAGF (I3) - Equal to m specifies the m^{th} segment of the set of segments whose tag numbers equal the tag number specified in the previous parameter. If the previous parameter (LDTAG) is zero, LDTAGF then specifies an absolute segment number. If both LDTAG and LDTAGF are zero, all segments will be loaded.

LDTAGT (I4) - Equal to n specifies the n^{th} segment of the set of segments whose tag numbers equal the tag number specified in the parameter LDTAG. This parameter must be greater than or equal to the previous parameter. The loading specified is applied to each of the m^{th} through n^{th} segments of the set of segments having tags equal to LDTAG. Again if LDTAG is zero, these parameters refer to absolute segment numbers. If LDTAGT is left blank, it is set equal to the previous parameter (LDTAGF).

Floating Point Input for the Various Load Types

a. Series RLC () (LDTYP = 0)

ZLR (F1) - Resistance in ohms, if none, leave blank.

ZLI (F2) - Inductance in henries, if none, leave blank.

ZLC (F3) - Capacitance in farads, if none, leave blank.

b. Parallel RLC () (LDTYP = 1),
floating point input same as a.

c. Series RLC (LDTYP = 2) input, parameters per unit length.

ZLR - Resistance in ohms/meter, if none, leave blank.

ZLI - Inductance in henries/meter, if none, leave blank.

ZLC - Capacitance in farads/meter, if none, leave blank.

d. Parallel RLC (LDTYP = 3), input parameters per unit length,
floating point input same as c.

- e. Impedance (LDTYP = 4)
 - ZLR - Resistance in ohms.
 - ZLI - Reactance in ohms.
- f. Wire conductivity (LDTYP = 5)
 - ZLR - Conductivity in mhos/meter.

Notes:

- Loading cards can be input in groups to achieve a desired structure loading. The maximum number of loading cards in a group is determined by dimensions in the program. The limit is presently 30.
- If a segment is loaded more than once by a group of loading cards, the loads are assumed to be in series (impedances added), and a comment is printed in the output alerting the user to this fact.
- When resistance and reactance are input (LDTYP = 4), the impedance does not automatically scale with frequency.
- Loading cards used after any form of execute, require the regeneration of the structure matrix.
- Since loading modifies the interaction matrix, it will affect the conditions of plane or cylindrical symmetry of a structure. If a structure is geometrically symmetric and each symmetric section is to receive identical loading, then symmetry may be used in the solution. The program is set to utilize symmetry during geometry input by inputting the data for one symmetric section and completing the structure with a GR or GX card. If symmetry is used, the loading on only the first symmetric section is input on LD cards. The same loading will be assumed on the other sections. Loading should not be specified for segments beyond the first section when symmetry is used. If the sections are not identically loaded, then during geometry input the program must be set to a no-symmetry condition to permit independent loading of corresponding segments in different sections.

Near Fields (NE, NH)

Purpose: To request calculation of near electric fields in the vicinity of the antenna (NE) and to request near magnetic fields (NH).

Card:

	2	5	10	15	20	30	40	50	60	70	80
NE	I1	I2	I3	I4	F1	F2	F3	F4	F5	F6	
NH	NEAR	NRX	NRZ	NRZ	XNR	YNR	ZNR	DXNR	DYNR	DZNR	

The numbers along the top refer to the last column in each field.

Parameters:

Integers

NEAR (I1) - Coordinate system type. The options are:
 0 - rectangular coordinates will be used.
 1 - spherical coordinates will be used.

Remaining Integers Depend on Coordinate Type

a. Rectangular coordinates (NEAR = 0)

NRX (I2) - } Number of points desired in the X, Y, and
 NRY (I3) - } Z directions respectively. X changes
 NRZ (I4) - } the most rapidly, then Y, and then Z.

The value 1 is assumed for any field left blank.

b. Spherical coordinates (NEAR = 1)

(I2) - } Number of points desired in the r, ϕ , and θ directions,
 (I3) - } respectively. r changes the most rapidly, then ϕ , and
 (I4) - } then θ . The value 1 is assumed for any field left
 blank.

Floating Point Fields

Their specification depends on the coordinate system chosen.

a. Rectangular coordinates (NEAR = 0)

XNR (F1) -	}	The (X, Y, Z) coordinate position (F1, F2, F3) respectively, in meters of the first field point.
YNR (F2) -		
ZNR (F3) -		
DXNR (F4) -	}	Coordinate stepping increment in meters for the X, Y, and Z coordinates (F4, F5, F6), respectively.
DYNR (F5) -		
DZNR (F6) -		

In stepping, X changes most rapidly, then Y, and then Z.

b. Spherical coordinates (NEAR = 1)

(F1) -	}	The (r, ϕ , θ) coordinate position (F1, F2, F3) respectively, of the first field point. r is in meters, and ϕ and θ are in degrees.
(F2) -		
(F3) -		
(F4) -	}	Coordinate stepping increments for r, ϕ , and θ (F4, F5, F6), respectively. The stepping increment for r is in meters, and for ϕ and θ is in degrees.
(F5) -		
(F6) -		

Notes:

- When only one frequency is being used, near-field cards may be grouped together in order to calculate fields at points with various coordinate increments. For this case, each card encountered produces an immediate execution of the near-field routine and the results are printed. When automatic frequency stepping is being used [i.e., when the number of frequency steps (NFRQ) on the FR card is greater than one], only one NE or NH card can be used for program control inside the frequency loop. Furthermore, the NE or NH card does not cause an execution in this case. Execution will begin only after a subsequent radiation-pattern card (RP) or execution card (XQ) is encountered (see respective write-ups on both of these cards).
- The time required to calculate the field at one point is equivalent to filling one row of the matrix. Thus, if there are N segments in the structure, the time required to calculate fields at N points is equivalent to the time required to fill an $N \times N$ interaction matrix.

- The near electric field is computed by whichever form of the field equations selected for filling the matrix, either the thin-wire approximation or extended thin-wire approximation. At large distances from the structure, the segment currents are treated as infinitesimal current elements.
- If the field calculation point falls within a wire segment, the point is displaced by the radius of that segment in a direction normal to the plane containing each source segment and the vector from that source segment to the observation segment. When the specified field-calculation point is at the center of a segment, this convention is the same as is used in filling the interaction matrix. If the field point is on a segment axis, that segment produces no contribution to the H-field or the radial component of the E-field. If these components are of interest, the field point should be on or outside of the segment surface.

Networks (NT)

Purpose: To generate a two-port nonradiating network connected between any two segments in the structure. The characteristics of the network are specified by its short-circuit admittance matrix elements. For the special case of a transmission line, a separate card is provided for convenience although the mathematical method is the same as for networks. Refer to the TL card.

Card:

2	5	10	15	20	30	40	50	60	70	80
NT	I1	I2	I3	I4	F1	F2	F3	F4	F5	F6
					Y11R	Y11I	Y12R	Y12I	Y22R	Y22I
The numbers along the top refer to the last column in each field.										

Parameters:

Integers

- (I1) - Tag number of the segment to which port one of the network is connected. This tag number along with the number to be given in (I2), which identifies the position of the segment in a set of equal tag numbers, uniquely defines the segment for port one. Blank or zero here implies that the segment will be identified, using the absolute segment number in the next location (I2).
- (I2) - Equal to m, specifies the mth segment of the set of segments whose tag numbers are equal to the number set by the previous parameter. If the previous parameter is zero, the number in (I2) is the absolute segment number corresponding to end one of the network. A minus one in this field will nullify all previous network and transmission line connections. The rest of the card is left blank in this case.
- (I3) & (I4) - Used in exactly the same way as (I1) & (I2) in order to specify the segment corresponding to port two of the network connection.

Floating Point

The six floating-point fields are used to specify the real and imaginary parts of three short circuit admittance matrix elements (1, 1), (1, 2), and (2, 2), respectively. The admittance matrix is symmetric so it is unnecessary to specify element (2, 1).

Y11R (F1) — Real part of element (1, 1) in mhos.

Y11I (F2) — Imaginary part of element (1, 1) in mhos.

Y12R (F3) — Real part of element (1, 2) in mhos.

Y12I (F4) — Imaginary part of element (1, 2) in mhos.

Y22R (F5) — Real part of element (2, 2) in mhos.

Y22I (F6) — Imaginary part of element (2, 2) in mhos.

Notes:

- Network cards may be used in groups to specify several networks on a structure. All network cards for a network configuration must occur together with no other cards (except TL cards) separating them. When the first NT card is read following a card other than an NT or TL card, all previous network and transmission line data are destroyed. Hence, if a set of network data is to be modified, all network data must be input again in the modified form. Dimensions in the program limit the number of networks that may be specified. In the present NEC deck, the number of two-port networks (including transmission lines) is limited to thirty, and the number of different segments having network ports connected to them is limited to thirty.
- One or more network ports can be connected to any given segment. Multiple network ports connected to one segment are connected in parallel.
- If a network is connected to a segment which has been impedance loaded (i.e., through the use of the LD card), the load acts in series with the network port.
- A voltage source specified on the same segment as a network port is connected in parallel with the network port.
- Segments can be impedance-loaded by using network cards. Consider a network connected from the segment to be loaded to some other arbitrary segment as shown in figure 17. The admittance matrix

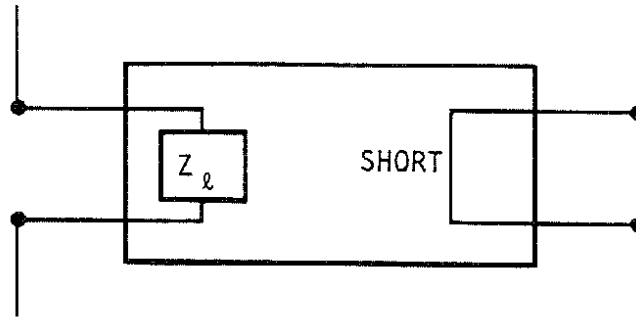

Figure 17. Segment Loaded by Means of a 2-Port Network.

elements are $Y_{11} = 1/Z_l$, $Y_{12} = 0$, and $Y_{22} = \text{infinity}$ (computationally, a very large number such as 10^{10}). The advantage of using this technique for loading is that the load can be changed without causing a recalculation of the structure matrix as is required when LD cards are used. Furthermore, in some cases a higher degree of structure matrix symmetry can be preserved because the matrix elements are not directly modified by networks as they are when using the LD cards. (Consider for instance a loop with one load where the loop is rotationally symmetric until the load is placed on it.) The disadvantage of the NT card form of loading is that the user must calculate the load admittance, and this value does not automatically scale with frequency. Obviously, in the above schematic, replacing the short with an impedance would load two segments. At a segment at which a voltage source is specified, the effect of loading by the LD and NT cards differs, however, since the network is in parallel with the voltage source while the load specified by an LD card is in series with the source.

- Use of network cards (NT) after any form of execute requires the recalculation of the current only.
- NT and TL cards do not affect structure symmetry.

Next Structure (NX)

Purpose: To signal the end of data for one structure and the beginning of data for the next structure.

Card:

2	5	10	15	20	30	40	50	60	70	80
NX	blank	blank	blank	blank	blank	blank	blank	blank	blank	blank
The numbers along the top refer to the last column in each field.										

Parameters: NX appears in the first two columns, and the rest of the card is blank.

Notes: The card that directly follows the NX card must be a comment card.

Print Control for Charge on Wires (PQ)

Purpose: To control the printing of charge densities on wire segments.

Card:

	2	5	10	15	20	30	40	50	60	70	80
PQ	11	12	13	14	blank	blank	blank	blank	blank	blank	blank
	IPTFLQ	IPTAQ	IPTAQF	IPTAQT							
					The numbers along the top refer to the last column in each field.						

Parameters:

Integers

IPTFLQ (11) - Print control flag:

-1 - suppress printing of charge densities. This is the default condition.

0 - (or blank) print charge densities on segments specified by the following parameters. If the following parameters are blank, charge densities are printed for all segments.

IPTAQ (12) - Tag number of the segments for which charge densities will be printed.

IPTAQF (13) - Equal to m specifies the m^{th} segment of the set of segments having tag numbers of IPTAQ. If IPTAQ is zero or blank, then IPTAQF refers to an absolute segment number. If IPTAQF is left blank, then charge density is printed for all segments.

IPTAQT (14) - Equal to n, specifies the n^{th} segment of the set of segments having tag numbers of IPTAQ. Charge densities are printed for segments having tag number IPTAQ starting at the m^{th} segment in the set and ending at the n^{th} segment. If IPTAQ is zero or blank, then IPTAQF and IPTAQT refer to absolute segment numbers. If IPTAQT is left blank, it is set equal to IPTAQF.

Print Control for Current on Wires (PT)

Purpose: To control the printing of currents on wire segments. Current printing can be suppressed, limited to a few segments, or special formats for receiving patterns can be requested.

Card:

	2	5	10	15	20	30	40	50	60	70	80
PT	11	12	13	14	blank	blank	blank	blank	blank	blank	blank
	IPTFLG	IPTAG	IPTAGF	IPTAGT							
					The numbers along the top refer to the last column in each field.						

Parameters:

Integers

IPTFLG (11) - Print control flag, specifies the type of format used in printing segment currents. The options are:

-2 - all currents printed. This is a default value for the program if the card is omitted.

-1 - suppress printing of all wire segment currents.

0 - current printing will be limited to the segments specified by the next three parameters.

1 - currents are printed by using a format designed for a receiving pattern (refer to output section in this manual). Only currents for the segments specified by the next three parameters are printed.

2 - same as for 1 above; in addition, however, the current for one segment will be normalized to its maximum, and the normalized values along with the relative strength in dB will be printed in a table. If the currents for more than one segment are being printed, only currents from the last segment in the group appear in the normalized table.

- 3 -- only normalized currents from one segment are printed for the receiving pattern case.
- IPTAG (I2) -- Tag number of the segments for which currents will be printed.
- IPTAGF (I3) -- Equal to m, specifies the m^{th} segment of the set of segments having the tag numbers of IPTAG, at which printing of currents starts. If IPTAG is zero or blank, then IPTAGF refers to an absolute segment number. If IPTAGF is blank, the current is printed for all segments.
- IPTAGT (I4) -- Equal to n, specifies the n^{th} segment of the set of segments having tag numbers of IPTAG. Currents are printed for segments having tag number IPTAG starting at the m^{th} segment in the set and ending at the n^{th} segment. If IPTAG is zero or blank, then IPTAGF and IPTAGT refer to absolute segment numbers. If IPTAGT is left blank, it is set equal to IPTAGF.

Radiation Pattern (RP)

Purpose: To specify radiation pattern sampling parameters and to cause program execution. Options for a field computation include a radial wire ground screen, a cliff, or surface-wave fields.

Card:

	2	5	10	15	20	30	40	50	60	70	80
RP	I1	I2	I3	I4	F1	F2	F3	F4	F5	F6	
		NTH	NPH	XNDA	THETS	PHIS	DTH	DPH	RFLD	GNOR	
The numbers along the top refer to the last column in each field.											

Parameters:

Integers

(I1) - This integer selects the mode of calculation for the radiated field. Some values of (I1) will affect the meaning of the remaining parameters on the card. Options available for I1 are:

- 0 - normal mode. Space-wave fields are computed. An infinite ground plane is included if it has been specified previously on a GN card; otherwise, antenna is in free space.
- 1 - surface wave propagating along ground is added to the normal space wave. This option changes the meaning of some of the other parameters on the RP card as explained below, and the results appear in a special output format. Ground parameters must have been input on a GN card.

The following options cause calculation of only the space wave but with special ground conditions. Ground conditions include a two medium ground (cliff) where the media join in a circle or a line, and a radial wire ground screen. Ground parameters and dimensions must be input

on a GN or GD card before the RP card is read. The RP card only selects the option for inclusion in the field calculation. (Refer to the GN and GD cards for further explanation.)

- 2 - linear cliff with antenna above upper level. Lower medium parameters are as specified for the second medium on the GN card or on the GD card.
- 3 - circular cliff centered at origin of coordinate system with antenna above upper level. Lower medium parameters are as specified for the second medium on the GN card or on the GD card.
- 4 - radial wire ground screen centered at origin.
- 5 - both radial wire ground screen and linear cliff.
- 6 - both radial wire ground screen and circular cliff.

The field point is specified in spherical coordinates (R, θ, ϕ) , illustrated in figure 18, except when the surface wave is computed. For computing the surface-wave field ($I_1 = 1$), cylindrical coordinates (ρ, ϕ, z) are used to accurately define points near the ground plane at large radial distances. The RP card allows automatic stepping of the field point to compute the field over a region about the antenna at uniformly spaced points. The integers I2 and I3 and floating point numbers F1, F2, F3 and F4 control the field-point stepping.

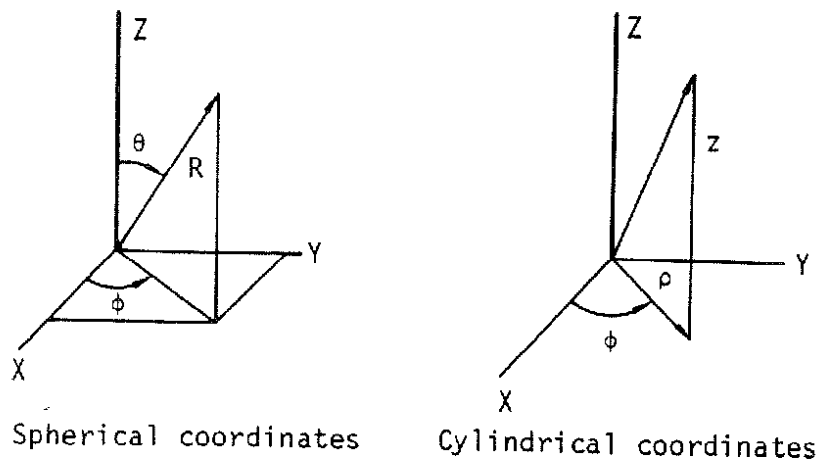

Figure 18. Coordinates for Radiated Field.

- NTH (I2) - Number of values of theta (θ) at which the field is to be computed (number of values of z for I1 = 1).
- NPH (I3) - Number of values of phi (ϕ) at which field is to be computed. The total number of field points requested by the card is NTH \times NPH. If I2 or I3 is left blank, a value of one will be assumed.
- XNDA (I4) - This optional integer consists of four independent digits in columns 17, 18, 19 and 20, each having a different function. The mnemonic XNDA is not a variable name in the program. Rather, each letter represents a mnemonic for the corresponding digit in I4. If I1 = 1, then I4 has no effect and should be left blank.
- X - (column 17) controls output format.
 X = 0 major axis, minor axis and total gain printed.
 X = 1 vertical, horizontal and total gain printed.
- N - (column 18) causes normalized gain for the specified field points to be printed after the standard gain output. The number of field points for which the normalized gain can be printed is limited by an array dimension in the program. In the demonstration program, the limit is 600 points. If the number of field points exceeds this limit, the remaining points will be omitted from the normalized gain. The gain may be normalized to its maximum or to a value input in field F6. The type of gain that is normalized is determined by the value of N as follows:
- N = 0 no normalized gain.
 = 1 major axis gain normalized.
 = 2 minor axis gain normalized.
 = 3 vertical axis gain normalized.
 = 4 horizontal axis gain normalized.
 = 5 total gain normalized.
- D - (column 19) selects either power gain or directive gain for both standard printing and normalization. If the structure excitation is an incident plane wave, the quantities printed under the heading "gain" will actually

be the scattering cross section (σ/λ^2) and will not be affected by the value of D. The column heading for the output will still read "power" or "directive gain," however.

D = 0 power gain.

D = 1 directive gain.

A - (column 20) requests calculation of average power gain over the region covered by field points.

A = 0 no averaging.

A = 1 average gain computed.

A = 2 average gain computed, printing of gain at the field points used for averaging is suppressed.

If NTH or NPH is equal to one, average gain will not be computed for any value of A since the area of the region covered by field points vanishes.

Floating Point Numbers

- THETS (F1) - Initial theta angle in degrees (initial z coordinate in meters if I1 = 1).
- PHIS (F2) - Initial phi angle in degrees.
- DTH (F3) - Increment for theta in degrees (increment for z in meters if I1 = 1).
- DPH (F4) - Increment for phi in degrees.
- RFLD (F5) - Radial distance (R) of field point from the origin in meters. RFLD is optional. If it is blank, the radiated electric field will have the factor $\exp(-jkR)/R$ omitted. If a value of R is specified, it should represent a point in the far-field region since near components of the field cannot be obtained with an RP card. (If I1 = 1, then RFLD represents the cylindrical coordinate ρ in meters and is not optional. It must be greater than about one wavelength.)
- GNOR (F6) - Determines the gain normalization factor if normalization has been requested in the I4 field. If GNOR is blank or zero, the gain will be normalized to its maximum value. If GNOR is not zero, the gain will be normalized to the value of GNOR.

Notes:

- The RP card will initiate program execution, causing the interaction matrix to be computed and factored and the structure currents to be computed if these operations have not already been performed. Hence, all required input parameters must be set before the RP card is read.
- At a single frequency, any number of RP cards may occur in sequence so that different field-point spacings may be used over different regions of space. If automatic frequency stepping is being used (i.e., NFRQ on the FR card is greater than one), only one RP card will act as data inside the loop. Subsequent cards will calculate patterns at the final frequency.
- When both NTH and NPH are greater than one, the angle theta (or Z) will be stepped faster than phi.
- When a ground plane has been specified, field points should not be requested below the ground (θ greater than 90 degrees or Z less than zero).

Transmission Line (TL)

Purpose: To generate a transmission line between any two points on the structure. Characteristic impedance, length, and shunt admittance are the defining parameters.

Card:

	2	5	10	15	20	30	40	50	60	70	80
TL	I1	I2	I3	I4	F1	F2	F3	F4	F5	F6	
The numbers along the top refer to the last column in each field.											

Parameters:

Integers - (the integer specifications are identical to those on the network (NT) card.)

Floating Point

(F1) - The characteristic impedance of the transmission line in ohms. A negative sign in front of the characteristic impedance will act as a flag for generating the transmission line with a 180° phase reversal (crossed line) if this is desired.

(F2) - The length of transmission line in meters. If this field is left blank, the program will use the straight line distance between the specified connection points.

The remaining four floating-point fields are used to specify the real and imaginary parts of the shunt admittances at end one and two, respectively.

(F3) - Real part of the shunt admittance in mhos at end one.

(F4) - Imaginary part of the shunt admittance in mhos at end one.

(F5) - Real part of the shunt admittance in mhos at end two

(F6) - Imaginary part of the shunt admittance in mhos at end two.

Notes:

- The rules for transmission line cards are the same as for network cards. All transmission line cards for a particular transmission line configuration must occur together with no other cards (except NT cards) separating them. When the first TL or NT card is read following a card other than a TL or NT card, all previous network or transmission line data are destroyed. Hence, if a set of TL cards is to be modified, all transmission line and network data must be input again in the modified form. Dimensions in the program limit the number of cards in a group that may be specified. In the NEC demonstration deck, the number of two-port networks (specified by NT cards and TL cards) is limited to thirty, and the number of different segments having network ports connected to them is limited to thirty.
- One or more networks (including transmission lines) may be connected to any given segment. Multiple network ports connected to one segment are connected in parallel.
- If a transmission line is connected to a segment that has been impedance loaded (i.e., through the use of an LD card), the load acts in series with the line.
- Use of transmission line cards (TL) after any form of execute requires the recalculation of the current only, and does not require recalculation of the matrix.
- NT and TL cards do not affect symmetry.

Write NGF File (WG)

Purpose: To write a NGF file for a structure on the file TAPE20.

Card:

	2	5	10	15	20	30	40	50	60	70	80
WG	blank	blank	blank	blank	blank	blank	blank	blank	blank	blank	blank

The numbers along the top refer to the last column in each field.

Parameters: None

Notes:

- See section III-5.

Execute (XQ)

Purpose: To cause program execution at points in the data stream where execution is not automatic. Options on the card also allow for automatic generation of radiation patterns in either of two vertical cuts.

Card:

2	5	10	15	20	30	40	50	60	70	80
XQ	11	blank	blank	blank	blank	blank	blank	blank	blank	blank
The numbers along the top refer to the last column in each field.										

Parameters:Integers

(11) — Options controlled by (11) are:

- 0 — no patterns requested (normal case).
- 1 — generates a pattern cut in the XZ plane, i.e., $\phi = 0^\circ$ and θ varies from 0° to 90° in 1° steps.
- 2 — generates a pattern cut in the YZ plane, i.e., $\phi = 90^\circ$ and θ varies from 0° to 90° in 1° steps.
- 3 — generates both of the cuts described for the values 1 and 2.

The remainder of the card is blank.

Notes:

- For the case of a single frequency step, four cards will automatically produce program execution (i.e., the program stops reading data and proceeds with the calculations requested to that point); the four cards are the execute card (XQ), the near-field cards (NE,NH), and the radiation-pattern card (RP). Thus, the only time the XQ card is mandatory, for the case of one frequency, is when only currents and impedances for the structure are desired. On the other hand, for the case of automatic frequency stepping, only the XQ card and the RP

card cause execution. Thus, if only near-fields or currents are desired, the XQ card is mandatory to cause execution. Furthermore, the XQ card can always be used as a divider in the data after a card which produces an execute. For instance, if the user wished to put a blank XQ card after an RP card to more easily divide the data into execution groups, the XQ card will act as a do-nothing card.

- The radiation-pattern generation option of the XQ card must not be used when a radial wire ground screen or a second medium has been specified. For these cases, the RP card is used where the presence of the additional ground parameters is indicated.

4. SOMNEC INPUT FOR SOMMERFELD/NORTON GROUND METHOD

When the Sommerfeld/Norton ground option is requested on the GN card, NEC reads interpolation tables from the file TAPE21. This file must be created prior to the NEC run by running the separate program SOMNEC. SOMNEC reads a single data card with the parameters:

EPR, SIG, FMHZ, IPT (format 3E10.3, I5)

The three decimal numbers end in columns 10, 20, and 30 and the integer IPT must end in column 35. The parameters are:

EPR = relative dielectric constant of ground (ϵ_r)

SIG = conductivity of ground in mhos/m (σ)

FMHZ = frequency in MHz

IPT = 1 to print the interpolation tables

= 0 for no printed output.

The interpolation tables depend only on the complex dielectric constant

$$\epsilon_c = \epsilon_r - j \frac{\sigma}{\omega \epsilon_0} ,$$

$$\epsilon_r = \text{EPR} , \quad \sigma = \text{SIG} .$$

If SIG is input as a negative number, the program sets

$$\epsilon_c = \text{EPR} - j |\text{SIG}| ,$$

and frequency is not used. The tables are written on the file TAPE21. The central processor time to generate the tables on a CDC 7600 computer is about 15 seconds.

5. THE NUMERICAL GREEN'S FUNCTION OPTION

With the Numerical Green's Function (NGF) option, a fixed structure and its environment may be modeled and the factored interaction matrix saved on a file. New parts may then be added to the model in subsequent computer runs and the complete solution obtained without repeating calculations for the data on the file. The main purpose of the NGF is to avoid unnecessary repetition of calculations when a part of a model, such as a single antenna in a complex environment, will be modified one or more times while the environment remains fixed. For example, when modeling antennas on ships,

several antenna designs or locations may be considered on an otherwise unchanged ship. With the NGF, the self-interaction matrix for the fixed environment may be computed, factored for solution, and saved on a tape or disk file. Solution for a new antenna then requires only the evaluation of the self-interaction matrix for the antenna, the mutual antenna-to-environment interactions, and matrix manipulations for a partitioned-matrix solution. When the previously written NGF file is used, the free space Green's function in the NEC formulation is, in effect, replaced by the Green's function for the environment.

Another reason for using the NGF option is to exploit partial symmetry in a structure. In a single run, a structure must be perfectly symmetric for NEC to use symmetry in the solution. Any unsymmetric segments or patches, or ones that lie in a symmetry plane or on the axis of rotation, will destroy the symmetry. Such partial symmetry may be exploited to reduce solution time by running the symmetric part of the model first and writing a NGF file. The unsymmetric parts may then be added in a second run.

Use of the NGF option may also be warranted for large, time-consuming models to save an expensive result for further use. Without adding new antennas, it may be used with a new excitation or to compute new radiation, near-field, or coupling data not computed in the original run.

To write a NGF file for a structure, the data deck is constructed as for a normal run. After the GE card, the frequency, ground parameters, and loading may be set by FR, GN, and LD cards. EK or KH may also be used. Other cards, such as EX or NT that do not change the matrix, will not affect the NGF and will not be saved on the file. After the model has been defined, a WG card is used to fill and factor the matrix and cause the NGF data to be written to the file TAPE20. TAPE20 should be saved after the run terminates. Other cards may follow the WG card to define an excitation and request field calculations as in a normal run. WG should be the first card to request filling and factoring of the matrix, however, since it reserves array space for the matrix in subsequent runs when the NGF is used. Hence, WG should come before XQ, RP, NE, or NH. The FR card must not specify multiple frequencies when a NGF is written.

To use a previously generated NGF file, the file is made available to the program as TAPE20. The first structure-geometry data card, following the CE card, must be a GF card to cause the program to read TAPE20. Subsequent

structure data cards define the new structure to be added to the NGF structure. All types of structure geometry data cards may be used although GM, CR, GX, and GS will affect new structure but not that from the NGF file. GR and GX will have their usual effect on the new structure but will not result in use of symmetry in the solution. Symmetry may be used in writing the NGF file but not for new structure used with the NGF.

For connections between the new structure and NGF structure, the new segment ends or patch centers are made to coincide with the NGF segment ends or patch centers as in a normal run. The rules still apply that only a single segment may connect to a given patch and a segment may have a patch connection on only one of its ends. Also, a wire may never connect to a patch formed by subdividing another patch for a previous connection.

Following the GE card the program control cards may be used as usual, with the exception that FR and GN cards may not be used. The parameters from these cards are taken from the NGF file and cannot be changed. LD cards may be used to load new segments but not segments in the NGF. If integers I3 and I4 on a LD card are blank, the card will load all new segments (new segments with tag LDTAG if I2 is not zero) but not NGF segments. If I2, I3 and I4 select a specific NGF segment, the run will terminate with an error message. The effect of loading on NGF segments may be obtained with a NT card, since NT (and TL) may connect to either new or NGF segments.

Computation time for a run using a NGF file may be estimated from the formulas in section V by evaluating the time to run the complete structure and subtracting time to fill and factor the matrix for the NGF part of the structure alone (T_1 and T_2). If the new structure connects to the NGF structure, new unknowns — in addition to those for the new segments and patches — are produced and should be included in the time estimate for the complete structure. If a new segment or patch connects to a NGF segment, the current expansion function for the NGF segment is modified. One new unknown is then added to the matrix equation to represent the modified expansion function and suppress the old expansion function. If a new segment connects to a NGF patch, 10 new unknowns are produced in addition to that for the new segment. Four new patches are automatically generated at the connection point accounting for eight unknowns. The remaining two new unknowns are needed to suppress the current on the old patch that has been replaced.

Although connection to a NGF segment modifies the old basis function, the current on the segment will be printed in its normal location in the table of segment currents. When a new wire connects to a NGF patch, the patch is divided into four new patches that will appear after the user-defined patches in the patch data. The original patch will be listed in the tables but with nearly zero current. Also, the Z coordinate of the original patch will be set to 9999.

Section IV NEC Output

Typical NEC output is illustrated in this section with examples that exercise most of the options available. In addition to demonstrating the use of the code and typical output, the results may be used to check the operation of the code when it is put in use on a new computer system. Most of the output is self-explanatory. The general form is outlined below, the particular points are discussed with the examples in which they occur.

The output follows the form of the input data, starting with the descriptive comments, followed by geometry data and then requested computations. Under the heading "STRUCTURE SPECIFICATION" is a list of the geometry data cards. The heading on the table is for a GW card, giving the X, Y, and Z coordinates of the wire ends, the radius, and the number of segments. Under the heading "WIRE NO." is a count of the number of GW cards. Data from other geometry cards are printed in the table with a label identifying the card. For a patch, the patch number is printed under "WIRE NO." followed by a letter to indicate the shape option — P for arbitrary, R for rectangular, T for triangular, and Q for quadrilateral.

After a GE card is read, a summary of the number of segments and patches is printed. The symmetry flag is zero for no symmetry, positive for planar symmetry, and negative for rotational symmetry. A table of multiple-wire junctions lists all junctions at which three or more wires join. The number of each connected segment is printed preceded by a minus sign if the current reference direction is out of the junction.

Data for individual segments are printed under "SEGMENTATION DATA," including angles, α and β , which are defined the same as for the patch normal vector (see figure 5). The connection data show the connection condition at each segment. "I-" is the number of the segment connected to the first end of segment I. If more than one segment connects to this junction, then I- will be the first connected segment following I in the sequence of segments. The numbers under "I+" give the same information for the second end of segment I. If the connection number is positive, the reference directions of the connected segments are parallel. If the number is negative, they are opposed (first end to first end, or second end to second end). A zero indicates a free wire end, while if I± is equal to I, that end of segment I is connected

to a ground plane. If I_{\pm} is greater than 10,000, the end is connected to a surface and $(I_{\pm}) - 10,000$ is the number of the first of the four patches around the connection point.

When patches are used, the next section is "SURFACE PATCH DATA." This includes the coordinates of the patch center, components of the unit normal vector, and patch area. Components of the unit tangent vectors, \hat{t}_1 and \hat{t}_2 , (see Section II) are also printed for use in reading the surface currents printed later.

The data cards following the geometry cards are printed exactly as they are read by the program. When a card requesting computations is encountered, information on ground parameters and loading is printed, followed by currents. The line "APPROXIMATE INTEGRATION..." gives the separation distance, set by a KH card, at which the Hertzian dipole approximation is used for the electric field due to a segment. If the extended thin-wire kernel has been requested by an EK card, this is also noted at this point in the output. Under "MATRIX TIMING" is printed the time to fill and factor the interaction matrix.

If one or more voltage sources have been specified, the voltage, current, impedance, admittance and input power are printed for each driving point. If the voltage source is the current-slope-discontinuity type, this is noted by "*" after the tag number in the input parameters table (see example 2). The antenna input parameters are followed by a table giving the current at the center of each segment. This table includes the coordinates at the segment centers and segment lengths in units of wavelength. If the model includes patches, a table of patch currents is printed giving the surface current in components along the tangent vectors \hat{t}_1 and \hat{t}_2 and in X, Y, and Z components.

If there are voltage sources on a model, a power budget is printed following the current tables. The input power here is the total power supplied by all voltage sources. The structure loss is ohmic loss in wires, while the network loss is the total power into all network and transmission line ports, assuming no radiation from networks or transmission lines. Finally, the radiated power is computed as input power minus structure and network loss.

Radiated fields or near-fields requested in the input data are printed following the current tables. In the normal radiation-pattern format, transmitting antenna gains are printed in dB in the components requested on

the RP card. If an incident-field excitation is used, rather than a voltage source, the gain columns will contain the bistatic scattering cross section (σ/λ^2). For very small gains, the number -999.99 is printed.

The radiation-pattern format also includes the radiated electric field in θ and ϕ components. These are labeled with the units "volts/m" for $E(R, \theta, \phi)$. Unless the range, R , is specified on the RP card, however, the quantity printed is the limit of $RE(R, \theta, \phi)$ as R approaches infinity, having units of volts. The polarization is printed in a format for general elliptic polarization, including axial ratio (minor axis/major axis), tilt angle of the major axis (η in figure 14), and sense of rotation (right-hand, left-hand, or linear).

In addition to these basic formats, there are a number of special formats for optional calculations. Many of these occur in the following examples.

EXAMPLES 1 THROUGH 4

Examples 1 through 4 are simple cases intended to illustrate the basic formats. Example 1 includes a calculation of near-electric-field along the wire. When the field is computed at the center of a segment without an applied field or loading, the Z-component of electric field is small since the solution procedure enforces the boundary condition at these points. This is a check that the program is operating correctly. The values would be still smaller if the field points were more precisely at the segment centers. The radial, or X, components of the near-field can also be compared with the charge densities at the segment centers ($\rho = 2\pi a \epsilon_0 E_x$). If the fields were computed along the wire axis, the radial field would be set to zero. For a nonplanar structure, however, computation along the axis is the only way to reproduce the conditions of the current solution and obtain small fields at the match points.

In example 2 the wire has an even number of segments so that a charge-discontinuity voltage source can be used at the center. The symbol "*" in the table of antenna input parameters is a reminder that this type of source has been used. Three frequencies are run for this case and the EX card option is used to collect and normalize the input impedances. At the end of example 2 the wire is given the conductivity of aluminum. This has a significant effect since the wire is relatively thin.

Example 3 is a vertical dipole over ground. Since the wire is thick, the extended thin-wire approximation has been used. Computation of the average power gain is requested on the RP cards. Over a perfectly conducting ground the average power gain should be 2. The computed result differs by about 1.5%, probably due to the 10-degree steps used in integrating the radiated power. For a more complex structure, the average gain can provide a check on the accuracy of the computed input impedance over a perfect ground where it should equal 2 or in free space where it should equal 1. Example 3 also includes a finitely conducting ground where the average gain of 0.72 indicates that only 36% of the power leaving the antenna is going into the space wave. The formats for normalized gain and the combined space-wave and ground-wave fields are illustrated. At the end of example 3, the wire is excited with an incident wave at 10-degree angles and the PT card option is used to print receiving antenna patterns.

Example 4 includes both patches and wires. Although the structure is over a perfect ground, the average power gain is 1.8. This indicates that the input impedance is inaccurate, probably due to the crude patch model used for the box. Since there is no ohmic loss, a more accurate input resistance can be obtained as

$$\begin{aligned} \text{Radiated power} &= 1/2 (\text{avg. gain}) \times (\text{computed input power}) \\ &= 1.016 (10^{-3}) \text{ W} \end{aligned}$$

$$\begin{aligned} \text{Radiation resistance} &= 2 (\text{radiated power}) / |I_{\text{source}}|^2 \\ &= 162.6 \text{ ohms.} \end{aligned}$$

Since the input power used in computing the gains in the radiation pattern table is too large by 0.46 dB, the gains can be corrected by adding this factor.

Examples 1 through 4 Input

```

CEEXAMPLE 1. CENTER FED LINEAR ANTENNA
GW 7 0. 0. -.25 0. 0. .25 .001
GE
EX 0 0 4 0 1.
XQ
LD 0 0 4 4 10. 3.000E-09 5.300E-11
PQ
NE 0 1 1 15 .001 0. 0. 0. 0. .01786
NX
CEEXAMPLE 2. CENTER FED LINEAR ANTENNA.
CURRENT SLOPE DISCONTINUITY SOURCE.
CM 1. THIN PERFECTLY CONDUCTING WIRE
CM 2. THIN ALUMINUM WIRE
GW 0 8 0. 0. -.25 0. 0. .25 .00001
GE
FR 0 3 0 0 200. 50.
EX 5 0 5 1 1. 0. 50.
XQ
LD 5 0 0 0 3.720E+07
FR 0 1 0 0 300.
EX 5 0 5 0 1.
XQ
NX
CEEXAMPLE 3. VERTICAL HALF WAVELENGTH ANTENNA OVER GROUND
EXTENDED THIN WIRE KERNEL USED
CM 1. PERFECT GROUND
CM 2. IMPERFECT GROUND INCLUDING GROUND WAVE AND RECEIVING
CE PATTERN CALCULATIONS
GW 9 0. 0. 2. 0. 0. 7. .3
GE 1
EK
FR 1 30.
EX 0 0 5 0 1.
GN 1
RP 0 10 2 1301 0. 0. 10. 90.
GN 5. 1.000E-03
RP 0 10 2 1301 0. 0. 10. 90.
RP 1 10 1 1. 0. 2. 0. 1.000E+05
EX 1 10 1 0. 0. 0. 10.
PT 2 0 5 5
XQ
NX
CEEXAMPLE 4. T ANTENNA ON A BOX OVER PERFECT GROUND
SP .1 .05 .05 0 0. .01
SP .05 .1 .05 0. 90. .01
GX 110
SP 0. 0. .1 90. 0. .04
GW 1 4 0. 0. .1 0. 0. .3 .001
GW 2 2 0. 0. .3 .15 0. .3 .001
GW 3 2 0. 0. .3 -.15 0. .3 .001
CE 1
GN 1
EX 1 1 1.
RP 10 4 1001 0. 0. 10. 30.
EN

```

Examples 1 through 4 Output

 NUMERICAL ELECTROMAGNETICS CODE

- - - COMMENTS - - -

EXAMPLE 1. CENTER FED LINEAR ANTENNA

- - - STRUCTURE SPECIFICATION - - -

COORDINATES MUST BE INPUT IN
 METERS OR BE SCALED TO METERS
 BEFORE STRUCTURE INPUT IS ENDED

WIRE NO.	X1	Y1	Z1	X2	Y2	Z2	RADIUS	NO. OF SEG.	FIRST SEG.	LAST SEG.	TAG NO.
1	0.	0.	-0.25000	0.	0.	0.25000	0.00100	7	1	7	-0

TOTAL SEGMENTS USED= 7 NO. SEG. IN A SYMMETRIC CELL= 7 SYMMETRY FLAG= 0

- MULTIPLE WIRE JUNCTIONS -
 JUNCTION SEGMENTS (- FOR END 1, + FOR END 2)
 NONE

- - - SEGMENTATION DATA - - -

COORDINATES IN METERS

[+ AND (- INDICATE THE SEGMENTS BEFORE AND AFTER]

SEG. NO.	COORDINATES OF		SEG. CENTER	SEG. LENGTH	ORIENTATION ANGLES		WIRE RADIUS	CONNECTION DATA			TAG NO.
	X	Y	Z		ALPHA	BETA		(-		+	
1	0.	0.	-0.21429	0.07143	90.00000	0.	0.00100	0	1	2	-0
2	0.	0.	-0.14286	0.07143	90.00000	0.	0.00100	1	2	3	-0
3	0.	0.	-0.07143	0.07143	90.00000	0.	0.00100	2	3	4	-0
4	0.	0.	0.00000	0.07143	90.00000	0.	0.00100	3	4	5	-0
5	0.	0.	0.07143	0.07143	90.00000	0.	0.00100	4	5	6	-0
6	0.	0.	0.14286	0.07143	90.00000	0.	0.00100	5	6	7	-0
7	0.	0.	0.21429	0.07143	90.00000	0.	0.00100	6	7	0	-0

***** DATA CARD NO.	1	EX	0	0	4	0	1.00000E+00	0.	0.	0.	0.
***** DATA CARD NO.	2	XQ	-0	-0	-0	-0	0.	0.	0.	0.	0.

- - - - - FREQUENCY - - - - -

FREQUENCY= 2.9980E+02 MHZ
 WAVELENGTH= 1.0000E+00 METERS

APPROXIMATE INTEGRATION EMPLOYED FOR SEGMENTS MORE THAN 1.000 WAVELENGTHS APART

- - - STRUCTURE IMPEDANCE LOADING - - -

THIS STRUCTURE IS NOT LOADED

- - - ANTENNA ENVIRONMENT - - -
FREE SPACE

- - - MATRIX TIMING - - -

FILL# 0.021 SEC., FACTOR# 0.001 SEC.

- - - ANTENNA INPUT PARAMETERS - - -

TAG NO.	SEG. NO.	VOLTAGE (VOLTS)		CURRENT (AMPS)		IMPEDANCE (OHMS)		ADMITTANCE (MHOS)		POWER (WATTS)
		REAL	IMAG.	REAL	IMAG.	REAL	IMAG.	REAL	IMAG.	
-0	4	1.00000E+00	0.	9.20585E-03	-5.15474E-03	8.26979E+01	4.63060E+01	9.20585E-03	-5.15474E-03	4.60292E-03

- - - CURRENTS AND LOCATION - - -

DISTANCES IN WAVELENGTHS

SEG. NO.	TAG NO.	COORD. OF SEG. CENTER			SEG. LENGTH	CURRENT (AMPS)			PHASE
		X	Y	Z		REAL	IMAG.	MAG.	
1	-0	0.	0.	-0.2143	0.07143	2.3592E-03	-1.6881E-03	2.9010E-03	-35.584
2	-0	0.	0.	-0.1429	0.07143	5.9998E-03	-4.0463E-03	7.2367E-03	-33.996
3	-0	0.	0.	-0.0714	0.07143	8.3711E-03	-5.1857E-03	9.8472E-03	-31.777
4	-0	0.	0.	0.0000	0.07143	9.2058E-03	-5.1547E-03	1.0551E-02	-29.246
5	-0	0.	0.	0.0714	0.07143	8.3711E-03	-5.1857E-03	9.8472E-03	-31.777
6	-0	0.	0.	0.1429	0.07143	5.9998E-03	-4.0463E-03	7.2367E-03	-33.996
7	-0	0.	0.	0.2143	0.07143	2.3592E-03	-1.6881E-03	2.9010E-03	-35.584

- - - POWER BUDGET - - -

INPUT POWER = 4.6029E-03 WATTS
 RADIATED POWER = 4.6029E-03 WATTS
 STRUCTURE LOSS = 0. WATTS
 NETWORK LOSS = 0. WATTS
 EFFICIENCY = 100.00 PERCENT

***** DATA CARD NO.	3	LD	0	0	4	4	1.00000E+01	3.00000E-09	5.30000E-11	0.	0.	0.
***** DATA CARD NO.	4	PQ	-0	-0	-0	-0	0.	0.	0.	0.	0.	0.
***** DATA CARD NO.	5	NE	0	1	1	15	1.00000E-03	0.	0.	0.	0.	1.78600E-01

- - - STRUCTURE IMPEDANCE LOADING - - -

LOCATION (TAG FROM THRU)			RESISTANCE	INDUCTANCE	CAPACITANCE	IMPEDANCE (OHMS)		CONDUCTIVITY	TYPE
			OHMS	HENRYS	FARADS	REAL	IMAGINARY	MHOS/METER	
4	4		1.0000E+01	3.0000E-09	5.3000E-11				SERIES

- - - ANTENNA ENVIRONMENT - - -
FREE SPACE

- - - MATRIX TIMING - - -

FILL# 0.021 SEC., FACTOR# 0.001 SEC.

- - - ANTENNA INPUT PARAMETERS - - -

TAG NO.	SEG. NO.	VOLTAGE (VOLTS)		CURRENT (AMPS)		IMPEDANCE (OHMS)		ADMITTANCE (MHOS)		POWER (WATTS)
		REAL	IMAG.	REAL	IMAG.	REAL	IMAG.	REAL	IMAG.	
-0	4	1.00000E+00	0.	8.95465E-03	-4.05149E-03	9.26979E+01	4.19407E+01	8.95465E-03	-4.05149E-03	4.47735E-03

- - - CURRENTS AND LOCATION - - -

DISTANCES IN WAVELENGTHS

SEG. NO.	TAG NO.	COORD. OF SEG. CENTER			SEG. LENGTH	CURRENT (AMPS)			PHASE
		X	Y	Z		REAL	IMAG.	MAG.	
1	-0	0.	0.	-0.2143	0.07143	2.3241E-03	-1.3790E-03	2.7024E-03	-30.682
2	-0	0.	0.	-0.1429	0.07143	5.8908E-03	-3.2779E-03	6.7413E-03	-29.093
3	-0	0.	0.	-0.0714	0.07143	8.1824E-03	-4.1467E-03	9.1731E-03	-26.875
4	-0	0.	0.	0.0000	0.07143	8.9547E-03	-4.0515E-03	9.8285E-03	-24.344
5	-0	0.	0.	0.0714	0.07143	8.1824E-03	-4.1467E-03	9.1731E-03	-26.875
6	-0	0.	0.	0.1429	0.07143	5.8908E-03	-3.2779E-03	6.7413E-03	-29.093
7	-0	0.	0.	0.2143	0.07143	2.3241E-03	-1.3790E-03	2.7024E-03	-30.682

- - - CHARGE DENSITIES - - -

DISTANCES IN WAVELENGTHS

SEG. NO.	TAG NO.	COORD. OF SEG. CENTER			SEG. LENGTH	CHARGE DENSITY (COULOMBS/METER)			PHASE
		X	Y	Z		REAL	IMAG.	MAG.	
1	-0	0.	0.	-0.2143	0.07143	1.8292E-11	3.1761E-11	3.6652E-11	60.061
2	-0	0.	0.	-0.1429	0.07143	1.0429E-11	2.2040E-11	2.4383E-11	64.676
3	-0	0.	0.	-0.0714	0.07143	2.1140E-12	1.1638E-11	1.1829E-11	79.705
4	-0	0.	0.	0.0000	0.07143	5.1684E-19	2.3814E-19	5.6906E-19	24.738
5	-0	0.	0.	0.0714	0.07143	-2.1140E-12	-1.1638E-11	1.1829E-11	-100.295
6	-0	0.	0.	0.1429	0.07143	-1.0429E-11	-2.2040E-11	2.4383E-11	-115.324
7	-0	0.	0.	0.2143	0.07143	-1.8292E-11	-3.1761E-11	3.6652E-11	-119.939

- - - POWER BUDGET - - -

INPUT POWER = 4.4773E-03 WATTS
 RADIATED POWER = 3.9943E-03 WATTS
 STRUCTURE LOSS = 4.8300E-04 WATTS
 NETWORK LOSS = 0 WATTS
 EFFICIENCY = 89.21 PERCENT

- - - NEAR ELECTRIC FIELDS - - -

LOCATION			EX		EY		EZ	
X	Y	Z	MAGNITUDE	PHASE	MAGNITUDE	PHASE	MAGNITUDE	PHASE
METERS	METERS	METERS	VOLTS/M	DEGREES	VOLTS/M	DEGREES	VOLTS/M	DEGREES
0.0010	0.	0.	1.0228E-05	24.74	0.	0.	1.3042E+01	-175.10
0.0010	0.	0.0179	5.5442E+01	-66.31	0.	0.	1.2537E+01	-175.08
0.0010	0.	0.0357	1.0968E+02	-67.15	0.	0.	6.7271E+00	-175.46
0.0010	0.	0.0536	1.5608E+02	-88.85	0.	0.	8.4339E-01	-179.75
0.0010	0.	0.0714	2.1267E+02	-100.30	0.	0.	4.2135E-04	-6.13
0.0010	0.	0.0893	2.7147E+02	-106.86	0.	0.	3.4497E-01	-8.87
0.0010	0.	0.1072	3.2920E+02	-111.08	0.	0.	2.8000E-01	22.83
0.0010	0.	0.1250	3.8592E+02	-113.51	0.	0.	2.2076E-01	74.41
0.0010	0.	0.1429	4.3835E+02	-115.33	0.	0.	3.0905E-04	-94.14
0.0010	0.	0.1607	4.8563E+02	-116.77	0.	0.	2.1937E-01	-106.41
0.0010	0.	0.1786	5.2800E+02	-117.97	0.	0.	1.9750E+00	57.57
0.0010	0.	0.1965	5.9664E+02	-119.06	0.	0.	3.3113E+00	58.63
0.0010	0.	0.2143	6.5880E+02	-119.94	0.	0.	9.9556E-03	-121.24
0.0010	0.	0.2322	7.1246E+02	-120.67	0.	0.	1.0680E+01	-121.66
0.0010	0.	0.2500	5.5195E+02	-121.29	0.	0.	3.8032E+02	-121.43

***** DATA CARD NO. 6 NX -0 -0 -0 -0 0. 0. 0. 0. 0. 0.

NUMERICAL ELECTROMAGNETICS CODE

COMMENTS

EXAMPLE 2. CENTER FED LINEAR ANTENNA.
CURRENT SLOPE DISCONTINUITY SOURCE.
1. THIN PERFECTLY CONDUCTING WIRE
2. THIN ALUMINUM WIRE

STRUCTURE SPECIFICATION

COORDINATES MUST BE INPUT IN METERS OR BE SCALED TO METERS BEFORE STRUCTURE INPUT IS ENDED

WIRE NO.	X1	Y1	Z1	X2	Y2	Z2	RADIUS	NO. OF SEG.	FIRST SEG.	LAST SEG.	TAG NO.
1	0.	0.	-0.25000	0.	0.	0.25000	0.00001	8	1	8	0

TOTAL SEGMENTS USED= 8 NO. SEG. IN A SYMMETRIC CELL= 8 SYMMETRY FLAG= 0

MULTIPLE WIRE JUNCTIONS -
JUNCTION SEGMENTS (- FOR END 1, + FOR END 2)
NONE

SEGMENTATION DATA

COORDINATES IN METERS

I+ AND I- INDICATE THE SEGMENTS BEFORE AND AFTER I

SEG. NO.	COORDINATES OF		SEG. CENTER Z	SEG. LENGTH	ORIENTATION ANGLES		WIRE RADIUS	CONNECTION DATA			TAG NO.
	X	Y			ALPHA	BETA		I-	I	I+	
1	0.	0.	-0.21875	0.06250	90.00000	0.	0.00001	0	1	2	0
2	0.	0.	-0.15625	0.06250	90.00000	0.	0.00001	1	2	3	0
3	0.	0.	-0.09375	0.06250	90.00000	0.	0.00001	2	3	4	0
4	0.	0.	-0.03125	0.06250	90.00000	0.	0.00001	3	4	5	0
5	0.	0.	0.03125	0.06250	90.00000	0.	0.00001	4	5	6	0
6	0.	0.	0.09375	0.06250	90.00000	0.	0.00001	5	6	7	0
7	0.	0.	0.15625	0.06250	90.00000	0.	0.00001	6	7	8	0
8	0.	0.	0.21875	0.06250	90.00000	0.	0.00001	7	8	0	0

***** DATA CARD NO. 1 FR 0 3 0 0 2.00000E+02 5.00000E+01 0. 0. 0.
***** DATA CARD NO. 2 EX 5 0 5 1 1.00000E+00 0. 5.00000E+01 0. 0. 0.
***** DATA CARD NO. 3 XQ -0 -0 -0 -0 0 0. 0. 0. 0. 0. 0.

FREQUENCY

FREQUENCY= 2.0000E+02 MHZ
WAVELENGTH= 1.4990E+00 METERS

APPROXIMATE INTEGRATION EMPLOYED FOR SEGMENTS MORE THAN 1.000 WAVELENGTHS APART

STRUCTURE IMPEDANCE LOADING

THIS STRUCTURE IS NOT LOADED

- - - ANTENNA ENVIRONMENT - - -
FREE SPACE

- - - MATRIX TIMING - - -

FILL= 0.027 SEC., FACTOR= 0.002 SEC.

- - - ANTENNA INPUT PARAMETERS - - -

TAG NO.	SEG. NO.	VOLTAGE (VOLTS)		CURRENT (AMPS)		IMPEDANCE (OHMS)		ADMITTANCE (MHOS)		POWER (WATTS)
		REAL	IMAG.	REAL	IMAG.	REAL	IMAG.	REAL	IMAG.	
0	5	1.00000E+00	0.	6.64061E-05	1.57934E-03	2.65762E+01	-6.32060E+02	6.64061E-05	1.57934E-03	3.32031E-05

- - - CURRENTS AND LOCATION - - -

DISTANCES IN WAVELENGTHS

SEG. NO.	TAG NO.	COORD. OF SEG. CENTER			SEG. LENGTH	CURRENT (AMPS)			PHASE
		X	Y	Z		REAL	IMAG.	MAG.	
1	0	0.	0.	-0.1459	0.04169	1.5369E-05	2.5220E-04	2.5267E-04	86.513
2	0	0.	0.	-0.1042	0.04169	3.9856E-05	7.0589E-04	7.0702E-04	86.768
3	0	0.	0.	-0.0625	0.04169	5.6673E-05	1.1008E-03	1.1023E-03	87.053
4	0	0.	0.	-0.0208	0.04169	6.5314E-05	1.4319E-03	1.4334E-03	87.388
5	0	0.	0.	0.0208	0.04169	6.5314E-05	1.4319E-03	1.4334E-03	87.388
6	0	0.	0.	0.0625	0.04169	5.6673E-05	1.1008E-03	1.1023E-03	87.053
7	0	0.	0.	0.1042	0.04169	3.9856E-05	7.0589E-04	7.0702E-04	86.768
8	0	0.	0.	0.1459	0.04169	1.5369E-05	2.5220E-04	2.5267E-04	86.513

- - - POWER BUDGET - - -

INPUT POWER = 3.3203E-05 WATTS
RADIATED POWER= 3.3203E-05 WATTS
STRUCTURE LOSS= 0. WATTS
NETWORK LOSS = 0. WATTS
EFFICIENCY = 100.00 PERCENT

- - - - - FREQUENCY - - - - -

FREQUENCY= 2.5000E+02 MHZ
WAVELENGTH= 1.1992E+00 METERS

APPROXIMATE INTEGRATION EMPLOYED FOR SEGMENTS MORE THAN 1.000 WAVELENGTHS APART

- - - STRUCTURE IMPEDANCE LOADING - - -

THIS STRUCTURE IS NOT LOADED

- - - ANTENNA ENVIRONMENT - - -
FREE SPACE

- - - MATRIX TIMING - - -

FILL= 0.027 SEC., FACTOR= 0.002 SEC.

- - - ANTENNA INPUT PARAMETERS - - -

TAG NO.	SEG. NO.	VOLTAGE (VOLTS)		CURRENT (AMPS)		IMPEDANCE (OHMS)		ADMITTANCE (MHOS)		POWER (WATTS)	
		REAL	IMAG.	REAL	IMAG.	REAL	IMAG.	REAL	IMAG.		
0	*	5	1.00000E+00	0.	6.16984E-04	3.56466E-03	4.71431E+01	-2.72372E+02	6.16984E-04	3.56466E-03	3.08492E-04

- - - CURRENTS AND LOCATION - - -

DISTANCES IN WAVELENGTHS

SEG. NO.	TAG NO.	COORD. OF SEG. CENTER			SEG. LENGTH	CURRENT (AMPS)			PHASE
		X	Y	Z		REAL	IMAG.	MAG.	
1	0	0.	0.	-0.1824	0.05212	1.3629E-04	6.4701E-04	6.6120E-04	78.105
2	0	0.	0.	-0.1303	0.05212	3.6169E-04	1.7863E-03	1.8225E-03	78.553
3	0	0.	0.	-0.0782	0.05212	5.2215E-04	2.7057E-03	2.7557E-03	79.077
4	0	0.	0.	-0.0261	0.05212	6.0627E-04	3.3503E-03	3.4047E-03	79.743
5	0	0.	0.	0.0261	0.05212	6.0627E-04	3.3503E-03	3.4047E-03	79.743
6	0	0.	0.	0.0782	0.05212	5.2215E-04	2.7057E-03	2.7557E-03	79.077
7	0	0.	0.	0.1303	0.05212	3.6169E-04	1.7863E-03	1.8225E-03	78.553
8	0	0.	0.	0.1824	0.05212	1.3629E-04	6.4701E-04	6.6120E-04	78.105

- - - POWER BUDGET - - -

INPUT POWER = 3.0849E-04 WATTS
 RADIATED POWER = 3.0849E-04 WATTS
 STRUCTURE LOSS = 0. WATTS
 NETWORK LOSS = 0. WATTS
 EFFICIENCY = 100.00 PERCENT

- - - - - FREQUENCY - - - - -

FREQUENCY = 3.0000E+02 MHZ
 WAVELENGTH = 9.9933E-01 METERS

APPROXIMATE INTEGRATION EMPLOYED FOR SEGMENTS MORE THAN 1.000 WAVELENGTHS APART

- - - STRUCTURE IMPEDANCE LOADING - - -

THIS STRUCTURE IS NOT LOADED

- - - ANTENNA ENVIRONMENT - - -
FREE SPACE

- - - MATRIX TIMING - - -

FILL = 0.027 SEC., FACTOR = 0.002 SEC.

- - - ANTENNA INPUT PARAMETERS - - -

TAG NO.	SEG. NO.	VOLTAGE (VOLTS)		CURRENT (AMPS)		IMPEDANCE (OHMS)		ADMITTANCE (MHOS)		POWER (WATTS)	
		REAL	IMAG.	REAL	IMAG.	REAL	IMAG.	REAL	IMAG.		
0	*	5	1.00000E+00	0.	9.39012E-03	-5.32909E-03	8.05511E+01	4.57144E+01	9.39012E-03	-5.32909E-03	4.69506E-03

- - - CURRENTS AND LOCATION - - -

DISTANCES IN WAVELENGTHS

SEG. NO.	TAG NO.	COORD. OF SEG. CENTER			SEG. LENGTH	CURRENT (AMPS)			PHASE
		X	Y	Z		REAL	IMAG.	MAG.	
1	0	0.	0.	-0.2189	0.06254	1.9607E-03	-1.2799E-03	2.3415E-03	-33.135
2	0	0.	0.	-0.1564	0.06254	5.3517E-03	-3.4033E-03	6.3422E-03	-32.454
3	0	0.	0.	-0.0938	0.06254	7.8678E-03	-4.8421E-03	9.2384E-03	-31.610
4	0	0.	0.	-0.0313	0.06254	9.2168E-03	-5.4147E-03	1.0690E-02	-30.433
5	0	0.	0.	0.0313	0.06254	9.2168E-03	-5.4147E-03	1.0690E-02	-30.433
6	0	0.	0.	0.0938	0.06254	7.8678E-03	-4.8421E-03	9.2384E-03	-31.610
7	0	0.	0.	0.1564	0.06254	5.3517E-03	-3.4033E-03	6.3422E-03	-32.454
8	0	0.	0.	0.2189	0.06254	1.9607E-03	-1.2799E-03	2.3415E-03	-33.135

- - - POWER BUDGET - - -

INPUT POWER = 4.6951E-03 WATTS
 RADIATED POWER = 4.6951E-03 WATTS
 STRUCTURE LOSS = 0. WATTS
 NETWORK LOSS = 0. WATTS
 EFFICIENCY = 100.00 PERCENT

- - - INPUT IMPEDANCE DATA - - -

SOURCE SEGMENT NO. 5
 NORMALIZATION FACTOR = 5.0000E+01

FREQ. MHZ	UNNORMALIZED IMPEDANCE				NORMALIZED IMPEDANCE			
	RESISTANCE OHMS	REACTANCE OHMS	MAGNITUDE OHMS	PHASE DEGREES	RESISTANCE	REACTANCE	MAGNITUDE	PHASE DEGREES
200.000	2.65762E+01	-6.32060E+02	6.32619E+02	-87.59	5.31523E-01	-1.26412E+01	1.26524E+01	-87.59
250.000	4.71431E+01	-2.72372E+02	2.76422E+02	-80.18	9.42862E-01	-5.44744E+00	5.52843E+00	-80.18
300.000	8.05511E+01	4.57144E+01	9.26190E+01	29.58	1.61102E+00	9.14289E-01	1.85238E+00	29.58

**** DATA CARD NO. 4	LD	5	0	0	0	3.72000E+07	0.	0.	0.	0.
**** DATA CARD NO. 5	FR	0	1	0	0	3.00000E+02	0.	0.	0.	0.
**** DATA CARD NO. 6	EX	5	0	5	0	1.00000E+00	0.	0.	0.	0.
**** DATA CARD NO. 7	XQ	-0	-0	-0	-0	0	0.	0.	0.	0.

- - - - - FREQUENCY - - - - -

FREQUENCY = 3.0000E+02 MHZ
 WAVELENGTH = 9.9933E-01 METERS

APPROXIMATE INTEGRATION EMPLOYED FOR SEGMENTS MORE THAN 1.000 WAVELENGTHS APART

- - - STRUCTURE IMPEDANCE LOADING - - -

LOCATION ITAG FROM THRU	RESISTANCE OHMS	INDUCTANCE HENRYS	CAPACITANCE FARADS	IMPEDANCE (OHMS)		CONDUCTIVITY MHOS/METER	TYPE
				REAL	IMAGINARY		
ALL						3.7200E+07	WIRE

- - - ANTENNA ENVIRONMENT - - -
 FREE SPACE

- - - MATRIX TIMING - - -

FILL= 0.027 SEC., FACTOR= 0.002 SEC.

- - - ANTENNA INPUT PARAMETERS - - -

TAG NO.	SEG. NO.	VOLTAGE (VOLTS)		CURRENT (AMPS)		IMPEDANCE (OHMS)		ADMITTANCE (MHOS)		POWER (WATTS)
		REAL	IMAG.	REAL	IMAG.	REAL	IMAG.	REAL	IMAG.	
0	5	1.00000E+00	0.	6.64431E-03	-3.86660E-03	1.12430E+02	6.54276E+01	6.64431E-03	-3.86660E-03	3.32215E-03

- - - CURRENTS AND LOCATION - - -

DISTANCES IN WAVELENGTHS

SEG. NO.	TAG NO.	COORD. OF SEG. CENTER			SEG. LENGTH	CURRENT (AMPS)			
		X	Y	Z		REAL	IMAG.	MAG.	PHASE
1	0	0.	0.	-0.2189	0.06254	1.3862E-03	-9.6305E-04	1.6879E-03	-34.790
2	0	0.	0.	-0.1564	0.06254	3.7848E-03	-2.5546E-03	4.5663E-03	-34.018
3	0	0.	0.	-0.0938	0.06254	5.5658E-03	-3.6091E-03	6.6336E-03	-32.961
4	0	0.	0.	-0.0313	0.06254	6.5215E-03	-3.9782E-03	7.6392E-03	-31.384
5	0	0.	0.	0.0313	0.06254	6.5215E-03	-3.9782E-03	7.6392E-03	-31.384
6	0	0.	0.	0.0938	0.06254	5.5658E-03	-3.6091E-03	6.6336E-03	-32.961
7	0	0.	0.	0.1564	0.06254	3.7848E-03	-2.5546E-03	4.5663E-03	-34.018
8	0	0.	0.	0.2189	0.06254	1.3862E-03	-9.6305E-04	1.6879E-03	-34.790

- - - POWER BUDGET - - -

INPUT POWER = 3.3222E-03 WATTS
 RADIATED POWER= 2.4402E-03 WATTS
 STRUCTURE LOSS= 8.8199E-04 WATTS
 NETWORK LOSS = 0. WATTS
 EFFICIENCY = 73.45 PERCENT

***** DATA CARD NO. 8 NX -0 -0 -0 -0 0. 0. 0. 0. 0.

.....
 NUMERICAL ELECTROMAGNETICS CODE

- - - - COMMENTS - - - -

EXAMPLE 3. VERTICAL HALF WAVELENGTH ANTENNA OVER GROUND
 EXTENDED THIN WIRE KERNEL USED
 1. PERFECT GROUND
 2. IMPERFECT GROUND INCLUDING GROUND WAVE AND RECEIVING
 PATTERN CALCULATIONS

- - - STRUCTURE SPECIFICATION - - -

COORDINATES MUST BE INPUT IN
 METERS OR BE SCALED TO METERS
 BEFORE STRUCTURE INPUT IS ENDED

WIRE NO.	X1	Y1	Z1	X2	Y2	Z2	RADIUS	NO. OF SEG.	FIRST SEG.	LAST SEG.	TAG NO.
1	0.	0.	2.00000	0.	0.	7.00000	0.30000	9	1	9	-0

GROUND PLANE SPECIFIED.

WHERE WIRE ENDS TOUCH GROUND, CURRENT WILL BE INTERPOLATED TO IMAGE IN GROUND PLANE.

TOTAL SEGMENTS USED= 9 NO. SEG. IN A SYMMETRIC CELL= 9 SYMMETRY FLAG= 0

- MULTIPLE WIRE JUNCTIONS -

JUNCTION SEGMENTS (- FOR END 1, + FOR END 2)
 NONE

- - - - SEGMENTATION DATA - - - -

COORDINATES IN METERS

[+ AND |- INDICATE THE SEGMENTS BEFORE AND AFTER]

SEG. NO.	COORDINATES OF	SEG. CENTER	SEG. LENGTH	ORIENTATION ANGLES	WIRE RADIUS	CONNECTION DATA	TAG NO.
	X Y Z			ALPHA BETA		[- +	
1	0. 0.	2.27778	0.55556	90.00000 0.	0.30000	0 1 2	-0
2	0. 0.	2.83333	0.55556	90.00000 0.	0.30000	1 2 3	-0
3	0. 0.	3.38889	0.55556	90.00000 0.	0.30000	2 3 4	-0
4	0. 0.	3.94444	0.55556	90.00000 0.	0.30000	3 4 5	-0
5	0. 0.	4.50000	0.55556	90.00000 0.	0.30000	4 5 6	-0
6	0. 0.	5.05556	0.55556	90.00000 0.	0.30000	5 6 7	-0
7	0. 0.	5.61111	0.55556	90.00000 0.	0.30000	6 7 8	-0
8	0. 0.	6.16667	0.55556	90.00000 0.	0.30000	7 8 9	-0
9	0. 0.	6.72222	0.55556	90.00000 0.	0.30000	8 9 0	-0

***** DATA CARD NO. 1	EK	-0	-0	-0	-0	0.	0.	0.	0.	0.
***** DATA CARD NO. 2	FR	-0	1	-0	-0	3.00000E+01	0.	0.	0.	0.
***** DATA CARD NO. 3	EX	0	0	5	0	1.00000E+00	0.	0.	0.	0.
***** DATA CARD NO. 4	GN	1	-0	-0	-0	0.	0.	0.	0.	0.
***** DATA CARD NO. 5	RP	0	10	2	1301	0.	0.	0.	0.	0.
							1.00000E+01	9.00000E+01	0.	0.

- - - - FREQUENCY - - - -

FREQUENCY= 3.0000E+01 MHZ
 WAVELENGTH= 9.9933E+00 METERS

APPROXIMATE INTEGRATION EMPLOYED FOR SEGMENTS MORE THAN 1.000 WAVELENGTHS APART
 THE EXTENDED THIN WIRE KERNEL WILL BE USED

- - - STRUCTURE IMPEDANCE LOADING - - -

THIS STRUCTURE IS NOT LOADED

- - - ANTENNA ENVIRONMENT - - -
 PERFECT GROUND

- - - MATRIX TIMING - - -

FILL= 0.049 SEC. FACTOR= 0.003 SEC.

- - - ANTENNA INPUT PARAMETERS - - -

TAG NO.	SEG. NO.	VOLTAGE (VOLTS)		CURRENT (AMPS)		IMPEDANCE (OHMS)		ADMITTANCE (MHOS)		POWER (WATTS)
		REAL	IMAG	REAL	IMAG.	REAL	IMAG.	REAL	IMAG.	
-0	5	1.00000E+00	0.	9.31462E-03	-8.66863E-04	1.06436E+02	9.90546E+00	9.31462E-03	-8.66863E-04	4.65731E-03

- - - CURRENTS AND LOCATION - - -

DISTANCES IN WAVELENGTHS

SEG. NO.	TAG NO.	COORD. OF SEG. CENTER			SEG. LENGTH	CURRENT (AMPS)			
		X	Y	Z		REAL	IMAG.	MAG.	PHASE
1	-0	0.	0.	0.2279	0.05559	2.8965E-03	-2.5964E-03	3.8099E-03	-41.873
2	-0	0.	0.	0.2835	0.05559	5.5162E-03	-4.2028E-03	6.9348E-03	-37.304
3	-0	0.	0.	0.3391	0.05559	7.4817E-03	-4.6585E-03	8.8135E-03	-31.909
4	-0	0.	0.	0.3947	0.05559	9.7867E-03	-3.7800E-03	9.5653E-03	-23.277
5	-0	0.	0.	0.4503	0.05559	9.3146E-03	-8.6686E-04	9.3549E-03	-5.317
6	-0	0.	0.	0.5059	0.05559	9.0040E-03	-3.8010E-03	9.7734E-03	-22.887
7	-0	0.	0.	0.5615	0.05559	7.8625E-03	-4.6896E-03	9.1549E-03	-30.814
8	-0	0.	0.	0.6171	0.05559	5.9562E-03	-4.2264E-03	7.3034E-03	-35.359
9	-0	0.	0.	0.6727	0.05559	3.2218E-03	-2.6004E-03	4.1403E-03	-38.908

- - - POWER BUDGET - - -

INPUT POWER = 4.6573E-03 WATTS
 RADIATED POWER= 4.6573E-03 WATTS
 STRUCTURE LOSS= 0. WATTS
 NETWORK LOSS = 0. WATTS
 EFFICIENCY = 100.00 PERCENT

- - - RADIATION PATTERNS - - -

- - ANGLES - -		- POWER GAINS -			- - - POLARIZATION - - -			- - - E(THETA) - - -		- - - E(IPHI) - - -	
THETA DEGREES	PHI DEGREES	VERT. DB	HOR. DB	TOTAL DB	AXIAL RATIO	TILT DEG.	SENSE	MAGNITUDE VOLTS/M	PHASE DEGREES	MAGNITUDE VOLTS/M	PHASE DEGREES
0.	0.	-999.99	-999.99	-999.99	0.	0.		0.	0.	0.	0.
10.00	0.	-9.87	-999.99	-9.87	0.	0.	LINEAR	1.69640E-01	-114.38	0.	0.
20.00	0.	-4.21	-999.99	-4.21	0.	0.	LINEAR	3.25650E-01	-114.64	0.	0.
30.00	0.	-1.70	-999.99	-1.70	0.	0.	LINEAR	4.34377E-01	-115.01	0.	0.
40.00	0.	-1.74	-999.99	-1.74	0.	0.	LINEAR	4.32394E-01	-115.37	0.	0.
50.00	0.	-6.73	-999.99	-6.73	0.	0.	LINEAR	2.43509E-01	-115.33	0.	0.
60.00	0.	-10.04	-999.99	-10.04	0.	0.	LINEAR	1.66301E-01	61.67	0.	0.
70.00	0.	2.67	-999.99	2.67	0.	0.	LINEAR	7.18953E-01	62.56	0.	0.
80.00	0.	7.20	-999.99	7.20	0.	0.	LINEAR	1.21101E+00	62.51	0.	0.
90.00	0.	8.52	-999.99	8.52	0.	0.	LINEAR	1.40967E+00	62.47	0.	0.
0.	90.00	-999.99	-999.99	-999.99	0.	0.		0.	0.	0.	0.
10.00	90.00	-9.87	-999.99	-9.87	0.	0.	LINEAR	1.69640E-01	-114.38	0.	0.
20.00	90.00	-4.21	-999.99	-4.21	0.	0.	LINEAR	3.25650E-01	-114.64	0.	0.
30.00	90.00	-1.70	-999.99	-1.70	0.	0.	LINEAR	4.34377E-01	-115.01	0.	0.
40.00	90.00	-1.74	-999.99	-1.74	0.	0.	LINEAR	4.32394E-01	-115.37	0.	0.
50.00	90.00	-6.73	-999.99	-6.73	0.	0.	LINEAR	2.43509E-01	-115.33	0.	0.

60.00	90.00	-10.04	-999.99	-10.04	0.	0.	LINEAR	1.66301E-01	61.67	0.	0.
70.00	90.00	2.67	-999.99	2.67	0.	0.	LINEAR	7.18953E-01	62.56	0.	0.
80.00	90.00	7.20	-999.99	7.20	0.	0.	LINEAR	1.21101E+00	62.51	0.	0.
90.00	90.00	8.52	-999.99	8.52	0	0.	LINEAR	1.40967E+00	62.47	0.	0.

AVERAGE POWER GAIN= 2.02794E+00 SOLID ANGLE USED IN AVERAGING=(0.5000)*PI STERADIANS.

--- NORMALIZED GAIN ---

VERTICAL GAIN
NORMALIZATION FACTOR = 8.52 DB

-- ANGLES --			-- ANGLES --			-- ANGLES --		
THETA	PHI	GAIN	THETA	PHI	GAIN	THETA	PHI	GAIN
DEGREES	DEGREES	DB	DEGREES	DEGREES	DB	DEGREES	DEGREES	DB
0.	0.	-1008.51	70.00	0.	-5.85	40.00	90.00	-10.27
10.00	0.	-18.39	80.00	0.	-1.32	50.00	90.00	-15.25
20.00	0.	-12.73	90.00	0.	0.	60.00	90.00	-18.56
30.00	0.	-10.23	0.	90.00	-1008.51	70.00	90.00	-5.85
40.00	0.	-10.27	10.00	90.00	-18.39	80.00	90.00	-1.32
50.00	0.	-15.25	20.00	90.00	-12.73	90.00	90.00	0.
60.00	0.	-18.56	30.00	90.00	-10.23			

**** DATA CARD NO. 6 GN -0 -0 -0 -0 6.00000E+00 1.00000E-03 0. 0. 0.
 **** DATA CARD NO. 7 RP 0 10 2 1301 0. 0. 1.00000E+01 9.00000E+01 0. 0.

--- STRUCTURE IMPEDANCE LOADING ---

THIS STRUCTURE IS NOT LOADED

--- ANTENNA ENVIRONMENT ---

FINITE GROUND. REFLECTION COEFFICIENT APPROXIMATION
 RELATIVE DIELECTRIC CONST.= 6.000
 CONDUCTIVITY= 1.000E-03 MHOS/METER
 COMPLEX DIELECTRIC CONSTANT= 6.00000E+00-5.99200E-01

--- MATRIX TIMING ---

FILL= 0.053 SEC. FACTOR= 0.003 SEC.

--- ANTENNA INPUT PARAMETERS ---

TAG NO.	SEG. NO.	VOLTAGE (VOLTS)		CURRENT (AMPS)		IMPEDANCE (OHMS)		ADMITTANCE (MHOS)		POWER (WATTS)
		REAL	IMAG.	REAL	IMAG.	REAL	IMAG.	REAL	IMAG.	
-0	5	1.00000E+00	0.	8.91202E-03	-8.82892E-04	1.11117E+02	1.10081E+01	8.91202E-03	-8.82892E-04	4.45601E-03

--- CURRENTS AND LOCATION ---

DISTANCES IN WAVELENGTHS

SEG. NO.	TAG NO.	COORD. OF CENTER		SEG. LENGTH	CURRENT (AMPS)			PHASE	
		X	Y		REAL	IMAG.	MAG.		
1	-0	0.	0.	0.2279	0.05559	2.8769E-03	-2.5728E-03	3.8595E-03	-41.807
2	-0	0.	0.	0.2835	0.05559	5.4154E-03	-4.1894E-03	6.8467E-03	-37.726
3	-0	0.	0.	0.3391	0.05559	7.2728E-03	-4.6627E-03	8.6391E-03	-32.665
4	-0	0.	0.	0.3947	0.05559	8.4696E-03	-3.7953E-03	9.2810E-03	-24.137
5	-0	0.	0.	0.4503	0.05559	8.9120E-03	-8.8289E-04	8.9557E-03	-5.658
6	-0	0.	0.	0.5059	0.05559	8.5576E-03	-3.8085E-03	9.3689E-03	-23.991
7	-0	0.	0.	0.5615	0.05559	7.4273E-03	-4.6836E-03	8.7807E-03	-32.235
8	-0	0.	0.	0.6171	0.05559	5.5943E-03	-4.2085E-03	7.0005E-03	-36.954
9	-0	0.	0.	0.6727	0.05559	3.0094E-03	-2.5815E-03	3.9649E-03	-40.623

- - - POWER BUDGET - - -

INPUT POWER = 4.4560E-03 WATTS
 RADIATED POWER = 4.4560E-03 WATTS
 STRUCTURE LOSS = 0. WATTS
 NETWORK LOSS = 0. WATTS
 EFFICIENCY = 100.00 PERCENT

- - - RADIATION PATTERNS - - -

- - ANGLES - -		- POWER GAINS -			- - - POLARIZATION - - -			- - - E(THETA) - - -		- - - E(PHI) - - -	
THETA DEGREES	PHI DEGREES	VERT. DB	HOR. DB	TOTAL DB	AXIAL RATIO	TILT DEG.	SENSE	MAGNITUDE VOLTS/M	PHASE DEGREES	MAGNITUDE VOLTS/M	PHASE DEGREES
0.	0.	-999.99	-999.99	-999.99	0.	0.		0.	0.	0.	0.
10.00	0.	-12.87	-999.99	-12.87	0.	0.	LINEAR	1.17472E-01	-124.70	0.	0.
20.00	0.	-7.18	-999.99	-7.18	0.	0.	LINEAR	2.26149E-01	-128.91	0.	0.
30.00	0.	-4.47	-999.99	-4.47	0.	0.	LINEAR	3.08872E-01	-137.31	0.	0.
40.00	0.	-3.45	-999.99	-3.45	0.	0.	LINEAR	3.47271E-01	-153.41	0.	0.
50.00	0.	-2.94	-999.99	-2.94	0.	0.	LINEAR	3.68436E-01	177.07	0.	0.
60.00	0.	-0.79	-999.99	-0.79	0.	0.	LINEAR	4.71934E-01	142.06	0.	0.
70.00	0.	1.54	-999.99	1.54	0.	0.	LINEAR	6.16990E-01	120.37	0.	0.
80.00	0.	0.64	-999.99	0.64	0.	0.	LINEAR	5.56472E-01	110.41	0.	0.
90.00	0.	-999.99	-999.99	-999.99	0.	0.		2.66482E-11	-72.99	0.	0.
0.	90.00	-999.99	-999.99	-999.99	0.	0.		0.	0.	0.	0.
10.00	90.00	-12.87	-999.99	-12.87	0.	0.	LINEAR	1.17472E-01	-124.70	0.	0.
20.00	90.00	-7.18	-999.99	-7.18	0.	0.	LINEAR	2.26149E-01	-128.91	0.	0.
30.00	90.00	-4.47	-999.99	-4.47	0.	0.	LINEAR	3.08872E-01	-137.31	0.	0.
40.00	90.00	-3.45	-999.99	-3.45	0.	0.	LINEAR	3.47271E-01	-153.41	0.	0.
50.00	90.00	-2.94	-999.99	-2.94	0.	0.	LINEAR	3.68436E-01	177.07	0.	0.
60.00	90.00	-0.79	-999.99	-0.79	0.	0.	LINEAR	4.71934E-01	142.06	0.	0.
70.00	90.00	1.54	-999.99	1.54	0.	0.	LINEAR	6.16990E-01	120.37	0.	0.
80.00	90.00	0.64	-999.99	0.64	0.	0.	LINEAR	5.56472E-01	110.41	0.	0.
90.00	90.00	-999.99	-999.99	-999.99	0.	0.		2.66482E-11	-72.99	0.	0.

AVERAGE POWER GAIN = 7.20701E-01 SOLID ANGLE USED IN AVERAGING = (0.50001 * PI) STERADIANS.

- - - - - NORMALIZED GAIN - - - - -

VERTICAL GAIN
 NORMALIZATION FACTOR = 1.54 DB

- - ANGLES - -			GAIN	- - ANGLES - -			GAIN	- - ANGLES - -			GAIN
THETA DEGREES	PHI DEGREES	DB		THETA DEGREES	PHI DEGREES	DB		THETA DEGREES	PHI DEGREES	DB	
0.	0.	-1001.53		70.00	0.	0.		40.00	90.00	-4.99	
10.00	0.	-14.41		80.00	0.	-0.90		50.00	90.00	-4.48	
20.00	0.	-8.72		90.00	0.	-1001.53		60.00	90.00	-2.33	
30.00	0.	-6.01		0.	90.00	-1001.53		70.00	90.00	0.	
40.00	0.	-4.99		10.00	90.00	-14.41		80.00	90.00	-0.90	
50.00	0.	-4.48		20.00	90.00	-8.72		90.00	90.00	-1001.53	
60.00	0.	-2.33		30.00	90.00	-6.01					

***** DATA CARD NO. 8 RP 1 10 1 -0 1.00000E+00 0. 2 00000E+00 0. 1.00000E+05 0.

- - - RADIATED FIELDS NEAR GROUND - - -

- - - LOCATION - - -			- - E(THETA) - -		- - E(PHI) - -		- - E(RADIAL) - -	
RHO METERS	PHI DEGREES	Z METERS	MAG VOLTS/M	PHASE DEGREES	MAG VOLTS/M	PHASE DEGREES	MAG VOLTS/M	PHASE DEGREES
100000.00	0.	1.00	2.3956E-09	142.05	0.	0.	8.5944E-10	-46.45
100000.00	0.	3.00	2.7216E-09	164.43	0.	0.	8.5934E-10	-46.46
100000.00	0.	5.00	3.3543E-09	-179.80	0.	0.	8.5925E-10	-46.46
100000.00	0.	7.00	4.1558E-09	-169.55	0.	0.	8.5915E-10	-46.46
100000.00	0.	9.00	5.0462E-09	-162.76	0.	0.	8.5906E-10	-46.47
100000.00	0.	11.00	5.9859E-09	-158.05	0.	0.	8.5896E-10	-46.47
100000.00	0.	13.00	6.9550E-09	-154.65	0.	0.	8.5887E-10	-46.48
100000.00	0.	15.00	7.9426E-09	-152.08	0.	0.	8.5877E-10	-46.49
100000.00	0.	17.00	8.9426E-09	-150.09	0.	0.	8.5868E-10	-46.50
100000.00	0.	19.00	9.9511E-09	-148.51	0.	0.	8.5858E-10	-46.52

```

***** DATA CARD NO. 9  EX  1  10  1  -0  0.  0.  0.  1.00000E+01  0.  0.
***** DATA CARD NO. 10 PT  2  0  5  5  0.  0.  0.  0.  0.  0.
***** DATA CARD NO. 11 XQ -0  -0  -0  -0  0.  0.  0.  0.  0.  0.

```

```

- - - RECEIVING PATTERN PARAMETERS - - -
ETA= 0. DEGREES
TYPE -LINEAR
AXIAL RATIO=-0.

```

THETA (DEG)	PHI (DEG)	CURRENT MAGNITUDE	PHASE	SEG NO.
0.	0.	0.	0.	5
10.00	0.	6.2309E-03	-34.69	5
20.00	0.	1.1997E-02	-38.90	5
30.00	0.	1.6389E-02	-47.30	5
40.00	0.	1.8430E-02	-63.41	5
50.00	0.	1.9558E-02	-92.93	5
60.00	0.	2.5058E-02	-127.94	5
70.00	0.	3.2766E-02	-149.63	5
80.00	0.	2.9555E-02	-159.59	5
90.00	0.	1.4152E-12	17.01	5

```

- - - NORMALIZED RECEIVING PATTERN - - -
NORMALIZATION FACTOR= 3.2766E-02
ETA= 0. DEGREES
TYPE -LINEAR
AXIAL RATIO=-0.
SEGMENT NO.= 5

```

THETA (DEG)	PHI (DEG)	PATTERN DB	MAGNITUDE
0.	0.	-999.99	0.
10.00	0.	-14.42	1.9016E-01
20.00	0.	-8.73	3.6614E-01
30.00	0.	-6.02	5.0017E-01
40.00	0.	-5.00	5.6248E-01
50.00	0.	-4.48	5.9691E-01
60.00	0.	-2.33	7.6476E-01
70.00	0.	0.00	1.0000E+00
80.00	0.	-0.90	9.0201E-01
90.00	0.	-207.29	4.3191E-11

```

***** DATA CARD NO. 12 NX -0  -0  -0  -0  0.  0.  0.  0.  0.  0.

```

NUMERICAL ELECTROMAGNETICS CODE

----- COMMENTS -----

EXAMPLE 4. T ANTENNA ON A BOX OVER PERFECT GROUND

----- STRUCTURE SPECIFICATION -----

COORDINATES MUST BE INPUT IN METERS OR BE SCALED TO METERS BEFORE STRUCTURE INPUT IS ENDED

WIRE NO.	X1	Y1	Z1	X2	Y2	Z2	RADIUS	NO. OF SEG.	FIRST SEG.	LAST SEG.	TAG NO.
1P	0.10000	0.05000	0.05000	0.	0.	0.01000					
2P	0.05000	0.10000	0.05000	0.	90.00000	0.01000					
STRUCTURE REFLECTED ALONG THE AXES X Y . TAGS INCREMENTED BY -0											
9P	0.	0.	0.10000	90.00000	0.	0.04000					
1	0.	0.	0.10000	0.	0.	0.30000	0.00100	4	1	4	1
2	0.	0.	0.30000	0.15000	0.	0.30000	0.00100	2	5	6	2
3	0.	0.	0.30000	-0.15000	0.	0.30000	0.00100	2	7	8	3

GROUND PLANE SPECIFIED.

WHERE WIRE ENDS TOUCH GROUND, CURRENT WILL BE INTERPOLATED TO IMAGE IN GROUND PLANE.

TOTAL SEGMENTS USED= 8 NO. SEG. IN A SYMMETRIC CELL= 8 SYMMETRY FLAG= 0
 TOTAL PATCHES USED= 12 NO. PATCHES IN A SYMMETRIC CELL= 12

- MULTIPLE WIRE JUNCTIONS -

JUNCTION SEGMENTS (- FOR END 1, + FOR END 2)
 1 4 -5 -7

----- SEGMENTATION DATA -----

COORDINATES IN METERS

I+ AND I- INDICATE THE SEGMENTS BEFORE AND AFTER I

SEG. NO.	COORDINATES OF SEG. CENTER			SEG. LENGTH	ORIENTATION ANGLES		WIRE RADIUS	CONNECTION DATA			TAG NO.
	X	Y	Z		ALPHA	BETA		I-	I	I+	
1	0.	0.	0.12500	0.05000	90.00000	0.	0.00100	10009	1	2	1
2	0.	0.	0.17500	0.05000	90.00000	0.	0.00100		1	2	3
3	0.	0.	0.22500	0.05000	90.00000	0.	0.00100		2	3	4
4	0.	0.	0.27500	0.05000	90.00000	0.	0.00100		3	4	5
5	0.03750	0.	0.30000	0.07500	0.	0.	0.00100	-7	5	6	2
6	0.11250	0.	0.30000	0.07500	0.	0.	0.00100	5	6	0	2
7	-0.03750	0.	0.30000	0.07500	0.	180.00000	0.00100	4	7	8	3
8	-0.11250	0.	0.30000	0.07500	0.	180.00000	0.00100	7	8	0	3

----- SURFACE PATCH DATA -----

COORDINATES IN METERS

PATCH NO.	COORD. OF PATCH CENTER			UNIT NORMAL VECTOR			PATCH AREA	COMPONENTS OF UNIT TANGENT VECTORS					
	X	Y	Z	X	Y	Z		X1	Y1	Z1	X2	Y2	Z2
1	0.10000	0.05000	0.05000	1.0000	0.	0.	0.01000	-0.	1.0000	0.	0.	0.	1.0000
2	0.05000	0.10000	0.05000	-0.0000	1.0000	0.	0.01000	-1.0000	-0.0000	0.	0.	0.	1.0000
3	0.10000	-0.05000	0.05000	1.0000	0.	0.	0.01000	-0.	-1.0000	0.	0.	-0.	1.0000
4	0.05000	-0.10000	0.05000	-0.0000	-1.0000	0.	0.01000	-1.0000	0.0000	0.	0.	-0.	1.0000
5	-0.10000	0.05000	0.05000	-1.0000	0.	0.	0.01000	0.	1.0000	0.	-0.	0.	1.0000
6	-0.05000	0.10000	0.05000	0.0000	1.0000	0.	0.01000	1.0000	-0.0000	0.	-0.	0.	1.0000
7	-0.10000	-0.05000	0.05000	-1.0000	0.	0.	0.01000	0.	-1.0000	0.	-0.	-0.	1.0000
8	-0.05000	-0.10000	0.05000	0.0000	-1.0000	0.	0.01000	1.0000	0.0000	0.	-0.	-0.	1.0000

9	0.05000	0.05000	0.10000	0.	0.	1.0000	0.01000	1.0000	0.	0.	0.	1.0000	0.
10	-0.05000	0.05000	0.10000	0.	0.	1.0000	0.01000	1.0000	0.	0.	0.	1.0000	0.
11	-0.05000	-0.05000	0.10000	0.	0.	1.0000	0.01000	1.0000	0.	0.	0.	1.0000	0.
12	0.05000	-0.05000	0.10000	0.	0.	1.0000	0.01000	1.0000	0.	0.	0.	1.0000	0.

```

***** DATA CARD NO. 1  GN  1  -0  -0  -0  0.  0.  0.  0.  0.  0.
***** DATA CARD NO. 2  EX  -0  1  1  -0  1.00000E+00  0.  0.  0.  0.  0.
***** DATA CARD NO. 3  RP  -0  10  4  1001  0.  0.  1.00000E+01  3.00000E+01  0.  0.

```

- - - - - FREQUENCY - - - - -

FREQUENCY= 2.9980E+02 MHZ
WAVELENGTH= 1.0000E+00 METERS

APPROXIMATE INTEGRATION EMPLOYED FOR SEGMENTS MORE THAN 1.000 WAVELENGTHS APART

- - - STRUCTURE IMPEDANCE LOADING - - -

THIS STRUCTURE IS NOT LOADED

- - - ANTENNA ENVIRONMENT - - -
PERFECT GROUND

- - - MATRIX TIMING - - -

FILL* 0.132 SEC., FACTOR= 0.082 SEC.

- - - ANTENNA INPUT PARAMETERS - - -

TAG NO.	SEG. NO.	VOLTAGE (VOLTS)		CURRENT (AMPS)		IMPEDANCE (OHMS)		ADMITTANCE (MHOS)		POWER (WATTS)
		REAL	IMAG.	REAL	IMAG.	REAL	IMAG.	REAL	IMAG.	
1	1	1.00000E+00	0.	2.25809E-03	-2.71947E-03	1.80727E+02	2.17654E+02	2.25809E-03	-2.71947E-03	1.12904E-03

- - - CURRENTS AND LOCATION - - -

DISTANCES IN WAVELENGTHS

SEG. NO.	TAG NO.	COORD. OF SEG. CENTER			SEG. LENGTH	CURRENT (AMPS)			PHASE
		X	Y	Z		REAL	IMAG.	MAG.	
1	1	0.	0.	0.1250	0.05000	2.2581E-03	-2.7195E-03	3.5348E-03	-50.296
2	1	0.	0.	0.1750	0.05000	2.2309E-03	-3.4896E-03	4.1418E-03	-57.409
3	1	0.	0.	0.2250	0.05000	2.1622E-03	-3.9058E-03	4.4643E-03	-61.032
4	1	0.	0.	0.2750	0.05000	2.0278E-03	-3.8953E-03	4.3915E-03	-62.500
5	2	0.0375	0.	0.3000	0.07500	8.1382E-04	-1.5860E-03	1.7826E-03	-62.836
6	2	0.1125	0.	0.3000	0.07500	3.2206E-04	-6.4890E-04	7.2443E-04	-63.604
7	3	-0.0375	0.	0.3000	0.07500	8.1382E-04	-1.5860E-03	1.7826E-03	-62.836
8	3	-0.1125	0.	0.3000	0.07500	3.2206E-04	-6.4890E-04	7.2443E-04	-63.604

--- SURFACE PATCH CURRENTS ---

DISTANCE IN WAVELENGTHS
CURRENT IN AMPS/METER

PATCH CENTER			SURFACE COMPONENTS				RECTANGULAR COMPONENTS						
X	Y	Z	TANGENT VECTOR 1 MAG.	PHASE	TANGENT VECTOR 2 MAG.	PHASE	REAL	X IMAG.	Y REAL	IMAG.	Z REAL	IMAG.	
1	0.100	0.050	0.050	1.2095E-03	111.88	8.4058E-03	-115.75	0.	0.	-4.51E-04	1.12E-03	-3.65E-03	-7.57E-03
2	0.050	0.100	0.050	1.2018E-03	-68.27	8.2434E-03	-116.57	-4.45E-04	1.12E-03	-2.27E-15	5.71E-15	-3.69E-03	-7.37E-03
3	0.100	-0.050	0.050	1.2095E-03	111.88	8.4058E-03	-115.75	0.	0.	4.51E-04	-1.12E-03	-3.65E-03	-7.57E-03
4	0.050	-0.100	0.050	1.2018E-03	-68.27	8.2434E-03	-116.57	-4.45E-04	1.12E-03	2.27E-15	-5.71E-15	-3.69E-03	-7.37E-03
5	-0.100	0.050	0.050	1.2095E-03	111.88	8.4058E-03	-115.75	0.	0.	-4.51E-04	1.12E-03	-3.65E-03	-7.57E-03
6	-0.050	0.100	0.050	1.2018E-03	-68.27	8.2434E-03	-116.57	4.45E-04	-1.12E-03	-2.27E-15	5.71E-15	-3.69E-03	-7.37E-03
7	-0.100	-0.050	0.050	1.2095E-03	111.88	8.4058E-03	-115.75	0.	0.	4.51E-04	-1.12E-03	-3.65E-03	-7.57E-03
8	-0.050	-0.100	0.050	1.2018E-03	-68.27	8.2434E-03	-116.57	4.45E-04	-1.12E-03	2.27E-15	-5.71E-15	-3.69E-03	-7.37E-03
9	0.050	0.050	0.100	6.9792E-03	111.78	6.7774E-03	111.82	-2.59E-03	6.48E-03	-2.52E-03	6.29E-03	0.	0.
10	-0.050	0.050	0.100	6.9792E-03	-68.22	6.7774E-03	111.82	2.59E-03	-6.48E-03	-2.52E-03	6.29E-03	0.	0.
11	-0.050	-0.050	0.100	6.9792E-03	-68.22	6.7774E-03	-68.18	2.59E-03	-6.48E-03	2.52E-03	-6.29E-03	0.	0.
12	0.050	-0.050	0.100	6.9792E-03	111.78	6.7774E-03	-68.18	-2.59E-03	6.48E-03	2.52E-03	-6.29E-03	0.	0.

--- POWER BUDGET ---

INPUT POWER = 1.1290E-03 WATTS
RADIATED POWER = 1.1290E-03 WATTS
STRUCTURE LOSS = 0. WATTS
NETWORK LOSS = 0. WATTS
EFFICIENCY = 100.00 PERCENT

--- RADIATION PATTERNS ---

ANGLES		POWER GAINS			POLARIZATION			E(THETA)		E(PHI)	
THETA DEGREES	PHI DEGREES	VERT. DB	HOR. DB	TOTAL DB	AXIAL RATIO	TILT DEG.	SENSE	MAGNITUDE VOLTS/M	PHASE DEGREES	MAGNITUDE VOLTS/M	PHASE DEGREES
0.	0.	-999.99	-999.99	-999.99	0.	0.	0.	6.78075E-15	-97.74	1.47269E-16	146.31
10.00	0.	-13.76	-999.99	-13.76	0.00000	-0.00	LINEAR	5.33571E-02	-7.55	2.19958E-16	158.20
20.00	0.	-7.53	-999.99	-7.53	0.00000	-0.00	LINEAR	1.09306E-01	-5.63	2.92407E-16	167.91
30.00	0.	-3.71	-999.99	-3.71	0.00000	-0.00	LINEAR	1.69677E-01	-2.91	3.27399E-16	-176.42
40.00	0.	-0.90	-999.99	-0.90	0.00000	-0.00	LINEAR	2.34570E-01	0.05	1.74491E-16	159.44
50.00	0.	1.28	-999.99	1.28	0.00000	-0.00	LINEAR	3.01472E-01	2.82	1.68409E-16	165.96
60.00	0.	2.94	-999.99	2.94	0.00000	-0.00	LINEAR	3.65093E-01	5.11	7.36346E-17	123.69
70.00	0.	4.12	-999.99	4.12	0.00000	-0.00	LINEAR	4.18286E-01	6.79	1.64652E-16	172.88
80.00	0.	4.83	-999.99	4.83	0.00000	-0.00	LINEAR	4.53811E-01	7.80	8.16903E-17	180.00
90.00	0.	5.07	-999.99	5.07	0.	0.	LINEAR	4.66309E-01	8.13	0.	0.
0.	30.00	-999.99	-999.99	-999.99	0.	0.	0.	5.84046E-15	-98.39	3.44808E-15	84.16
10.00	30.00	-14.02	-37.84	-14.00	0.03738	-3.00	RIGHT	5.18066E-02	-8.73	3.33675E-03	-153.15
20.00	30.00	-7.78	-31.80	-7.76	0.03466	-3.01	RIGHT	1.06290E-01	-6.67	6.69076E-03	-153.15
30.00	30.00	-3.93	-28.38	-3.92	0.03042	-2.96	RIGHT	1.65481E-01	-3.75	9.91400E-03	-153.15
40.00	30.00	-1.08	-26.30	-1.07	0.02517	-2.79	RIGHT	2.29787E-01	-0.56	1.25927E-02	-153.15
50.00	30.00	1.15	-25.34	1.16	0.01957	-2.47	RIGHT	2.96963E-01	2.42	1.40762E-02	-153.15
60.00	30.00	2.86	-25.59	2.87	0.01412	-2.01	RIGHT	3.61723E-01	4.89	1.36726E-02	-153.15
70.00	30.00	4.09	-27.50	4.09	0.00907	-1.42	RIGHT	4.16531E-01	6.68	1.09689E-02	-153.15
80.00	30.00	4.83	-32.55	4.83	0.00442	-0.73	RIGHT	4.53467E-01	7.77	6.13133E-03	-153.15
90.00	30.00	5.07	-999.99	5.07	0.00000	0.00	LINEAR	4.66525E-01	8.13	1.86195E-13	26.89
0.	60.00	-999.99	-999.99	-999.99	0.	0.	0.	3.33654E-15	-99.71	5.90489E-15	82.90
10.00	60.00	-14.54	-37.83	-14.52	0.04222	-3.09	RIGHT	4.87719E-02	-11.33	3.34126E-03	-153.16
20.00	60.00	-8.28	-31.75	-8.26	0.03909	-3.12	RIGHT	1.00327E-01	-8.95	6.72504E-03	-153.16
30.00	60.00	-4.38	-28.29	-4.37	0.03409	-3.09	RIGHT	1.57060E-01	-5.59	1.00184E-02	-153.18
40.00	60.00	-1.46	-26.16	-1.44	0.02787	-2.92	RIGHT	2.20029E-01	-1.89	1.28028E-02	-153.19
50.00	60.00	0.87	-25.14	0.88	0.02130	-2.59	RIGHT	2.87605E-01	1.57	1.43968E-02	-153.20
60.00	60.00	2.69	-25.35	2.70	0.01508	-2.10	RIGHT	3.54583E-01	4.41	1.40578E-02	-153.21
70.00	60.00	4.01	-27.23	4.01	0.00952	-1.47	RIGHT	4.12667E-01	6.48	1.13240E-02	-153.21
80.00	60.00	4.81	-32.26	4.81	0.00458	-0.76	RIGHT	4.52518E-01	7.72	6.34618E-03	-153.22
90.00	60.00	5.08	-999.99	5.08	0.00000	0.00	LINEAR	4.66741E-01	8.13	1.93260E-13	26.79

0.	90.00	-999.99	-999.99	-999.99	0.	0.		1.47269E-16	146.31	6.78075E-15	82.26
10.00	90.00	-14.81	-999.99	-14.81	0.00000	0.00	LINEAR	4.72925E-02	-12.75	4.41849E-14	33.97
20.00	90.00	-8.54	-999.99	-8.54	0.00000	0.00	LINEAR	9.73872E-02	-10.21	8.47743E-14	30.77
30.00	90.00	-4.62	-999.99	-4.62	0.00000	0.00	LINEAR	1.52845E-01	-8.60	1.23313E-13	29.46
40.00	90.00	-1.65	-999.99	-1.65	0.00000	0.00	LINEAR	2.15061E-01	-2.62	1.56630E-13	29.07
50.00	90.00	0.72	-999.99	0.72	0.00000	0.00	LINEAR	2.82757E-01	1.11	1.75895E-13	28.71
60.00	90.00	2.60	-999.99	2.60	0.00000	0.00	LINEAR	3.50612E-01	4.17	1.71424E-13	28.59
70.00	90.00	3.96	-999.99	3.96	0.00000	0.00	LINEAR	4.10557E-01	6.38	1.38243E-13	28.32
80.00	90.00	4.80	-999.99	4.80	0.00000	0.00	LINEAR	4.51913E-01	7.70	7.79636E-14	28.15
90.00	90.00	5.08	-999.99	5.08	0.00000	-0.00	LINEAR	4.66741E-01	8.14	6.72473E-17	151.99

AVERAGE POWER GAIN= 1.79986E+00

SOLID ANGLE USED IN AVERAGING=(0.5000)*PI STERADIANS.

***** DATA CARD NO. 4 EN -0 -0 -0 -0 0. 0. 0. 0. 0. 0.

RUN TIME = 1.319

EXAMPLE 5, LOG-PERIODIC ANTENNA

Example 5 is a practical log-periodic antenna with 12 elements. Input data for the transmission line sections is printed in the table "Network Data." The table "Structure Excitation Data at Network Connection Points" contains the voltage, current, impedance, admittance, and power in each segment to which transmission lines or networks connect. This segment current will differ from the current into the connected transmission line if there are other transmission lines, network ports, or a voltage source providing alternate current paths. Thus, the current printed here for segment 3 differs from that in the table antenna "Input Parameters." The latter is the current through the voltage source and includes the current into the segment and into the transmission line. Power listed in the network-connection table is the power being fed into the segment. A negative power indicates that the structure is feeding power into the network or transmission line.

With 78 segments, file storage must be used for the interaction matrix. The line after data card number 14 shows how the matrix has been divided into blocks for transfer between core and the files. The line "CP TIME TAKEN FOR FACTORIZATION," gives the amount of central processor time used to factor the matrix excluding time spent transferring data between core and the files. Hence it is less than the total time for factoring printed below.

The EX card option has been used to print the relative asymmetry of the driving-point admittance matrix. The driving-point admittance matrix is the matrix of self and mutual admittances of segments connected to transmission lines, network ports, or voltage sources and should be symmetric.

Example 5 Input

```

1
CM 12 ELEMENT LOG PERIODIC ANTENNA IN FREE SPACE.
CM 78 SEGMENTS. SIGMA=D/L RECEIVING AND TRANS. PATTERNS.
CM DIPOLE LENGTH TO DIAMETER RATIO=150.
CE TAU=0.93, SIGMA=0.70, BOOM IMPEDANCE=50. OHMS.
GW 1 5 0. -1. 0. 0. 1. 0. 0.00667
GW 2 5 -.7527 -1.0753 0. -.7527 1.0753 0. .00717
GW 3 5 -1.562 -1.1562 0. -1.562 1.1562 0. .00771
GW 4 5 -2.4323 -1.2432 0. -2.4323 1.2432 0. .00829
GW 5 5 -3.368 -1.3368 0. -3.368 1.3368 0. .00891
GW 6 7 -4.3742 -1.4374 0. -4.3742 1.4374 0. .00958
GW 7 7 -5.4562 -1.5456 0. -5.4562 1.5456 0. .0103
GW 8 7 -6.6195 -1.6619 0. -6.6195 1.6619 0. .01108
GW 9 7 -7.8705 -1.787 0. -7.8705 1.787 0. .01191
GW 10 7 -9.2156 -1.9215 0. -9.2156 1.9215 0. .01291
GW 11 9 -10.6619 -2.0662 0. -10.6619 2.0662 0. .01377
GW 12 9 -12.2171 -2.2217 0. -12.2171 2.2217 0. .01481
GE
FR 46.29
TL 1 3 2 3 -50.
TL 2 3 3 3 -50.
TL 3 3 4 3 -50.
TL 4 3 5 3 -50.
TL 5 3 6 4 -50.
TL 6 4 7 4 -50.
TL 7 4 8 4 -50.
TL 8 4 9 4 -50.
TL 9 4 10 4 -50.
TL 10 4 11 5 -50.
TL 11 5 12 5 -50.
EX 1 3 10 1. .02
RP 37 1 1110 90. 0. -5. 0.
EN

```

Example 5 Output

 NUMERICAL ELECTROMAGNETICS CODE

- - - - COMMENTS - - - -

12 ELEMENT LOG PERIODIC ANTENNA IN FREE SPACE.
 78 SEGMENTS. SIGMA=0/L RECEIVING AND TRANS. PATTERNS.
 DIPOLE LENGTH TO DIAMETER RATIO=150.
 TAU=0.93. SIGMA=0.70. BOOM IMPEDANCE=50. OHMS.

- - - STRUCTURE SPECIFICATION - - -

COORDINATES MUST BE INPUT IN
 METERS OR BE SCALED TO METERS
 BEFORE STRUCTURE INPUT IS ENDED

WIRE NO.	X1	Y1	Z1	X2	Y2	Z2	RADIUS	NO. OF SEG.	FIRST SEG.	LAST SEG.	TAG NO.
1	0.	-1.00000	0.	0.	1.00000	0.	0.00667	5	1	5	1
2	-0.75270	-1.07530	0.	-0.75270	1.07530	0.	0.00717	5	6	10	2
3	-1.56200	-1.15620	0.	-1.56200	1.15620	0.	0.00771	5	11	15	3
4	-2.43230	-1.24320	0.	-2.43230	1.24320	0.	0.00829	5	16	20	4
5	-3.36800	-1.33680	0.	-3.36800	1.33680	0.	0.00891	5	21	25	5
6	-4.37420	-1.43740	0.	-4.37420	1.43740	0.	0.00958	7	26	32	6
7	-5.45620	-1.54560	0.	-5.45620	1.54560	0.	0.01030	7	33	39	7
8	-6.61950	-1.66190	0.	-6.61950	1.66190	0.	0.01108	7	40	46	8
9	-7.87050	-1.78700	0.	-7.87050	1.78700	0.	0.01191	7	47	53	9
10	-9.21560	-1.92150	0.	-9.21560	1.92150	0.	0.01281	7	54	60	10
11	-10.66190	-2.06620	0.	-10.66190	2.06620	0.	0.01377	9	61	69	11
12	-12.21710	-2.22170	0.	-12.21710	2.22170	0.	0.01481	9	70	78	12

TOTAL SEGMENTS USED= 78 NO. SEG. IN A SYMMETRIC CELL= 78 SYMMETRY FLAG= 0

- MULTIPLE WIRE JUNCTIONS -
 JUNCTION SEGMENTS (- FOR END 1, + FOR END 2)
 NONE

- - - - SEGMENTATION DATA - - - -

COORDINATES IN METERS

1+ AND 1- INDICATE THE SEGMENTS BEFORE AND AFTER 1

SEG. NO.	COORDINATES OF SEG. CENTER			SEG. LENGTH	ORIENTATION ANGLES		WIRE RADIUS	CONNECTION DATA			TAG NO.
	X	Y	Z		ALPHA	BETA		1-	1	1+	
1	0.	-0.80000	0.	0.40000	0.	90.00000	0.00667	0	1	2	1
2	0.	-0.40000	0.	0.40000	0.	90.00000	0.00667	1	2	3	1
3	0.	0.00000	0.	0.40000	0.	90.00000	0.00667	2	3	4	1
4	0.	0.40000	0.	0.40000	0.	90.00000	0.00667	3	4	5	1
5	0.	0.80000	0.	0.40000	0.	90.00000	0.00667	4	5	0	1
6	-0.75270	-0.86024	0.	0.43012	0.	90.00000	0.00717	0	6	7	2
7	-0.75270	-0.43012	0.	0.43012	0.	90.00000	0.00717	6	7	8	2
8	-0.75270	0.00000	0.	0.43012	0.	90.00000	0.00717	7	8	9	2
9	-0.75270	0.43012	0.	0.43012	0.	90.00000	0.00717	8	9	10	2
10	-0.75270	0.86024	0.	0.43012	0.	90.00000	0.00717	9	10	0	2
11	-1.56200	-0.92496	0.	0.46248	0.	90.00000	0.00771	0	11	12	3
12	-1.56200	-0.46248	0.	0.46248	0.	90.00000	0.00771	11	12	13	3
13	-1.56200	0.	0.	0.46248	0.	90.00000	0.00771	12	13	14	3
14	-1.56200	0.46248	0.	0.46248	0.	90.00000	0.00771	13	14	15	3
15	-1.56200	0.92496	0.	0.46248	0.	90.00000	0.00771	14	15	0	3
16	-2.43230	-0.99456	0.	0.49728	0.	90.00000	0.00829	0	16	17	4
17	-2.43230	-0.49728	0.	0.49728	0.	90.00000	0.00829	16	17	18	4

18	-2.43230	0.00000	0.	0.49728	0.	90.00000	0.00829	17	18	19	4
19	-2.43230	0.49728	0.	0.49728	0.	90.00000	0.00829	18	19	20	4
20	-2.43230	0.99456	0.	0.49728	0.	90.00000	0.00829	19	20	0	4
21	-3.36800	-1.06944	0.	0.53472	0.	90.00000	0.00891	0	21	22	5
22	-3.36800	-0.53472	0.	0.53472	0.	90.00000	0.00891	21	22	23	5
23	-3.36800	-0.00000	0.	0.53472	0.	90.00000	0.00891	22	23	24	5
24	-3.36800	0.53472	0.	0.53472	0.	90.00000	0.00891	23	24	25	5
25	-3.36800	1.06944	0.	0.53472	0.	90.00000	0.00891	24	25	0	5
26	-4.37420	-1.23206	0.	0.41069	0.	90.00000	0.00958	0	26	27	6
27	-4.37420	-0.82137	0.	0.41069	0.	90.00000	0.00958	26	27	28	6
28	-4.37420	-0.41069	0.	0.41069	0.	90.00000	0.00958	27	28	29	6
29	-4.37420	0.00000	0.	0.41069	0.	90.00000	0.00958	28	29	30	6
30	-4.37420	0.41069	0.	0.41069	0.	90.00000	0.00958	29	30	31	6
31	-4.37420	0.82137	0.	0.41069	0.	90.00000	0.00958	30	31	32	6
32	-4.37420	1.23206	0.	0.41069	0.	90.00000	0.00958	31	32	0	6
33	-5.45620	-1.32490	0.	0.44160	0.	90.00000	0.01030	0	33	34	7
34	-5.45620	-0.88320	0.	0.44160	0.	90.00000	0.01030	33	34	35	7
35	-5.45620	-0.44160	0.	0.44160	0.	90.00000	0.01030	34	35	36	7
36	-5.45620	0.00000	0.	0.44160	0.	90.00000	0.01030	35	36	37	7
37	-5.45620	0.44160	0.	0.44160	0.	90.00000	0.01030	36	37	38	7
38	-5.45620	0.88320	0.	0.44160	0.	90.00000	0.01030	37	38	39	7
39	-5.45620	1.32490	0.	0.44160	0.	90.00000	0.01030	38	39	0	7
40	-6.61950	-1.42449	0.	0.47483	0.	90.00000	0.01108	0	40	41	8
41	-6.61950	-0.94966	0.	0.47483	0.	90.00000	0.01108	40	41	42	8
42	-6.61950	-0.47483	0.	0.47483	0.	90.00000	0.01108	41	42	43	8
43	-6.61950	0.00000	0.	0.47483	0.	90.00000	0.01108	42	43	44	8
44	-6.61950	0.47483	0.	0.47483	0.	90.00000	0.01108	43	44	45	8
45	-6.61950	0.94966	0.	0.47483	0.	90.00000	0.01108	44	45	46	8
46	-6.61950	1.42449	0.	0.47483	0.	90.00000	0.01108	45	46	0	8
47	-7.87050	-1.53171	0.	0.51057	0.	90.00000	0.01191	0	47	48	9
48	-7.87050	-1.02114	0.	0.51057	0.	90.00000	0.01191	47	48	49	9
49	-7.87050	-0.51057	0.	0.51057	0.	90.00000	0.01191	48	49	50	9
50	-7.87050	0.00000	0.	0.51057	0.	90.00000	0.01191	49	50	51	9
51	-7.87050	0.51057	0.	0.51057	0.	90.00000	0.01191	50	51	52	9
52	-7.87050	1.02114	0.	0.51057	0.	90.00000	0.01191	51	52	53	9
53	-7.87050	1.53171	0.	0.51057	0.	90.00000	0.01191	52	53	0	9
54	-9.21560	-1.64700	0.	0.54900	0.	90.00000	0.01281	0	54	55	10
55	-9.21560	-1.09800	0.	0.54900	0.	90.00000	0.01281	54	55	56	10
56	-9.21560	-0.54900	0.	0.54900	0.	90.00000	0.01281	55	56	57	10
57	-9.21560	-0.00000	0.	0.54900	0.	90.00000	0.01281	56	57	58	10
58	-9.21560	0.54900	0.	0.54900	0.	90.00000	0.01281	57	58	59	10
59	-9.21560	1.09800	0.	0.54900	0.	90.00000	0.01281	58	59	60	10
60	-9.21560	1.64700	0.	0.54900	0.	90.00000	0.01281	59	60	0	10
61	-10.66190	-1.83662	0.	0.45916	0.	90.00000	0.01377	0	61	62	11
62	-10.66190	-1.37747	0.	0.45916	0.	90.00000	0.01377	61	62	63	11
63	-10.66190	-0.91831	0.	0.45916	0.	90.00000	0.01377	62	63	64	11
64	-10.66190	-0.45916	0.	0.45916	0.	90.00000	0.01377	63	64	65	11
65	-10.66190	0.	0.	0.45916	0.	90.00000	0.01377	64	65	66	11
66	-10.66190	0.45916	0.	0.45916	0.	90.00000	0.01377	65	66	67	11
67	-10.66190	0.91831	0.	0.45916	0.	90.00000	0.01377	66	67	68	11
68	-10.66190	1.37747	0.	0.45916	0.	90.00000	0.01377	67	68	69	11
69	-10.66190	1.83662	0.	0.45916	0.	90.00000	0.01377	68	69	0	11
70	-12.21710	-1.97484	0.	0.49371	0.	90.00000	0.01481	0	70	71	12
71	-12.21710	-1.48113	0.	0.49371	0.	90.00000	0.01481	70	71	72	12
72	-12.21710	-0.98742	0.	0.49371	0.	90.00000	0.01481	71	72	73	12
73	-12.21710	-0.49371	0.	0.49371	0.	90.00000	0.01481	72	73	74	12
74	-12.21710	0.	0.	0.49371	0.	90.00000	0.01481	73	74	75	12
75	-12.21710	0.49371	0.	0.49371	0.	90.00000	0.01481	74	75	76	12
76	-12.21710	0.98742	0.	0.49371	0.	90.00000	0.01481	75	76	77	12
77	-12.21710	1.48113	0.	0.49371	0.	90.00000	0.01481	76	77	78	12
78	-12.21710	1.97484	0.	0.49371	0.	90.00000	0.01481	77	78	0	12

```

***** DATA CARD NO. 1 FR -0 -0 -0 -0 4.62900E+01 0. 0. 0. 0. 0.
***** DATA CARD NO. 2 TL 1 3 2 3 -5.00000E+01 0. 0. 0. 0. 0.
***** DATA CARD NO. 3 TL 2 3 3 3 -5.00000E+01 0. 0. 0. 0. 0.
***** DATA CARD NO. 4 TL 3 3 4 3 -5.00000E+01 0. 0. 0. 0. 0.
***** DATA CARD NO. 5 TL 4 3 5 3 -5.00000E+01 0. 0. 0. 0. 0.
***** DATA CARD NO. 6 TL 5 3 6 4 -5.00000E+01 0. 0. 0. 0. 0.
***** DATA CARD NO. 7 TL 6 4 7 4 -5.00000E+01 0. 0. 0. 0. 0.
***** DATA CARD NO. 8 TL 7 4 8 4 -5.00000E+01 0. 0. 0. 0. 0.
***** DATA CARD NO. 9 TL 8 4 9 4 -5.00000E+01 0. 0. 0. 0. 0.
***** DATA CARD NO. 10 TL 9 4 10 4 -5.00000E+01 0. 0. 0. 0. 0.
***** DATA CARD NO. 11 TL 10 4 11 5 -5.00000E+01 0. 0. 0. 0. 0.
***** DATA CARD NO. 12 TL 11 5 12 5 -5.00000E+01 0. 0. 0. 0. 0.
***** DATA CARD NO. 13 EX -0 1 3 10 1.00000E+00 0. 0. 0. 2.00000E-02 0.
***** DATA CARD NO. 14 RP -0 37 1 1110 9.00000E+01 0. -5.00000E+00 0. 0. 0.

```

MATRIX FILE STORAGE - NO. BLOCKS= 4 COLUMNS PER BLOCK= 25 COLUMNS IN LAST BLOCK= 3

----- FREQUENCY -----

FREQUENCY= 4.6290E+01 MHZ
WAVELENGTH= 6.4766E+00 METERS

APPROXIMATE INTEGRATION EMPLOYED FOR SEGMENTS MORE THAN 1.000 WAVELENGTHS APART

--- STRUCTURE IMPEDANCE LOADING ---

THIS STRUCTURE IS NOT LOADED

--- ANTENNA ENVIRONMENT ---
FREE SPACE

CP TIME TAKEN FOR FACTORIZATION = 5.74116E-01

--- MATRIX TIMING ---

FILL= 1.845 SEC., FACTOR= 2.861 SEC.

--- NETWORK DATA ---

- FROM -		- TO -		TRANSMISSION LINE		- SHUNT ADMITTANCES (MHOS) -				LINE
TAG NO.	SEG. NO.	TAG NO.	SEG. NO.	IMPEDANCE OHMS	LENGTH METERS	- END ONE -		- END TWO -		TYPE
						REAL	IMAG.	REAL	IMAG.	
1	3	2	8	5.0000E+01	7.5270E-01	0.	0.	0.	0.	CROSSED
2	8	3	13	5.0000E+01	8.0930E-01	0.	0.	0.	0.	CROSSED
3	13	4	18	5.0000E+01	8.7030E-01	0.	0.	0.	0.	CROSSED
4	18	5	23	5.0000E+01	9.3570E-01	0.	0.	0.	0.	CROSSED
5	23	6	29	5.0000E+01	1.0062E+00	0.	0.	0.	0.	CROSSED
6	29	7	36	5.0000E+01	1.0820E+00	0.	0.	0.	0.	CROSSED
7	36	8	43	5.0000E+01	1.1633E+00	0.	0.	0.	0.	CROSSED
8	43	9	50	5.0000E+01	1.2510E+00	0.	0.	0.	0.	CROSSED
9	50	10	57	5.0000E+01	1.3451E+00	0.	0.	0.	0.	CROSSED
10	57	11	65	5.0000E+01	1.4463E+00	0.	0.	0.	0.	CROSSED
11	65	12	74	5.0000E+01	1.5552E+00	0.	0.	2.0000E-02	0.	CROSSED

MAXIMUM RELATIVE ASYMMETRY OF THE DRIVING POINT ADMITTANCE MATRIX IS 1.073E-02 FOR SEGMENTS 65 AND 23
RMS RELATIVE ASYMMETRY IS 5.722E-03

--- STRUCTURE EXCITATION DATA AT NETWORK CONNECTION POINTS ---

TAG NO.	SEG. NO.	VOLTAGE (VOLTS)		CURRENT (AMPS)		IMPEDANCE (OHMS)		ADMITTANCE (MHOS)		POWER (WATTS)
		REAL	IMAG.	REAL	IMAG.	REAL	IMAG.	REAL	IMAG.	
2		8-6.76615E-01	7.27105E-01	-1.87444E-04	-1.90087E-03	3.44065E+02	-3.89878E+02	-1.27250E-03	1.44193E-03	-6.27652E-04
3		13-1.14181E-01	-1.08175E+00	6.83837E-03	2.28688E-03	-6.25976E+01	-1.37254E+02	-2.75067E-03	6.03124E-03	-1.62732E-03
4		18-9.62184E-01	5.03147E-01	-4.58057E-03	1.06832E-02	7.16342E+00	-9.31365E+01	8.20954E-04	1.06738E-02	4.83934E-04
5		23-7.24711E-01	6.58962E-01	-1.37151E-02	3.48001E-03	3.81906E+01	-5.77368E+01	7.96955E-03	1.20464E-02	3.82314E-03
6		29-2.80599E-01	-7.56236E-01	1.69116E-03	-1.27472E-02	5.54296E+01	-2.93664E+01	1.40869E-02	7.46320E-03	4.58257E-03
7		36-5.10272E-01	5.67793E-02	9.62868E-03	-1.20117E-03	5.14585E+01	1.23163E+01	1.93802E-02	-4.39920E-03	2.42252E-03
8		43-2.44968E-01	2.99211E-01	1.37879E-03	5.04759E-03	4.28257E+01	6.02300E+01	7.84111E-03	-1.10277E-02	5.86267E-04
9		50-9.81880E-02	-3.60792E-01	-2.30707E-03	5.52792E-04	4.81224E+00	1.57538E+02	1.93718E-04	-6.34175E-03	1.35420E-05
10		57-3.40099E-01	2.78504E-02	3.63825E-04	-9.09066E-04	1.02651E+02	3.33037E+02	8.45207E-04	-2.74216E-03	4.92093E-05
11		65-9.25522E-02	3.38623E-01	5.72648E-04	5.66062E-04	2.13899E+02	3.79890E+02	1.12538E-03	-1.99869E-03	6.93408E-05
12		74-2.94652E-01	-1.34969E-01	-7.24816E-04	4.78756E-04	1.97400E+02	3.16598E+02	1.41809E-03	-2.27440E-03	7.44755E-05
1	3	1.00000E+00	0.	1.82302E-03	2.30143E-03	2.11487E+02	-2.66988E+02	1.82302E-03	2.30143E-03	9.11508E-04

- - ANTENNA INPUT PARAMETERS - - -

TAG NO.	SEG. NO.	VOLTAGE (VOLTS)		CURRENT (AMPS)		IMPEDANCE (OHMS)		ADMITTANCE (MHOS)		POWER (WATTS)
		REAL	IMAG.	REAL	IMAG.	REAL	IMAG.	REAL	IMAG.	
1	3	1.00000E+00	0.	2.36240E-02	2.50304E-04	4.23251E+01	-4.48449E-01	2.36240E-02	2.50304E-04	1.18120E-02

- - - CURRENTS AND LOCATION - - -

DISTANCES IN WAVELENGTHS

SEG. NO.	TAG NO.	COORD. OF SEG. CENTER			SEG. LENGTH	CURRENT (AMPS)			PHASE
		X	Y	Z		REAL	IMAG.	MAG.	
1	1	0.	-0.1235	0.	0.06176	6.9701E-04	5.6831E-04	8.9933E-04	39.192
2	1	0.	-0.0618	0.	0.06176	1.5440E-03	1.5715E-03	2.2031E-03	45.565
3	1	0.	0.0000	0.	0.06176	1.8230E-03	2.3014E-03	2.9360E-03	51.616
4	1	0.	0.0618	0.	0.06176	1.5440E-03	1.5715E-03	2.2031E-03	45.505
5	1	0.	0.1235	0.	0.06176	6.9701E-04	5.6831E-04	8.9933E-04	39.192
6	2	-0.1152	-0.1328	0.	0.06641	1.9927E-04	-4.7369E-04	5.1390E-04	-67.163
7	2	-0.1152	-0.0664	0.	0.06641	1.5391E-04	-1.3187E-03	1.3277E-03	-83.343
8	2	-0.1152	0.0000	0.	0.06641	1.5391E-04	-1.3187E-03	1.3277E-03	-95.632
9	2	-0.1152	0.0664	0.	0.06641	1.9927E-04	-4.7369E-04	5.1390E-04	-83.343
10	2	-0.1152	0.1328	0.	0.06641	1.9927E-04	-4.7369E-04	5.1390E-04	-67.163
11	3	-0.2412	-0.1428	0.	0.07141	2.1564E-03	9.2255E-04	2.3455E-03	23.162
12	3	-0.2412	-0.0714	0.	0.07141	5.2787E-03	1.9920E-03	5.6420E-03	20.675
13	3	-0.2412	0.	0.	0.07141	5.2787E-03	1.9920E-03	5.6420E-03	18.491
14	3	-0.2412	0.0714	0.	0.07141	2.1564E-03	9.2255E-04	2.3455E-03	20.675
15	3	-0.2412	0.1428	0.	0.07141	2.1564E-03	9.2255E-04	2.3455E-03	23.162
16	4	-0.3756	-0.1536	0.	0.07678	-1.5100E-03	3.5736E-03	3.8795E-03	112.906
17	4	-0.3756	-0.0768	0.	0.07678	-3.6153E-03	8.5166E-03	9.2522E-03	113.001
18	4	-0.3756	0.0000	0.	0.07678	-4.5806E-03	1.0683E-02	1.1624E-02	113.208
19	4	-0.3756	0.0768	0.	0.07678	-3.6153E-03	8.5166E-03	9.2522E-03	113.001
20	4	-0.3756	0.1536	0.	0.07678	-1.5100E-03	3.5736E-03	3.8795E-03	112.906
21	5	-0.5200	-0.1651	0.	0.08256	-4.7273E-03	-9.5637E-04	4.8231E-03	-168.563
22	5	-0.5200	-0.0826	0.	0.08256	-1.1146E-02	-2.5350E-03	1.1431E-02	-167.187
23	5	-0.5200	0.0000	0.	0.08256	-1.1146E-02	-2.5350E-03	1.1431E-02	-165.762
24	5	-0.5200	0.0826	0.	0.08256	-4.7273E-03	-9.5637E-04	4.8231E-03	-167.187
25	5	-0.5200	0.1651	0.	0.08256	-1.1146E-02	-2.5350E-03	1.1431E-02	-168.563
26	6	-0.6754	-0.1902	0.	0.06341	1.3729E-04	-3.3822E-03	3.3850E-03	-87.675
27	6	-0.6754	-0.1268	0.	0.06341	5.5794E-04	-8.3198E-03	8.3385E-03	-86.163
28	6	-0.6754	0.0634	0.	0.06341	1.1472E-03	-1.1516E-02	1.1573E-02	-84.311
29	6	-0.6754	0.0000	0.	0.06341	1.6912E-03	-1.2747E-02	1.2859E-02	-82.443
30	6	-0.6754	0.0634	0.	0.06341	1.1472E-03	-1.1516E-02	1.1573E-02	-84.311
31	6	-0.6754	0.1268	0.	0.06341	5.5794E-04	-8.3198E-03	8.3385E-03	-86.163
32	6	-0.6754	0.1902	0.	0.06341	1.3729E-04	-3.3822E-03	3.3850E-03	-87.675
33	7	-0.8425	-0.2046	0.	0.06818	2.5954E-03	-5.7118E-04	2.6575E-03	-12.412
34	7	-0.8425	-0.1364	0.	0.06818	6.4067E-03	-1.2269E-03	6.5231E-03	-10.841
35	7	-0.8425	-0.0682	0.	0.06818	8.8142E-03	-1.3926E-03	8.9235E-03	-8.978
36	7	-0.8425	0.0000	0.	0.06818	9.6287E-03	-1.2012E-03	9.7033E-03	-7.111
37	7	-0.8425	0.0682	0.	0.06818	8.8142E-03	-1.3926E-03	8.9235E-03	-8.978
38	7	-0.8425	0.1364	0.	0.06818	6.4067E-03	-1.2269E-03	6.5231E-03	-10.841
39	7	-0.8425	0.2046	0.	0.06818	2.5954E-03	-5.7118E-04	2.6575E-03	-12.412
40	8	-1.0221	-0.2199	0.	0.07331	5.2465E-04	1.4101E-03	1.5045E-03	69.591
41	8	-1.0221	-0.1466	0.	0.07331	1.1847E-03	3.4847E-03	3.6806E-03	71.223
42	8	-1.0221	-0.0733	0.	0.07331	1.4458E-03	4.7322E-03	4.9481E-03	73.011
43	8	-1.0221	0.0000	0.	0.07331	1.3788E-03	5.0476E-03	5.2325E-03	74.722
44	8	-1.0221	0.0733	0.	0.07331	1.4458E-03	4.7322E-03	4.9481E-03	73.011
45	8	-1.0221	0.1466	0.	0.07331	1.1847E-03	3.4847E-03	3.6806E-03	71.223
46	8	-1.0221	0.2199	0.	0.07331	5.2465E-04	1.4101E-03	1.5045E-03	69.591
47	9	-1.2152	-0.2365	0.	0.07883	-7.4266E-04	2.0199E-04	7.6964E-04	164.785
48	9	-1.2152	-0.1577	0.	0.07883	-1.7935E-03	4.6188E-04	1.8521E-03	165.559
49	9	-1.2152	-0.0788	0.	0.07883	-2.3192E-03	5.7091E-04	2.3884E-03	166.170
50	9	-1.2152	0.0000	0.	0.07883	-2.3071E-03	5.5279E-04	2.3724E-03	166.526
51	9	-1.2152	0.0788	0.	0.07883	-2.3192E-03	5.7091E-04	2.3884E-03	166.170
52	9	-1.2152	0.1577	0.	0.07883	-1.7935E-03	4.6188E-04	1.8521E-03	165.559
53	9	-1.2152	0.2365	0.	0.07883	-7.4266E-04	2.0199E-04	7.6964E-04	164.785
54	10	-1.4229	-0.2543	0.	0.08477	9.5745E-05	-3.9087E-04	4.0242E-04	-76.236
55	10	-1.4229	-0.1695	0.	0.08477	2.4939E-04	-8.9773E-04	9.3172E-04	-74.475
56	10	-1.4229	-0.0848	0.	0.08477	3.4515E-04	-1.0563E-03	1.1113E-03	-71.906
57	10	-1.4229	0.0000	0.	0.08477	3.6382E-04	-9.0907E-04	9.7917E-04	-68.188
58	10	-1.4229	0.0848	0.	0.08477	3.4515E-04	-1.0563E-03	1.1113E-03	-71.906
59	10	-1.4229	0.1695	0.	0.08477	2.4939E-04	-8.9773E-04	9.3172E-04	-74.475
60	10	-1.4229	0.2543	0.	0.08477	9.5745E-05	-3.9087E-04	4.0242E-04	-76.236
61	11	-1.6462	-0.2836	0.	0.07089	2.7079E-04	1.5010E-04	3.0961E-04	29.000
62	11	-1.6462	-0.2127	0.	0.07089	6.3252E-04	3.7763E-04	7.3667E-04	30.838
63	11	-1.6462	-0.1418	0.	0.07089	8.0838E-04	5.3277E-04	9.6816E-04	33.387
64	11	-1.6462	-0.0709	0.	0.07089	7.6873E-04	5.9417E-04	9.7159E-04	37.701
65	11	-1.6462	0.	0.	0.07089	5.7265E-04	5.6606E-04	8.0520E-04	44.669

66	11	-1.6462	0.0709	0.	0.07089	7.6873E-04	5.9417E-04	9.7159E-04	37.701
67	11	-1.6462	0.1418	0.	0.07089	8.0838E-04	5.3277E-04	9.6816E-04	33.397
68	11	-1.6462	0.2127	0.	0.07089	6.3252E-04	3.7763E-04	7.3667E-04	30.838
69	11	-1.6462	0.2836	0.	0.07089	2.7079E-04	1.5010E-04	3.0961E-04	29.000
70	12	-1.8864	-0.3049	0.	0.07623	-1.9982E-04	2.4071E-04	3.1284E-04	129.698
71	12	-1.8864	-0.2287	0.	0.07623	-5.0501E-04	5.6305E-04	7.5635E-04	131.889
72	12	-1.8864	-0.1525	0.	0.07623	-7.0916E-04	7.1495E-04	1.0070E-03	134.767
73	12	-1.8864	-0.0762	0.	0.07623	-7.7880E-04	6.6718E-04	1.0255E-03	139.414
74	12	-1.8864	0.	0.	0.07623	-7.2482E-04	4.7876E-04	8.6866E-04	146.554
75	12	-1.8864	0.0762	0.	0.07623	-7.7880E-04	6.6718E-04	1.0255E-03	139.414
76	12	-1.8864	0.1525	0.	0.07623	-7.0916E-04	7.1495E-04	1.0070E-03	134.767
77	12	-1.8864	0.2287	0.	0.07623	-5.0501E-04	5.6305E-04	7.5635E-04	131.889
78	12	-1.8864	0.3049	0.	0.07623	-1.9982E-04	2.4071E-04	3.1284E-04	129.698

- - - POWER BUDGET - - -

INPUT POWER = 1.1812E-02 WATTS
 RADIATED POWER= 1.0762E-02 WATTS
 STRUCTURE LOSS= 0. WATTS
 NETWORK LOSS = 1.0504E-03 WATTS
 EFFICIENCY = 91.11 PERCENT

- - - RADIATION PATTERNS - - -

- - ANGLES - -		- DIRECTIVE GAINS -			- - - POLARIZATION - - -			- - - E(THETA) - - -		- - - E(PHI) - - -	
THETA	PHI	VERT.	HOR.	TOTAL	AXIAL	TILT	SENSE	MAGNITUDE	PHASE	MAGNITUDE	PHASE
DEGREES	DEGREES	DB	DB	DB	RATIO	DEG.		VOLTS/M	DEGREES	VOLTS/M	DEGREES
90.00	0.	-999.99	9.75	9.75	0.00000	90.00	LINEAR	0.	0.	2.46922E+00	-56.00
85.00	0.	-999.99	9.70	9.70	0.00000	90.00	LINEAR	0.	0.	2.45352E+00	-65.20
80.00	0.	-999.99	9.53	9.53	0.00000	90.00	LINEAR	0.	0.	2.40689E+00	-62.83
75.00	0.	-999.99	9.25	9.25	0.00000	90.00	LINEAR	0.	0.	2.33093E+00	-58.97
70.00	0.	-999.99	8.86	8.86	0.00000	90.00	LINEAR	0.	0.	2.22889E+00	-53.74
65.00	0.	-999.99	8.37	8.37	0.00000	90.00	LINEAR	0.	0.	2.10616E+00	-47.30
60.00	0.	-999.99	7.79	7.79	0.00000	90.00	LINEAR	0.	0.	1.97023E+00	-39.77
55.00	0.	-999.99	7.15	7.15	0.00000	90.00	LINEAR	0.	0.	1.82916E+00	-31.17
50.00	0.	-999.99	6.45	6.45	0.00000	90.00	LINEAR	0.	0.	1.68849E+00	-21.34
45.00	0.	-999.99	5.70	5.70	0.00000	90.00	LINEAR	0.	0.	1.54747E+00	-9.91
40.00	0.	-999.99	4.81	4.81	0.00000	90.00	LINEAR	0.	0.	1.39759E+00	3.57
35.00	0.	-999.99	3.67	3.67	0.00000	90.00	LINEAR	0.	0.	1.22600E+00	19.48
30.00	0.	-999.99	2.10	2.10	0.00000	90.00	LINEAR	0.	0.	1.02313E+00	38.02
25.00	0.	-999.99	-0.14	-0.14	0.00000	90.00	LINEAR	0.	0.	7.90310E-01	59.26
20.00	0.	-999.99	-3.40	-3.40	0.00000	90.00	LINEAR	0.	0.	5.43329E-01	83.42
15.00	0.	-999.99	-8.27	-8.27	0.00000	90.00	LINEAR	0.	0.	3.10020E-01	111.77
10.00	0.	-999.99	-16.15	-16.15	0.00000	90.00	LINEAR	0.	0.	1.25192E-01	152.57
5.00	0.	-999.99	-19.63	-19.63	0.00000	90.00	LINEAR	0.	0.	5.58644E-02	-103.82
0.	0.	-999.99	-20.66	-20.66	0.00000	90.00	LINEAR	0.	0.	8.37861E-02	-41.89
-5.00	0.	-999.99	-22.14	-22.14	0.00000	90.00	LINEAR	0.	0.	7.44409E-02	-24.87
-10.00	0.	-999.99	-17.70	-17.70	0.00000	90.00	LINEAR	0.	0.	6.27600E-02	-47.83
-15.00	0.	-999.99	-14.43	-14.43	0.00000	90.00	LINEAR	0.	0.	1.04653E-01	-62.63
-20.00	0.	-999.99	-13.31	-13.31	0.00000	90.00	LINEAR	0.	0.	1.52513E-01	-50.23
-25.00	0.	-999.99	-13.96	-13.96	0.00000	90.00	LINEAR	0.	0.	1.73572E-01	-30.90
-30.00	0.	-999.99	-16.41	-16.41	0.00000	90.00	LINEAR	0.	0.	1.61084E-01	-10.69
-35.00	0.	-999.99	-21.41	-21.41	0.00000	90.00	LINEAR	0.	0.	1.21492E-01	7.49
-40.00	0.	-999.99	-29.95	-29.95	0.00000	90.00	LINEAR	0.	0.	6.83281E-02	18.32
-45.00	0.	-999.99	-24.33	-24.33	0.00000	90.00	LINEAR	0.	0.	2.55635E-02	-16.51
-50.00	0.	-999.99	-19.91	-19.91	0.00000	90.00	LINEAR	0.	0.	4.87767E-02	-74.32
-55.00	0.	-999.99	-17.99	-17.99	0.00000	90.00	LINEAR	0.	0.	8.11425E-02	-72.25
-60.00	0.	-999.99	-17.28	-17.28	0.00000	90.00	LINEAR	0.	0.	1.01231E-01	-63.59
-65.00	0.	-999.99	-17.24	-17.24	0.00000	90.00	LINEAR	0.	0.	1.09815E-01	-55.16
-70.00	0.	-999.99	-17.53	-17.53	0.00000	90.00	LINEAR	0.	0.	1.10368E-01	-48.42
-75.00	0.	-999.99	-17.92	-17.92	0.00000	90.00	LINEAR	0.	0.	1.06716E-01	-43.73
-80.00	0.	-999.99	-18.23	-18.23	0.00000	90.00	LINEAR	0.	0.	1.02037E-01	-40.94
-85.00	0.	-999.99	-18.35	-18.35	0.00000	90.00	LINEAR	0.	0.	9.84779E-02	-39.60
-90.00	0.	-999.99	-18.35	-18.35	0.00000	90.00	LINEAR	0.	0.	9.71778E-02	-39.22

- - - - NORMALIZED GAIN - - - -

MAJOR AXIS GAIN
 NORMALIZATION FACTOR = 9.75 DB

- - ANGLES - -			- - ANGLES - -			- - ANGLES - -		
THETA	PHI	GAIN	THETA	PHI	GAIN	THETA	PHI	GAIN
DEGREES	DEGREES	DB	DEGREES	DEGREES	DB	DEGREES	DEGREES	DB
90.00	0.	0.	25.00	0.	-9.90	-35.00	0.	-26.16
85.00	0.	-0.06	20.00	0.	-13.15	-40.00	0.	-31.16
80.00	0.	-0.22	15.00	0.	-18.02	-45.00	0.	-39.70
75.00	0.	-0.50	10.00	0.	-25.90	-50.00	0.	-34.09
70.00	0.	-0.89	5.00	0.	-32.91	-55.00	0.	-29.67
65.00	0.	-1.38	0.	0.	-29.39	-60.00	0.	-27.75
60.00	0.	-1.96	-5.00	0.	-30.42	-65.00	0.	-27.04
55.00	0.	-2.61	-10.00	0.	-31.90	-70.00	0.	-26.99
50.00	0.	-3.30	-15.00	0.	-27.46	-75.00	0.	-27.29
45.00	0.	-4.06	-20.00	0.	-24.19	-80.00	0.	-27.68
40.00	0.	-4.94	-25.00	0.	-23.06	-85.00	0.	-27.98
35.00	0.	-6.08	-30.00	0.	-23.71	-90.00	0.	-28.10
30.00	0.	-7.65						

***** DATA CARD NO. 15 EN -0 -0 -0 -0 0. 0. 0. 0. 0.
 RUN TIME = 17.507

EXAMPLE 6, CYLINDER WITH ATTACHED WIRES

The geometry data for the cylinder with attached wires was discussed in section III-2. The wire on the end of the cylinder is excited first and a radiation pattern is computed. The CP card requests the coupling between the base segments of the two wires. Hence after the second wire has been excited, the table "ISOLATION DATA" is printed. The coupling printed is the maximum that would occur when the source and load are simultaneously matched to their antennas. The table includes the matched load impedance for the second segment and the corresponding input impedance at the first segment. The source impedance would be the conjugate of this input impedance for maximum coupling.

Example 6 Input

CECYLINDER WITH ATTACHED WIRES.

SP		10.	0.	7.3333	0.	0.	38.4	
SP		10.	0.	0.	0.	0.	38.4	
SP		10.	0.	-7.3333	0.	0.	38.4	
GM	1	0.	0.	30.				
SP		6.89	0.	11.	90.	0.	44.88	
SP		6.89	0.	-11.	-90.	0.	44.88	
GR	6							
SP		0.	0.	11.	90.	0.	44.89	
SP		0.	0.	-11.	-90.	0.	44.89	
GW	1	4	0.	0.	11.	0.	23.	.1
GW	2	5	10.	0.	0.	27.6	0.	.2
GS			.01					
GE								
FR	1			465.84				
CP	1	1	2	1				
EX		1	1	1.				
RP	73	1	1000	0.	0.	5.	0.	
EX	2	1	1.					
XQ								
EN								

Example 6 Output

.....
 NUMERICAL ELECTROMAGNETICS CODE

- - - - COMMENTS - - - -

CYLINDER WITH ATTACHED WIRES.

- - - STRUCTURE SPECIFICATION - - -

COORDINATES MUST BE INPUT IN
 METERS OR BE SCALED TO METERS
 BEFORE STRUCTURE INPUT IS ENDED

WIRE NO.	X1	Y1	Z1	X2	Y2	Z2	RADIUS	NO. OF SEG.	FIRST SEG.	LAST SEG.	TAG NO.
1P	10.00000	0.	7.33330	0.	0.	38.40000					
2P	10.00000	0.	0.	0.	0.	38.40000					
3P	10.00000	0.	-7.33330	0.	0.	38.40000					
THE STRUCTURE HAS BEEN MOVED. MOVE DATA CARD IS -											
	-0	1	0.	0.	30.00000	-0.	-0.	-0.			
7P	6.89000	0.	11.00000	90.00000	0.	44.88000					
8P	6.89000	0.	-11.00000	-90.00000	0.	44.88000					
STRUCTURE ROTATED ABOUT Z-AXIS 6 TIMES. LABELS INCREMENTED BY -0											
49P	0.	0.	11.00000	90.00000	0.	44.89000					
50P	0.	0.	-11.00000	-90.00000	0.	44.89000					
1	0.	0.	11.00000	0.	0.	23.00000	0.10000	4	1	4	1
2	10.00000	0.	0.	27.60000	0.	0.	0.20000	5	5	9	2
STRUCTURE SCALED BY FACTOR 0.01000											

TOTAL SEGMENTS USED= 9 NO. SEG. IN A SYMMETRIC CELL= 9 SYMMETRY FLAG= 0
 TOTAL PATCHES USED= 56 NO. PATCHES IN A SYMMETRIC CELL= 56

- MULTIPLE WIRE JUNCTIONS -

JUNCTION SEGMENTS (1 FOR END 1, + FOR END 2)
 NONE

- - - - SEGMENTATION DATA - - - -

COORDINATES IN METERS

I+ AND I- INDICATE THE SEGMENTS BEFORE AND AFTER I

SEG. NO.	COORDINATES OF X	Y	SEG. CENTER Z	SEG. LENGTH	ORIENTATION ANGLES ALPHA	BETA	WIRE RADIUS	CONNECTION DATA I- I I+	TAG NO.
1	0.	0.	0.12500	0.03000	90.00000	0.	0.00100	10052 1 2	1
2	0.	0.	0.15500	0.03000	90.00000	0.	0.00100	1 2 3	1
3	0.	0.	0.18500	0.03000	90.00000	0.	0.00100	2 3 4	1
4	0.	0.	0.21500	0.03000	90.00000	0.	0.00100	3 4 0	1
5	0.11760	0.	0.	0.03520	0.	0.	0.00200	10002 5 6	2
6	0.15280	0.	0.	0.03520	0.	0.	0.00200	5 6 7	2
7	0.18800	0.	0.	0.03520	0.	0.	0.00200	6 7 8	2
8	0.22320	0.	0.	0.03520	0.	0.	0.00200	7 8 9	2
9	0.25840	0.	0.	0.03520	0.	0.	0.00200	8 9 0	2

- - - SURFACE PATCH DATA - - -

COORDINATES IN METERS

PATCH NO.	COORD. OF PATCH CENTER			UNIT NORMAL VECTOR			PATCH AREA	COMPONENTS OF UNIT TANGENT VECTORS					
	X	Y	Z	X	Y	Z		X1	Y1	Z1	X2	Y2	Z2
1	0.10000	0.	0.07333	1.0000	0.	0.	0.00384	-0.	1.0000	0.	0.	0.	1.0000
2	0.10000	0.01549	0.01549	1.0000	0.	0.	0.00096	-0.	1.0000	0.	0.	0.	1.0000
3	0.10000	-0.01549	0.01549	1.0000	0.	0.	0.00096	-0.	1.0000	0.	0.	0.	1.0000
4	0.10000	-0.01549	-0.01549	1.0000	0.	0.	0.00096	-0.	1.0000	0.	0.	0.	1.0000
5	0.10000	0.01549	-0.01549	1.0000	0.	0.	0.00096	-0.	1.0000	0.	0.	0.	1.0000
6	0.10000	0.	-0.07333	1.0000	0.	0.	0.00384	-0.	1.0000	0.	0.	0.	1.0000
7	0.08660	0.05000	0.07333	0.8660	0.5000	0.	0.00384	-0.5000	0.8660	0.	0.	0.	1.0000
8	0.08660	0.05000	0.	0.8660	0.5000	0.	0.00384	-0.5000	0.8660	0.	0.	0.	1.0000
9	0.08660	0.05000	-0.07333	0.8660	0.5000	0.	0.00384	-0.5000	0.8660	0.	0.	0.	1.0000
10	0.06890	0.	0.11000	0.	0.	1.0000	0.00449	1.0000	0.	0.	0.	1.0000	0.
11	0.06890	0.	-0.11000	0.	0.	-1.0000	0.00449	1.0000	0.	0.	0.	-1.0000	0.
12	0.05000	0.08660	0.07333	0.5000	0.8660	0.	0.00384	-0.8660	0.5000	0.	0.	0.	1.0000
13	0.05000	0.08660	0.	0.5000	0.8660	0.	0.00384	-0.8660	0.5000	0.	0.	0.	1.0000
14	0.05000	0.08660	-0.07333	0.5000	0.8660	0.	0.00384	-0.8660	0.5000	0.	0.	0.	1.0000
15	-0.00000	0.10000	0.07333	-0.0000	1.0000	0.	0.00384	-1.0000	-0.0000	0.	0.	0.	1.0000
16	-0.00000	0.10000	0.	-0.0000	1.0000	0.	0.00384	-1.0000	-0.0000	0.	0.	0.	1.0000
17	-0.00000	0.10000	-0.07333	-0.0000	1.0000	0.	0.00384	-1.0000	-0.0000	0.	0.	0.	1.0000
18	0.03445	0.05967	0.11000	0.	0.	1.0000	0.00449	0.5000	0.8660	0.	-0.8660	0.5000	0.
19	0.03445	0.05967	-0.11000	0.	0.	-1.0000	0.00449	0.5000	0.8660	0.	0.8660	-0.5000	0.
20	-0.05000	0.08660	0.07333	-0.5000	0.8660	0.	0.00384	-0.8660	-0.5000	0.	0.	0.	1.0000
21	-0.05000	0.08660	0.	-0.5000	0.8660	0.	0.00384	-0.8660	-0.5000	0.	0.	0.	1.0000
22	-0.05000	0.08660	-0.07333	-0.5000	0.8660	0.	0.00384	-0.8660	-0.5000	0.	0.	0.	1.0000
23	-0.08660	0.05000	0.07333	-0.8660	0.5000	0.	0.00384	-0.5000	-0.8660	0.	0.	0.	1.0000
24	-0.08660	0.05000	0.	-0.8660	0.5000	0.	0.00384	-0.5000	-0.8660	0.	0.	0.	1.0000
25	-0.08660	0.05000	-0.07333	-0.8660	0.5000	0.	0.00384	-0.5000	-0.8660	0.	0.	0.	1.0000
26	-0.03445	0.05967	0.11000	0.	0.	1.0000	0.00449	-0.5000	0.8660	0.	-0.8660	-0.5000	0.
27	-0.03445	0.05967	-0.11000	0.	0.	-1.0000	0.00449	-0.5000	0.8660	0.	0.8660	0.5000	0.
28	-0.10000	-0.00000	0.07333	-1.0000	-0.0000	0.	0.00384	0.0000	-1.0000	0.	0.	0.	1.0000
29	-0.10000	-0.00000	0.	-1.0000	-0.0000	0.	0.00384	0.0000	-1.0000	0.	0.	0.	1.0000
30	-0.10000	-0.00000	-0.07333	-1.0000	-0.0000	0.	0.00384	0.0000	-1.0000	0.	0.	0.	1.0000
31	-0.08660	-0.05000	0.07333	-0.8660	-0.5000	0.	0.00384	0.5000	-0.8660	0.	0.	0.	1.0000
32	-0.08660	-0.05000	0.	-0.8660	-0.5000	0.	0.00384	0.5000	-0.8660	0.	0.	0.	1.0000
33	-0.08660	-0.05000	-0.07333	-0.8660	-0.5000	0.	0.00384	0.5000	-0.8660	0.	0.	0.	1.0000
34	-0.06890	-0.00000	0.11000	0.	0.	1.0000	0.00449	-1.0000	-0.0000	0.	0.0000	-1.0000	0.
35	-0.06890	-0.00000	-0.11000	0.	0.	-1.0000	0.00449	-1.0000	-0.0000	0.	-0.0000	1.0000	0.
36	-0.05000	-0.08660	0.07333	-0.5000	-0.8660	0.	0.00384	0.8660	-0.5000	0.	0.	0.	1.0000
37	-0.05000	-0.08660	0.	-0.5000	-0.8660	0.	0.00384	0.8660	-0.5000	0.	0.	0.	1.0000
38	-0.05000	-0.08660	-0.07333	-0.5000	-0.8660	0.	0.00384	0.8660	-0.5000	0.	0.	0.	1.0000
39	0.00000	-0.10000	0.07333	0.0000	-1.0000	0.	0.00384	1.0000	0.0000	0.	0.	0.	1.0000
40	0.00000	-0.10000	0.	0.0000	-1.0000	0.	0.00384	1.0000	0.0000	0.	0.	0.	1.0000
41	0.00000	-0.10000	-0.07333	0.0000	-1.0000	0.	0.00384	1.0000	0.0000	0.	0.	0.	1.0000
42	-0.03445	-0.05967	0.11000	0.	0.	1.0000	0.00449	-0.5000	-0.8660	0.	0.8660	-0.5000	0.
43	-0.03445	-0.05967	-0.11000	0.	0.	-1.0000	0.00449	-0.5000	-0.8660	0.	-0.8660	0.5000	0.
44	0.05000	-0.08660	0.07333	0.5000	-0.8660	0.	0.00384	0.8660	0.5000	0.	0.	0.	1.0000
45	0.05000	-0.08660	0.	0.5000	-0.8660	0.	0.00384	0.8660	0.5000	0.	0.	0.	1.0000
46	0.05000	-0.08660	-0.07333	0.5000	-0.8660	0.	0.00384	0.8660	0.5000	0.	0.	0.	1.0000
47	0.08660	-0.05000	0.07333	0.8660	-0.5000	0.	0.00384	0.5000	0.8660	0.	0.	0.	1.0000
48	0.08660	-0.05000	0.	0.8660	-0.5000	0.	0.00384	0.5000	0.8660	0.	0.	0.	1.0000
49	0.08660	-0.05000	-0.07333	0.8660	-0.5000	0.	0.00384	0.5000	0.8660	0.	0.	0.	1.0000
50	0.03445	-0.05967	0.11000	0.	0.	1.0000	0.00449	0.5000	-0.8660	0.	0.8660	0.5000	0.
51	0.03445	-0.05967	-0.11000	0.	0.	-1.0000	0.00449	0.5000	-0.8660	0.	-0.8660	-0.5000	0.
52	0.01675	0.01675	0.11000	0.	0.	1.0000	0.00112	1.0000	0.	0.	0.	1.0000	0.
53	-0.01675	0.01675	0.11000	0.	0.	1.0000	0.00112	1.0000	0.	0.	0.	1.0000	0.
54	-0.01675	-0.01675	0.11000	0.	0.	1.0000	0.00112	1.0000	0.	0.	0.	1.0000	0.
55	0.01675	-0.01675	0.11000	0.	0.	1.0000	0.00112	1.0000	0.	0.	0.	1.0000	0.
56	0.	0.	-0.11000	0.	0.	-1.0000	0.00449	1.0000	0.	0.	0.	-1.0000	0.

***** DATA CARD NO. 1 FR -0 1 -0 -0 4.65840E+02 0. 0. 0. 0. 0.
 ***** DATA CARD NO. 2 CP 1 1 2 1 0 0. 0. 0. 0. 0.
 ***** DATA CARD NO. 3 EX -0 1 1 -0 1.00000E+00 0. 0. 0. 0. 0.
 ***** DATA CARD NO. 4 RP -0 73 1 1000 0. 0. 5.00000E+00 0. 0. 0.

MATRIX FILE STORAGE - NO. BLOCKS= 8 COLUMNS PER BLOCK= 16 COLUMNS IN LAST BLOCK= 9

- - - - - FREQUENCY - - - - -
 FREQUENCY= 4.6584E+02 MHZ
 WAVELENGTH= 6.4357E-01 METERS

APPROXIMATE INTEGRATION EMPLOYED FOR SEGMENTS MORE THAN 1.000 WAVELENGTHS APART

- - - STRUCTURE IMPEDANCE LOADING - - -

THIS STRUCTURE IS NOT LOADED

- - - ANTENNA ENVIRONMENT - - -
FREE SPACE

CP TIME TAKEN FOR FACTORIZATION = 2.19609E+00

- - - MATRIX TIMING - - -

FILL = 0.967 SEC., FACTOR = 8.866 SEC.

- - - ANTENNA INPUT PARAMETERS - - -

TAG NO.	SEG. NO.	VOLTAGE (VOLTS)		CURRENT (AMPS)		IMPEDANCE (OHMS)		ADMITTANCE (MHOS)		POWER (WATTS)
		REAL	IMAG.	REAL	IMAG.	REAL	IMAG.	REAL	IMAG.	
1	1	1.00000E+00	0.	1.25133E-03	8.29229E-03	1.77928E+01	-1.17909E+02	1.25133E-03	8.29229E-03	6.25663E-04

- - - CURRENTS AND LOCATION - - -

DISTANCES IN WAVELENGTHS

SEG. NO.	TAG NO.	COORD. OF SEG. CENTER			SEG. LENGTH	CURRENT (AMPS)			PHASE
		X	Y	Z		REAL	IMAG.	MAG.	
1	1	0.	0.	0.1942	0.04662	1.2513E-03	8.2923E-03	8.3862E-03	81.419
2	1	0.	0.	0.2408	0.04662	1.0975E-03	6.5800E-03	6.6709E-03	80.531
3	1	0.	0.	0.2875	0.04662	7.9167E-04	4.3758E-03	4.4468E-03	79.745
4	1	0.	0.	0.3341	0.04662	3.3076E-04	1.7250E-03	1.7565E-03	79.146
5	2	0.1827	0.	0.	0.05470	-7.5907E-04	1.5534E-03	1.7289E-03	116.042
6	2	0.2374	0.	0.	0.05470	-7.0147E-04	1.4307E-03	1.5934E-03	116.119
7	2	0.2921	0.	0.	0.05470	-5.8437E-04	1.1901E-03	1.3258E-03	116.153
8	2	0.3468	0.	0.	0.05470	-4.0801E-04	8.3173E-04	9.2642E-04	116.131
9	2	0.4015	0.	0.	0.05470	-1.6998E-04	3.4747E-04	3.8682E-04	116.068

- - - SURFACE PATCH CURRENTS - - -

DISTANCE IN WAVELENGTHS
CURRENT IN AMPS/METER

PATCH NO.	PATCH CENTER			SURFACE COMPONENTS				RECTANGULAR COMPONENTS					
	X	Y	Z	TANGENT VECTOR 1 MAG.	TANGENT VECTOR 1 PHASE	TANGENT VECTOR 2 MAG.	TANGENT VECTOR 2 PHASE	X REAL	X IMAG.	Y REAL	Y IMAG.	Z REAL	Z IMAG.
1	0.155	0.	0.114	2.4110E-12	68.37	7.1962E-03	-35.22	0.	0.	8.89E-13	2.24E-12	5.88E-03	-4.15E-03
2	0.155	0.024	0.024	9.0012E-03	-65.46	1.4220E-02	-51.34	0.	0.	3.74E-03	-8.19E-03	8.88E-03	-1.11E-02
3	0.155	-0.024	0.024	9.0012E-03	114.54	1.4220E-02	-51.34	0.	0.	-3.74E-03	8.19E-03	8.88E-03	-1.11E-02
4	0.155	-0.024	-0.024	9.0081E-03	114.49	5.0962E-03	84.31	0.	0.	-3.73E-03	8.20E-03	5.05E-04	5.07E-03
5	0.155	0.024	-0.024	9.0081E-03	-65.51	5.0962E-03	84.31	0.	0.	3.73E-03	-8.20E-03	5.05E-04	5.07E-03
6	0.155	0.	-0.114	6.8399E-13	-4.52	1.5972E-03	12.53	0.	0.	6.82E-13	-5.39E-14	1.56E-03	3.48E-04
7	0.135	0.078	0.114	1.8793E-03	-94.87	5.5428E-03	-11.30	7.97E-05	9.36E-04	-1.38E-04	-1.62E-03	5.44E-03	-1.09E-03
8	0.135	0.078	0.	3.9149E-03	-75.49	5.3139E-03	-33.00	-4.90E-04	1.89E-03	8.49E-04	-3.28E-03	4.46E-03	-2.89E-03
9	0.135	0.078	-0.114	1.8133E-03	-94.60	2.9183E-03	-33.42	7.27E-05	9.04E-04	-1.26E-04	-1.57E-03	2.44E-03	-1.61E-03
10	0.107	0.	0.171	1.3691E-02	-104.81	2.5901E-12	102.37	-3.50E-03	-1.32E-02	-5.55E-13	2.53E-12	0.	0.
11	0.107	0.	-0.171	1.5187E-03	-10.62	1.2045E-12	-163.56	1.49E-03	-2.80E-04	1.16E-12	3.41E-13	0.	0.

12														
0.078	0.135	0.114	1.6705E-03	-129.81	4.7414E-03	-8.86	9.26E-04	1.11E-03	-5.35E-04	-6.42E-04	4.68E-03	-7.30E-04		
13														
0.078	0.135	0.	1.6295E-03	-112.84	5.3699E-03	-33.12	5.48E-04	1.30E-03	-3.16E-04	-7.51E-04	4.50E-03	-2.93E-03		
14														
0.078	0.135	-0.114	1.7226E-03	-128.58	4.1506E-03	-48.62	9.30E-04	1.17E-03	-5.37E-04	-6.73E-04	2.74E-03	-3.11E-03		
15														
-0.000	0.155	0.114	1.4450E-03	-160.34	5.3232E-03	11.87	1.36E-03	4.86E-04	1.88E-13	6.73E-14	5.21E-03	1.09E-03		
16														
-0.000	0.155	0.	1.2074E-03	-155.49	5.3690E-03	-32.95	1.10E-03	5.01E-04	1.52E-13	6.94E-14	4.51E-03	-2.92E-03		
17														
-0.000	0.155	-0.114	1.4416E-03	-160.26	4.6031E-03	-54.61	1.36E-03	4.87E-04	1.88E-13	6.74E-14	2.67E-03	-3.75E-03		
18														
0.054	0.093	0.171	1.4845E-02	-105.23	1.6076E-03	-145.64	-8.01E-04	-6.38E-03	-4.04E-03	-1.29E-02	0.	0.		
19														
0.054	0.093	-0.171	1.7548E-03	-50.91	1.6063E-03	35.02	1.69E-03	1.17E-04	3.00E-04	-1.64E-03	0.	0.		
20														
-0.078	0.135	0.114	1.3169E-03	-178.68	5.0409E-03	-2.54	1.14E-03	2.63E-05	6.58E-04	1.52E-05	5.04E-03	-2.24E-04		
21														
-0.078	0.135	0.	9.9496E-04	178.64	5.3744E-03	-33.13	8.61E-04	-2.05E-05	4.97E-04	-1.18E-05	4.50E-03	-2.94E-03		
22														
-0.078	0.135	-0.114	1.3019E-03	178.62	4.3371E-03	-56.63	1.13E-03	-2.72E-05	6.51E-04	-1.57E-05	2.39E-03	-3.62E-03		
23														
-0.135	0.078	0.114	7.0537E-04	161.19	5.7472E-03	9.56	3.34E-04	-1.14E-04	5.78E-04	-1.97E-04	5.67E-03	9.54E-04		
24														
-0.135	0.078	0.	5.8001E-04	165.30	5.3716E-03	-33.03	2.81E-04	-7.36E-05	4.86E-04	-1.27E-04	4.50E-03	-2.93E-03		
25														
-0.135	0.078	-0.114	6.9541E-04	166.60	4.2602E-03	-58.97	3.38E-04	-8.06E-05	5.86E-04	-1.40E-04	2.20E-03	-3.65E-03		
26														
-0.054	0.093	0.171	1.5570E-02	-109.02	1.4143E-03	-176.69	3.76E-03	7.43E-03	-3.69E-03	-1.27E-02	0.	0.		
27														
-0.054	0.093	-0.171	1.7609E-03	-92.00	1.4055E-03	2.99	1.25E-03	9.44E-04	6.48E-04	-1.49E-03	0.	0.		
28														
-0.155	-0.000	0.114	5.3312E-13	-103.74	5.2708E-03	-3.82	-5.19E-23	-2.12E-22	1.27E-13	5.18E-13	5.26E-03	-3.51E-04		
29														
-0.155	-0.000	0.	4.1841E-13	-125.09	5.3701E-03	-33.05	-9.87E-23	-1.40E-22	2.41E-13	3.42E-13	4.50E-03	-2.93E-03		
30														
-0.155	-0.000	-0.114	1.1581E-13	-153.34	4.0753E-03	-57.88	-4.25E-23	-2.13E-23	1.03E-13	5.20E-14	2.17E-03	-3.45E-03		
31														
-0.135	-0.078	0.114	7.0537E-04	-18.81	5.7472E-03	9.56	3.34E-04	-1.14E-04	-5.78E-04	1.97E-04	5.67E-03	9.54E-04		
32														
-0.135	-0.078	0.	5.8001E-04	-14.70	5.3716E-03	-33.03	2.81E-04	-7.36E-05	-4.86E-04	1.27E-04	4.50E-03	-2.93E-03		
33														
-0.135	-0.078	-0.114	6.9541E-04	-13.40	4.2602E-03	-58.97	3.38E-04	-8.06E-05	-5.86E-04	1.40E-04	2.20E-03	-3.65E-03		
34														
-0.107	-0.000	0.171	1.5557E-02	-111.31	3.9138E-13	-73.43	5.65E-03	1.45E-02	2.21E-12	6.32E-12	0.	0.		
35														
-0.107	-0.000	-0.171	1.6720E-03	-112.54	2.2817E-13	-54.54	6.41E-04	1.54E-03	3.95E-13	4.48E-13	0.	0.		
36														
-0.078	-0.135	0.114	1.3169E-03	1.32	5.0409E-03	-2.54	1.14E-03	2.63E-05	-6.58E-04	-1.52E-05	5.04E-03	-2.24E-04		
37														
-0.078	-0.135	0.	9.9496E-04	-1.36	5.3744E-03	-33.13	8.61E-04	-2.05E-05	-4.97E-04	1.18E-05	4.50E-03	-2.94E-03		
38														
-0.078	-0.135	-0.114	1.3019E-03	-1.38	4.3371E-03	-56.63	1.13E-03	-2.72E-05	-6.51E-04	1.57E-05	2.39E-03	-3.62E-03		
39														
0.000	-0.155	0.114	1.4450E-03	19.66	5.3232E-03	11.87	1.36E-03	4.86E-04	7.47E-13	2.67E-13	5.21E-03	1.09E-03		
40														
0.000	-0.155	0.	1.2074E-03	24.52	5.3690E-03	-32.95	1.10E-03	5.01E-04	6.03E-13	2.75E-13	4.51E-03	-2.92E-03		
41														
0.000	-0.155	-0.114	1.4416E-03	19.74	4.6031E-03	-54.61	1.36E-03	4.87E-04	7.44E-13	2.67E-13	2.67E-03	-3.75E-03		
42														
-0.054	-0.093	0.171	1.5570E-02	-109.02	1.4143E-03	3.31	3.76E-03	7.43E-03	3.69E-03	1.27E-02	0.	0.		
43														
-0.054	-0.093	-0.171	1.7609E-03	-92.00	1.4055E-03	-177.01	1.25E-03	9.44E-04	-6.48E-04	1.49E-03	0.	0.		
44														
0.078	-0.135	0.114	1.6705E-03	50.19	4.7414E-03	-8.86	9.26E-04	1.11E-03	5.35E-04	6.42E-04	4.68E-03	-7.30E-04		
45														
0.078	-0.135	0.	1.6295E-03	67.16	5.3699E-03	-33.12	5.48E-04	1.30E-03	3.16E-04	7.51E-04	4.50E-03	-2.93E-03		
46														
0.078	-0.135	-0.114	1.7226E-03	51.42	4.1506E-03	-48.62	9.30E-04	1.17E-03	5.37E-04	6.73E-04	2.74E-03	-3.11E-03		
47														
0.135	-0.078	0.114	1.8793E-03	85.13	5.5428E-03	-11.30	7.97E-05	9.36E-04	1.38E-04	1.62E-03	5.44E-03	-1.09E-03		
48														
0.135	-0.078	0.	3.9149E-03	104.51	5.3139E-03	-33.00	-4.90E-04	1.89E-03	-8.49E-04	3.28E-03	4.46E-03	-2.89E-03		
49														
0.135	-0.078	-0.114	1.8133E-03	85.40	2.9183E-03	-33.42	7.27E-05	9.04E-04	1.26E-04	1.57E-03	2.44E-03	-1.61E-03		
50														
0.054	-0.093	0.171	1.4845E-02	-105.23	1.6076E-03	34.36	-8.01E-04	-6.38E-03	4.04E-03	1.29E-02	0.	0.		
51														
0.054	-0.093	-0.171	1.7548E-03	-50.91	1.6063E-03	-144.98	1.69E-03	1.17E-04	-3.00E-04	1.64E-03	0.	0.		

52	0.026	0.026	0.171	3.7707E-02	-97.61	3.8523E-02	-99.40	-4.99E-03	-3.74E-02	-6.29E-03	-3.80E-02	0.	0.
53	-0.026	0.026	0.171	3.8971E-02	78.78	3.8497E-02	-99.34	7.58E-03	3.82E-02	-6.25E-03	-3.80E-02	0.	0.
54	-0.026	-0.026	0.171	3.8971E-02	78.78	3.8497E-02	80.66	7.58E-03	3.82E-02	6.25E-03	3.80E-02	0.	0.
55	0.026	-0.026	0.171	3.7707E-02	-97.61	3.8523E-02	80.60	-4.99E-03	-3.74E-02	6.29E-03	3.80E-02	0.	0.
56	0.	0.	-0.171	1.3523E-03	18.00	6.6843E-13	177.14	1.29E-03	4.18E-04	6.68E-13	-3.33E-14	0.	0.

--- POWER BUDGET ---

INPUT POWER = 6.2566E-04 WATTS
 RADIATED POWER= 6.2566E-04 WATTS
 STRUCTURE LOSS= 0. WATTS
 NETWORK LOSS = 0. WATTS
 EFFICIENCY = 100.00 PERCENT

--- RADIATION PATTERNS ---

-- ANGLES --		- POWER GAINS -			--- POLARIZATION ---			--- E(THETA) ---		--- E(PHI) ---	
THETA	PHI	VERT.	HOR.	TOTAL	AXIAL	TILT	SENSE	MAGNITUDE	PHASE	MAGNITUDE	PHASE
DEGREES	DEGREES	DB	DB	DB	RATIO	DEG.		VOLTS/M	DEGREES	VOLTS/M	DEGREES
0.	0.	-8.11	-199.61	-8.11	0.00000	0.00	LINEAR	7.61679E-02	-2.26	2.02564E-11	2.66
5.00	0.	-8.34	-199.91	-8.34	0.00000	0.00	LINEAR	7.41609E-02	-2.08	1.95604E-11	6.76
10.00	0.	-8.85	-999.99	-8.85	0.00000	0.00	LINEAR	6.99504E-02	-2.76	1.89880E-11	10.56
15.00	0.	-9.70	-999.99	-9.70	0.00000	0.00	LINEAR	6.33762E-02	-4.63	1.85045E-11	14.02
20.00	0.	-11.02	-999.99	-11.02	0.00000	0.00	LINEAR	5.44956E-02	-8.24	1.81244E-11	17.07
25.00	0.	-12.94	-999.99	-12.94	0.00000	0.00	LINEAR	4.36412E-02	-14.78	1.78279E-11	19.67
30.00	0.	-15.74	-999.99	-15.74	0.00000	0.00	LINEAR	3.15460E-02	-27.33	1.76075E-11	21.78
35.00	0.	-19.30	-999.99	-19.30	0.00000	0.00	LINEAR	2.09971E-02	-55.34	1.74563E-11	23.39
40.00	0.	-19.97	-999.99	-19.97	0.00000	-0.00	LINEAR	1.94286E-02	-107.78	1.73695E-11	24.47
45.00	0.	-16.08	-999.99	-16.08	0.00000	-0.00	LINEAR	3.04209E-02	-145.28	1.73420E-11	25.02
50.00	0.	-12.40	-999.99	-12.40	0.00000	-0.00	LINEAR	4.64494E-02	-163.87	1.73715E-11	25.02
55.00	0.	-9.60	-999.99	-9.60	0.00000	-0.00	LINEAR	6.41565E-02	-175.93	1.74554E-11	24.47
60.00	0.	-7.40	-999.99	-7.40	0.00000	-0.00	LINEAR	8.26336E-02	174.32	1.75942E-11	23.39
65.00	0.	-5.61	-999.99	-5.61	0.00000	-0.00	LINEAR	1.01578E-01	165.52	1.77895E-11	21.78
70.00	0.	-4.10	-999.99	-4.10	0.00000	-0.00	LINEAR	1.20851E-01	157.18	1.80437E-11	19.68
75.00	0.	-2.80	-999.99	-2.80	0.00000	-0.00	LINEAR	1.40313E-01	149.15	1.83599E-11	17.11
80.00	0.	-1.67	-999.99	-1.67	0.00000	-0.00	LINEAR	1.59736E-01	141.42	1.87420E-11	14.13
85.00	0.	-0.70	-999.99	-0.70	0.00000	-0.00	LINEAR	1.78758E-01	133.99	1.91975E-11	10.77
90.00	0.	0.14	-199.84	0.14	0.00000	-0.00	LINEAR	1.96871E-01	126.92	1.97270E-11	7.12
95.00	0.	0.84	-199.58	0.84	0.00000	-0.00	LINEAR	2.13447E-01	120.23	2.03358E-11	3.25
100.00	0.	1.41	-199.29	1.41	0.00000	-0.00	LINEAR	2.27788E-01	113.95	2.10224E-11	-0.78
105.00	0.	1.83	-198.98	1.83	0.00000	-0.00	LINEAR	2.39180E-01	108.08	2.17825E-11	-4.88
110.00	0.	2.11	-198.66	2.11	0.00000	-0.00	LINEAR	2.46958E-01	102.65	2.26093E-11	-8.98
115.00	0.	2.24	-198.32	2.24	0.00000	-0.00	LINEAR	2.50561E-01	97.66	2.34913E-11	-13.03
120.00	0.	2.20	-197.99	2.20	0.00000	-0.00	LINEAR	2.49579E-01	93.15	2.44145E-11	-16.97
125.00	0.	2.00	-197.66	2.00	0.00000	-0.00	LINEAR	2.43789E-01	89.16	2.53657E-11	-20.77
130.00	0.	1.61	-197.33	1.61	0.00000	-0.00	LINEAR	2.33171E-01	85.74	2.63268E-11	-24.41
135.00	0.	1.02	-197.02	1.02	0.00000	-0.00	LINEAR	2.17932E-01	82.99	2.72867E-11	-27.86
140.00	0.	0.21	-196.73	0.21	0.00000	-0.00	LINEAR	1.98504E-01	81.07	2.82341E-11	-31.12
145.00	0.	-0.85	-196.45	-0.85	0.00000	-0.00	LINEAR	1.75551E-01	80.23	2.91612E-11	-34.20
150.00	0.	-2.22	-196.18	-2.22	0.00000	-0.00	LINEAR	1.50002E-01	80.93	3.00638E-11	-37.08
155.00	0.	-3.93	-195.93	-3.93	0.00000	-0.00	LINEAR	1.23132E-01	83.98	3.09412E-11	-39.79
160.00	0.	-6.02	-195.69	-6.02	0.00000	-0.00	LINEAR	9.68249E-02	90.96	3.17973E-11	-42.31
165.00	0.	-8.33	-195.47	-8.33	0.00000	-0.00	LINEAR	7.42595E-02	104.77	3.26370E-11	-44.67
170.00	0.	-10.04	-195.25	-10.04	0.00000	-0.00	LINEAR	6.09913E-02	128.42	3.34676E-11	-46.87
175.00	0.	-9.83	-195.04	-9.83	0.00000	-0.00	LINEAR	6.24519E-02	156.53	3.42962E-11	-48.91
180.00	0.	-8.13	-194.83	-8.13	0.00000	-0.00	LINEAR	7.59544E-02	177.76	3.51292E-11	-50.81
185.00	0.	-6.24	-194.62	-6.24	0.00000	-0.00	LINEAR	9.43853E-02	-168.89	3.59723E-11	-52.55
190.00	0.	-4.65	-194.42	-4.65	0.00000	-0.00	LINEAR	1.13349E-01	-159.93	3.68277E-11	-54.15
195.00	0.	-3.40	-194.22	-3.40	0.00000	-0.00	LINEAR	1.30928E-01	-152.98	3.76951E-11	-55.60
200.00	0.	-2.43	-194.02	-2.43	0.00000	0.00	LINEAR	1.46407E-01	-146.80	3.85703E-11	-56.91
205.00	0.	-1.68	-193.82	-1.68	0.00000	0.00	LINEAR	1.59677E-01	-140.77	3.94479E-11	-58.08
210.00	0.	-1.08	-193.63	-1.08	0.00000	0.00	LINEAR	1.70954E-01	-134.57	4.03149E-11	-59.10
215.00	0.	-0.61	-193.45	-0.61	0.00000	0.00	LINEAR	1.80613E-01	-128.05	4.11592E-11	-59.96
220.00	0.	-0.21	-193.28	-0.21	0.00000	0.00	LINEAR	1.89045E-01	-121.22	4.19663E-11	-60.67
225.00	0.	0.13	-193.13	0.13	0.00000	0.00	LINEAR	1.96540E-01	-114.15	4.27120E-11	-61.21
230.00	0.	0.42	-193.00	0.42	0.00000	0.00	LINEAR	2.03207E-01	-106.92	4.33830E-11	-61.58
235.00	0.	0.66	-192.88	0.66	0.00000	0.00	LINEAR	2.08952E-01	-99.67	4.39580E-11	-61.77
240.00	0.	0.85	-192.79	0.85	0.00000	0.00	LINEAR	2.13503E-01	-92.48	4.44162E-11	-61.77
245.00	0.	0.97	-192.73	0.97	0.00000	0.00	LINEAR	2.16480E-01	-85.42	4.47396E-11	-61.59
250.00	0.	1.01	-192.70	1.01	0.00000	0.00	LINEAR	2.17478E-01	-78.55	4.49108E-11	-61.20
255.00	0.	0.95	-192.69	0.95	0.00000	0.00	LINEAR	2.16147E-01	-71.88	4.49155E-11	-60.61
260.00	0.	0.80	-192.73	0.80	0.00000	0.00	LINEAR	2.12257E-01	-65.42	4.47415E-11	-59.80

265.00	0.	0.52	-192.80	0.52	0.00000	0.00	LINEAR	2.05736E-01	-59.17	4.43809E-11	-58.77
270.00	0.	0.13	-192.91	0.13	0.00000	0.00	LINEAR	1.96690E-01	-53.13	4.38291E-11	-57.52
275.00	0.	-0.38	-193.06	-0.38	0.00000	0.00	LINEAR	1.85395E-01	-47.32	4.30884E-11	-56.04
280.00	0.	-1.02	-193.24	-1.02	0.00000	0.00	LINEAR	1.72286E-01	-41.75	4.21629E-11	-54.32
285.00	0.	-1.77	-193.47	-1.77	0.00000	0.00	LINEAR	1.57916E-01	-36.46	4.10637E-11	-52.37
290.00	0.	-2.64	-193.74	-2.64	0.00000	0.00	LINEAR	1.42926E-01	-31.49	3.98064E-11	-50.17
295.00	0.	-3.60	-194.05	-3.60	0.00000	0.00	LINEAR	1.27985E-01	-26.91	3.84113E-11	-47.74
300.00	0.	-4.62	-194.40	-4.62	0.00000	0.00	LINEAR	1.13793E-01	-22.79	3.69026E-11	-45.05
305.00	0.	-5.66	-194.78	-5.66	0.00000	0.00	LINEAR	1.00936E-01	-19.23	3.53086E-11	-42.12
310.00	0.	-6.66	-195.20	-6.66	0.00000	0.00	LINEAR	8.99434E-02	-16.30	3.36595E-11	-38.93
315.00	0.	-7.55	-195.64	-7.55	0.00000	0.00	LINEAR	8.11962E-02	-14.02	3.19879E-11	-35.50
320.00	0.	-8.25	-196.11	-8.25	0.00000	0.00	LINEAR	7.48991E-02	-12.32	3.03255E-11	-31.83
325.00	0.	-8.71	-196.58	-8.71	0.00000	0.00	LINEAR	7.10508E-02	-11.01	2.87033E-11	-27.92
330.00	0.	-8.91	-197.07	-8.91	0.00000	0.00	LINEAR	6.94329E-02	-9.94	2.71498E-11	-23.81
335.00	0.	-8.89	-197.55	-8.89	0.00000	0.00	LINEAR	6.96309E-02	-8.60	2.56897E-11	-19.53
340.00	0.	-8.71	-198.02	-8.71	0.00000	0.00	LINEAR	7.10825E-02	-7.21	2.43417E-11	-15.11
345.00	0.	-8.46	-198.46	-8.46	0.00000	0.00	LINEAR	7.31355E-02	-5.72	2.31196E-11	-10.61
350.00	0.	-8.23	-198.88	-8.23	0.00000	0.00	LINEAR	7.51037E-02	-4.27	2.20316E-11	-6.10
355.00	0.	-8.09	-199.27	-8.09	0.00000	0.00	LINEAR	7.63166E-02	-3.06	2.10781E-11	-1.65
360.00	0.	-8.11	-199.61	-8.11	0.00000	0.00	LINEAR	7.61679E-02	-2.26	2.02566E-11	2.66

**** DATA CARD NO. 5 EX -0 2 1 -0 1.00000E+00 0. 0. 0. 0. 0.
 **** DATA CARD NO. 6 XO -0 -0 -0 -0 0. 0. 0. 0. 0. 0.

--- ANTENNA INPUT PARAMETERS ---

TAG NO.	SEG. NO.	VOLTAGE (VOLTS) REAL	IMAG.	CURRENT (AMPS) REAL	IMAG.	IMPEDANCE (OHMS) REAL	IMAG.	ADMITTANCE (MHOS) REAL	IMAG.	POWER (WATTS)
2	5	1.00000E+00	0.	1.50259E-02	-6.91322E-03	5.49252E+01	2.52703E+01	1.50259E-02	-6.91322E-03	7.51296E-03

--- CURRENTS AND LOCATION ---

DISTANCES IN WAVELENGTHS

SEG. NO.	TAG NO.	COORD. X	COORD. Y	COORD. Z	SEG. LENGTH	CURRENT (AMPS) REAL	IMAG.	MAG.	PHASE
1	1	0.	0.	0.1942	0.04662	-9.0550E-04	1.7154E-03	1.9397E-03	117.829
2	1	0.	0.	0.2408	0.04662	-7.8768E-04	1.5063E-03	1.6999E-03	117.605
3	1	0.	0.	0.2875	0.04662	-5.5897E-04	1.0890E-03	1.2241E-03	117.170
4	1	0.	0.	0.3341	0.04662	-2.2827E-04	4.5625E-04	5.1017E-04	116.580
5	2	0.1827	0.	0.	0.05470	1.5026E-02	-6.9132E-03	1.6540E-02	-24.707
6	2	0.2374	0.	0.	0.05470	1.3800E-02	-7.4043E-03	1.5661E-02	-28.216
7	2	0.2921	0.	0.	0.05470	1.1401E-02	-6.7802E-03	1.3265E-02	-30.740
8	2	0.3468	0.	0.	0.05470	7.8887E-03	-5.0212E-03	9.3512E-03	-32.477
9	2	0.4015	0.	0.	0.05470	3.2560E-03	-2.1815E-03	3.9192E-03	-33.821

--- SURFACE PATCH CURRENTS ---

DISTANCE IN WAVELENGTHS
CURRENT IN AMPS/METER

--- SURFACE COMPONENTS ---						--- RECTANGULAR COMPONENTS ---						
PATCH CENTER			TANGENT VECTOR 1			TANGENT VECTOR 2			RECTANGULAR COMPONENTS			
X	Y	Z	MAG.	PHASE	MAG.	PHASE	REAL	IMAG.	REAL	IMAG.	REAL	IMAG.
0.155	0.	0.114	2.5768E-12	-142.35	4.0390E-02	140.22	0.	0.	-2.04E-12	-1.57E-12	-3.10E-02	2.58E-02
0.155	0.024	0.024	8.6315E-02	153.29	8.8850E-02	152.99	0.	0.	-7.71E-02	3.88E-02	-7.92E-02	4.04E-02
0.155	-0.024	0.024	8.6315E-02	-26.71	8.8850E-02	152.99	0.	0.	7.71E-02	-3.88E-02	-7.92E-02	4.04E-02
0.155	0.024	-0.024	8.6312E-02	153.29	9.1286E-02	-26.16	0.	0.	-7.71E-02	3.88E-02	8.19E-02	-4.02E-02
0.155	-0.024	-0.024	8.6312E-02	-26.71	9.1286E-02	-26.16	0.	0.	7.71E-02	-3.88E-02	8.19E-02	-4.02E-02
0.155	0.	-0.114	2.6964E-12	-130.94	4.1814E-02	-37.70	0.	0.	-1.77E-12	-2.04E-12	3.31E-02	-2.56E-02
0.135	0.078	0.114	1.7533E-02	121.83	2.2201E-02	129.65	4.62E-03	-7.45E-03	-8.01E-03	1.29E-02	-1.42E-02	1.71E-02

8	0.135	0.078	0.	3.7641E-02	141.92	1.3236E-03	2.35	1.48E-02	-1.16E-02	-2.57E-02	2.01E-02	1.32E-03	5.43E-05
9	0.135	0.078	-0.114	1.7516E-02	121.84	2.3097E-02	-45.71	4.62E-03	-7.44E-03	-8.00E-03	1.29E-02	1.61E-02	-1.65E-02
10	0.107	0.	0.171	2.0213E-02	-85.04	1.3922E-11	-60.62	1.75E-03	-2.01E-02	6.83E-12	-1.21E-11	0.	0.
11	0.107	0.	-0.171	1.6874E-02	-87.11	1.4404E-11	121.30	8.52E-04	-1.69E-02	7.48E-12	-1.23E-11	0.	0.
12	0.078	0.135	0.114	1.6710E-02	87.52	6.2225E-03	106.04	-6.27E-04	-1.45E-02	3.62E-04	8.35E-03	-1.72E-03	5.98E-03
13	0.078	0.135	0.	1.5767E-02	103.50	1.3328E-03	2.80	3.19E-03	-1.33E-02	-1.84E-03	7.67E-03	1.33E-03	6.52E-05
14	0.078	0.135	-0.114	1.6654E-02	87.45	6.8118E-03	-56.50	-6.43E-04	-1.44E-02	3.71E-04	8.32E-03	3.76E-03	-5.68E-03
15	-0.000	0.155	0.114	1.3965E-02	55.64	1.7990E-03	89.81	-7.88E-03	-1.15E-02	-1.09E-12	-1.60E-12	5.84E-06	1.80E-03
16	-0.000	0.155	0.	1.1670E-02	60.49	1.3310E-03	3.41	-5.75E-03	-1.02E-02	-7.96E-13	-1.41E-12	1.33E-03	7.93E-05
17	-0.000	0.155	-0.114	1.3951E-02	55.62	2.2807E-03	-31.00	-7.88E-03	-1.15E-02	-1.09E-12	-1.59E-12	1.95E-03	-1.17E-03
18	0.054	0.093	0.171	9.5477E-03	-98.11	1.5574E-02	70.79	-5.11E-03	-1.75E-02	1.40E-03	-8.33E-04	0.	0.
19	0.054	0.093	-0.171	6.5731E-03	-109.90	1.5542E-02	-109.24	-5.55E-03	-1.58E-02	6.24E-04	1.98E-03	0.	0.
20	-0.078	0.135	0.114	1.2623E-02	34.28	1.5698E-03	179.32	-9.03E-03	-6.16E-03	-5.22E-03	-3.55E-03	-1.57E-03	1.86E-05
21	-0.078	0.135	0.	9.6163E-03	34.25	1.3372E-03	3.28	-6.88E-03	-4.69E-03	-3.97E-03	-2.71E-03	1.33E-03	7.65E-05
22	-0.078	0.135	-0.114	1.2602E-02	34.42	3.6442E-03	5.05	-9.00E-03	-6.17E-03	-5.20E-03	-3.56E-03	3.63E-03	3.21E-04
23	-0.135	0.078	0.114	6.7433E-03	22.42	4.2066E-03	-179.29	-3.12E-03	-1.29E-03	-5.40E-03	-2.23E-03	-4.21E-03	-5.19E-05
24	-0.135	0.078	0.	5.6061E-03	21.56	1.3441E-03	3.20	-2.61E-03	-1.03E-03	-4.52E-03	-1.78E-03	1.34E-03	7.51E-05
25	-0.135	0.078	-0.114	6.7305E-03	22.44	6.2415E-03	6.27	-3.11E-03	-1.28E-03	-5.39E-03	-2.22E-03	6.20E-03	6.81E-04
26	-0.054	0.093	0.171	5.5923E-03	3.15	1.3634E-02	38.74	-1.20E-02	-7.54E-03	-4.82E-04	-4.00E-03	0.	0.
27	-0.054	0.093	-0.171	5.8822E-03	37.27	1.3609E-02	-141.24	-1.15E-02	-9.16E-03	-1.25E-03	-1.18E-03	0.	0.
28	-0.155	-0.000	0.114	3.2230E-12	143.29	4.2242E-03	178.48	-1.06E-21	7.90E-22	2.58E-12	-1.93E-12	-4.22E-03	1.12E-04
29	-0.155	-0.000	0.	4.1149E-12	115.22	1.3471E-03	3.05	-7.19E-22	1.53E-21	1.75E-12	-3.72E-12	1.35E-03	7.18E-05
30	-0.155	-0.000	-0.114	3.3315E-12	142.78	6.3084E-03	2.13	-1.09E-21	8.27E-22	2.65E-12	-2.02E-12	6.30E-03	2.34E-04
31	-0.135	-0.078	0.114	6.7433E-03	-157.58	4.2066E-03	-179.29	-3.12E-03	-1.29E-03	5.40E-03	2.23E-03	-4.21E-03	-5.19E-05
32	-0.135	-0.078	0.	5.6061E-03	-158.44	1.3441E-03	3.20	-2.61E-03	-1.03E-03	4.52E-03	1.78E-03	1.34E-03	7.51E-05
33	-0.135	-0.078	-0.114	6.7305E-03	-157.56	6.2415E-03	6.27	-3.11E-03	-1.28E-03	5.39E-03	2.22E-03	6.20E-03	6.81E-04
34	-0.107	-0.000	0.171	1.1520E-02	9.48	3.0306E-12	159.12	-1.14E-02	-1.90E-03	-1.83E-12	-1.86E-12	0.	0.
35	-0.107	-0.000	-0.171	1.1548E-02	26.24	3.1761E-12	-21.29	-1.04E-02	-5.15E-03	-1.33E-12	-3.27E-12	0.	0.
36	-0.078	-0.135	0.114	1.2623E-02	-145.72	1.5698E-03	179.32	-9.03E-03	-6.16E-03	5.22E-03	3.55E-03	-1.57E-03	1.86E-05
37	-0.078	-0.135	0.	9.6163E-03	-145.75	1.3372E-03	3.28	-6.88E-03	-4.69E-03	3.97E-03	2.71E-03	1.33E-03	7.65E-05
38	-0.078	-0.135	-0.114	1.2602E-02	-145.58	3.6442E-03	5.05	-9.00E-03	-6.17E-03	5.20E-03	3.56E-03	3.63E-03	3.21E-04
39	0.000	-0.155	0.114	1.3965E-02	-124.36	1.7990E-03	89.81	-7.88E-03	-1.15E-02	-4.32E-12	-6.32E-12	5.84E-06	1.80E-03
40	0.000	-0.155	0.	1.1670E-02	-119.52	1.3310E-03	3.41	-5.75E-03	-1.02E-02	-3.15E-12	-5.57E-12	1.33E-03	7.93E-05
41	0.000	-0.155	-0.114	1.3951E-02	-124.38	2.2807E-03	-31.00	-7.88E-03	-1.15E-02	-4.32E-12	-6.32E-12	1.95E-03	-1.17E-03
42	-0.054	-0.093	0.171	5.5923E-03	3.15	1.3634E-02	-141.26	-1.20E-02	-7.54E-03	4.82E-04	4.00E-03	0.	0.
43	-0.054	-0.093	-0.171	5.8822E-03	37.27	1.3609E-02	38.76	-1.15E-02	-9.16E-03	1.25E-03	1.18E-03	0.	0.
44	0.078	-0.135	0.114	1.6710E-02	-92.48	6.2225E-03	106.04	-6.27E-04	-1.45E-02	-3.62E-04	-8.35E-03	-1.72E-03	5.98E-03
45	0.078	-0.135	0.	1.5767E-02	-76.50	1.3328E-03	2.80	3.19E-03	-1.33E-02	1.84E-03	-7.67E-03	1.33E-03	6.52E-05
46	0.078	-0.135	-0.114	1.6654E-02	-92.55	6.8118E-03	-56.50	-6.43E-04	-1.44E-02	-3.71E-04	-8.32E-03	3.76E-03	-5.68E-03
47	0.135	-0.078	0.114	1.7533E-02	-58.17	2.2201E-02	129.65	4.62E-03	-7.45E-03	8.01E-03	-1.29E-02	-1.42E-02	1.71E-02
48	0.135	-0.078	0.	3.7641E-02	-38.08	1.3236E-03	2.35	1.48E-02	-1.16E-02	2.57E-02	-2.01E-02	1.32E-03	5.43E-05

```

49
0.135 -0.078 -0.114 1.7516E-02 -58.17 2.3097E-02 -45.71 4.62E-03 -7.44E-03 8.00E-03 -1.29E-02 1.61E-02 -1.65E-02
50
0.054 -0.093 0.171 9.5477E-03 -98.11 1.5574E-02 -109.22 -5.11E-03 -1.75E-02 -1.40E-03 8.33E-04 0. 0.
51
0.054 -0.093 -0.171 6.5731E-03 -109.90 1.5542E-02 70.76 -5.55E-03 -1.58E-02 -6.24E-04 -1.98E-03 0. 0.
52
0.026 0.026 0.171 2.0111E-02 -97.14 8.6900E-03 -62.33 -2.50E-03 -2.00E-02 4.04E-03 -7.70E-03 0. 0.
53
-0.026 0.026 0.171 1.2974E-02 -174.05 8.9442E-03 -64.51 -1.29E-02 -1.35E-03 3.85E-03 -8.07E-03 0. 0.
54
-0.026 -0.026 0.171 1.2974E-02 -174.05 8.9442E-03 115.49 -1.29E-02 -1.35E-03 -3.85E-03 8.07E-03 0. 0.
55
0.026 -0.026 0.171 2.0111E-02 -97.14 8.6900E-03 117.67 -2.50E-03 -2.00E-02 -4.04E-03 7.70E-03 0. 0.
56
0. 0. -0.171 1.3088E-02 -126.31 4.7379E-12 85.35 -7.75E-03 -1.05E-02 -3.84E-13 -4.72E-12 0. 0.

```

- - - POWER BUDGET - - -

```

INPUT POWER = 7.5130E-03 WATTS
RADIATED POWER = 7.5130E-03 WATTS
STRUCTURE LOSS = 0. WATTS
NETWORK LOSS = 0. WATTS
EFFICIENCY = 100.00 PERCENT

```

- - - ISOLATION DATA - - -

```

- - COUPLING BETWEEN - - -
TAG/SEG.  NO.  TAG/SEG.  NO.  MAXIMUM COUPLING (DB)  LOAD IMPEDANCE (2ND SEG.)  INPUT IMPEDANCE
REAL  IMAG.  REAL  IMAG.
1  1  1  2  1  5  -13.709  5.58248E+01 -2.06383E+01  1.82293E+01 -1.16438E+02

```

```

***** DATA CARD NO. 7 EN -0 -0 -0 -0 0. 0. 0. 0. 0. 0.
RUN TIME = 12.598

```

EXAMPLES 7 AND 8, SCATTERING BY A WIRE AND AIRCRAFT

Examples 7 and 8 demonstrate the use of NEC for scattering. The columns labeled "gain" are, in this case, scattering cross section in square wavelengths (σ/λ^2). Example 8 is a stick model of an aircraft as shown in figure 19.

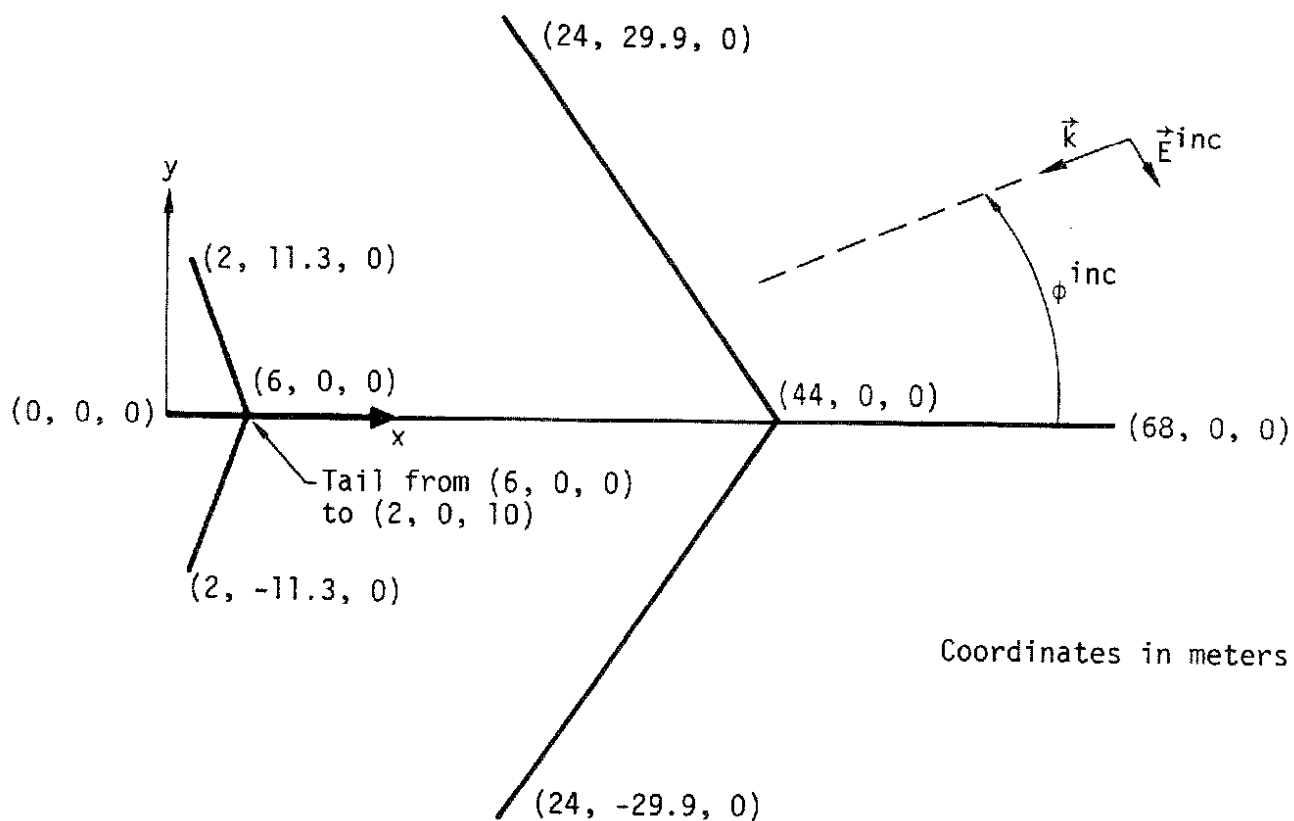

Figure 19. Stick model of aircraft.

Examples 7 and 8 Input

```

1
CMSAMPLE PROBLEMS FOR NEC - SCATTERING BY A WIRE.
CM 1. STRAIGHT WIRE - FREE SPACE
CM 2. STRAIGHT WIRE - PERFECT GROUND
CM 3. STRAIGHT WIRE - FINITELY CONDUCTING GROUND
CE (SIG.=1.E-4 MHOS/M., EPS.=6.)
GW 0 15 -55. 0. 10. 55. 0. 10. .01
GE 1
FR 0 1 0 0 3.
EX 1 2 1 0 0. 0. 0. 45. 0.
RP 0 2 1 1000 0. 0. 45. 0.
GN 1
EX 1 1 1 0 45. 0. 0.
RP 0 19 1 1000 90. 0. -10. 0.
GN 1 6. 1.000E-04
RP 0 19 1 1000 90. 0. -10. 0.
NX
CMSAMPLE PROBLEM FOR NEC
CESTICK MODEL OF AIRCRAFT - FREE SPACE
GW 1 1 0. 0. 0. 6. 0. 0. 1.
GW 2 6 6. 0. 0. 44. 0. 0. 1.
GW 3 4 44. 0. 0. 68. 0. 0. 1.
GW 4 6 44. 0. 0. 24. 29.9 0. 1.
GW 5 6 44. 0. 0. 24. -29.9 0. 1.
GW 6 2 6. 0. 0. 2. 11.3 0. 1.
GW 7 2 6. 0. 0. 2. -11.3 0. 1.
GW 8 2 6. 0. 0. 2. 0. 10. 1.
GE
FR 0 1 0 0 3.
EX 1 1 1 0 0. 0. 0.
RP 0 1 1 1000 0. 0. 0.
EX 1 1 1 0 90. 30. -90.
RP 0 1 1 1000 90. 30.
EN

```

Examples 7 and 8 Output

 NUMERICAL ELECTROMAGNETICS CODE

- - - COMMENTS - - -

SAMPLE PROBLEMS FOR NEC - SCATTERING BY A WIRE.
 1. STRAIGHT WIRE - FREE SPACE
 2. STRAIGHT WIRE - PERFECT GROUND
 3. STRAIGHT WIRE - FINITELY CONDUCTING GROUND
 (SIG.=1.E-4 MHOS/M., EPS.=6.)

- - - STRUCTURE SPECIFICATION - - -

COORDINATES MUST BE INPUT IN
 METERS OR BE SCALED TO METERS
 BEFORE STRUCTURE INPUT IS ENDED

WIRE NO.	X1	Y1	Z1	X2	Y2	Z2	RADIUS	NO. OF SEG.	FIRST SEG.	LAST SEG.	TAG NO.
1	-55.00000	0.	10.00000	55.00000	0.	10.00000	0.01000	15	1	15	0

GROUND PLANE SPECIFIED.

WHERE WIRE ENDS TOUCH GROUND, CURRENT WILL BE INTERPOLATED TO IMAGE IN GROUND PLANE.

TOTAL SEGMENTS USED= 15 NO. SEG. IN A SYMMETRIC CELL= 15 SYMMETRY FLAG= 0

- MULTIPLE WIRE JUNCTIONS -

JUNCTION SEGMENTS (- FOR END 1, + FOR END 2)
 NONE

- - - SEGMENTATION DATA - - -

COORDINATES IN METERS

I+ AND I- INDICATE THE SEGMENTS BEFORE AND AFTER I

SEG. NO.	COORDINATES OF SEG. CENTER	SEG. LENGTH	ORIENTATION ANGLES	WIRE RADIUS	CONNECTION DATA	TAG NO.
	X Y Z		ALPHA BETA		I- I I+	
1	-51.33333 0. 10.00000	7.33333	0. 0.	0.01000	0 1 2	0
2	-44.00000 0. 10.00000	7.33333	0. 0.	0.01000	1 2 3	0
3	-36.66667 0. 10.00000	7.33333	0. 0.	0.01000	2 3 4	0
4	-29.33333 0. 10.00000	7.33333	0. 0.	0.01000	3 4 5	0
5	-22.00000 0. 10.00000	7.33333	0. 0.	0.01000	4 5 6	0
6	-14.66667 0. 10.00000	7.33333	0. 0.	0.01000	5 6 7	0
7	-7.33333 0. 10.00000	7.33333	0. 0.	0.01000	6 7 8	0
8	-0.00000 0. 10.00000	7.33333	0. 0.	0.01000	7 8 9	0
9	7.33333 0. 10.00000	7.33333	0. 0.	0.01000	8 9 10	0
10	14.66667 0. 10.00000	7.33333	0. 0.	0.01000	9 10 11	0
11	22.00000 0. 10.00000	7.33333	0. 0.	0.01000	10 11 12	0
12	29.33333 0. 10.00000	7.33333	0. 0.	0.01000	11 12 13	0
13	36.66667 0. 10.00000	7.33333	0. 0.	0.01000	12 13 14	0
14	44.00000 0. 10.00000	7.33333	0. 0.	0.01000	13 14 15	0
15	51.33333 0. 10.00000	7.33333	0. 0.	0.01000	14 15 0	0

***** DATA CARD NO. 1 FR 0 1 0 0 3.00000E+00 0. 0. 0. 0. 0.
 ***** DATA CARD NO. 2 EX 1 2 1 0 0. 0. 0. 4.50000E+01 0. 0.
 ***** DATA CARD NO. 3 RP 0 2 1 1000 0. 0. 4.50000E+01 0. 0. 0.

----- FREQUENCY -----

FREQUENCY= 3.0000E+00 MHZ
 WAVELENGTH= 9.9933E+01 METERS

APPROXIMATE INTEGRATION EMPLOYED FOR SEGMENTS MORE THAN 1.000 WAVELENGTHS APART

--- STRUCTURE IMPEDANCE LOADING ---

THIS STRUCTURE IS NOT LOADED

--- ANTENNA ENVIRONMENT ---
 FREE SPACE

--- MATRIX TIMING ---

FILL= 0.083 SEC. FACTOR= 0.010 SEC.

--- EXCITATION ---

PLANE WAVE THETA= 0. DEG. PHI= 0. DEG. ETA= 0. DEG. TYPE -LINEAR= AXIAL RATIO=-0.

--- CURRENTS AND LOCATION ---

DISTANCES IN WAVELENGTHS

SEG. NO.	TAG NO.	COORD. OF SEG. CENTER			SEG. LENGTH	CURRENT (AMPS)			
		X	Y	Z		REAL	IMAG.	MAG.	PHASE
1	0	-0.5137	0.	0.1001	0.07338	-8.8823E-04	2.5672E-03	2.7165E-03	109.085
2	0	-0.4403	0.	0.1001	0.07338	1.5984E-03	2.1979E-03	2.7176E-03	53.975
3	0	-0.3669	0.	0.1001	0.07338	8.8156E-03	-4.2490E-03	9.7861E-03	-25.734
4	0	-0.2935	0.	0.1001	0.07338	1.9216E-02	-1.4937E-02	2.4338E-02	-37.859
5	0	-0.2201	0.	0.1001	0.07338	3.0734E-02	-2.7408E-02	4.1180E-02	-41.726
6	0	-0.1468	0.	0.1001	0.07338	4.1101E-02	-3.8922E-02	5.6605E-02	-43.440
7	0	-0.0734	0.	0.1001	0.07338	4.8271E-02	-4.6991E-02	6.7367E-02	-44.230
8	0	-0.0000	0.	0.1001	0.07338	5.0829E-02	-4.9887E-02	7.1220E-02	-44.464
9	0	0.0734	0.	0.1001	0.07338	4.8271E-02	-4.6991E-02	6.7367E-02	-44.230
10	0	0.1468	0.	0.1001	0.07338	4.1101E-02	-3.8922E-02	5.6605E-02	-43.440
11	0	0.2201	0.	0.1001	0.07338	3.0734E-02	-2.7408E-02	4.1180E-02	-41.726
12	0	0.2935	0.	0.1001	0.07338	1.9216E-02	-1.4937E-02	2.4338E-02	-37.859
13	0	0.3669	0.	0.1001	0.07338	8.8156E-03	-4.2490E-03	9.7861E-03	-25.734
14	0	0.4403	0.	0.1001	0.07338	1.5984E-03	2.1979E-03	2.7176E-03	53.975
15	0	0.5137	0.	0.1001	0.07338	-8.8823E-04	2.5672E-03	2.7165E-03	109.085

--- RADIATION PATTERNS ---

--- ANGLES ---		--- POWER GAINS ---			--- POLARIZATION ---			--- E(THETA) ---		--- E(PHI) ---	
THETA DEGREES	PHI DEGREES	VERT. DB	HOR. DB	TOTAL DB	AXIAL RATIO	TILT DEG.	SENSE	MAGNITUDE VOLTS/M	PHASE DEGREES	MAGNITUDE VOLTS/M	PHASE DEGREES
0.	0.	-12.86	-999.99	-12.86	0.	0.	LINEAR	6.41322E+00	-95.23	0.	0.
45.00	0.	-18.33	-999.99	-18.33	0.	0.	LINEAR	3.41557E+00	-108.66	0.	0.

--- EXCITATION ---

PLANE WAVE THETA= 45.00 DEG. PHI= 0. DEG. ETA= 0. DEG. TYPE -LINEAR= AXIAL RATIO=-0.

- - - CURRENTS AND LOCATION - - -

DISTANCES IN WAVELENGTHS

SEG. NO.	TAG NO.	COORD. OF SEG. CENTER			SEG. LENGTH	CURRENT (AMPS)			PHASE
		X	Y	Z		REAL	IMAG.	MAG.	
1	0	-0.5137	0.	0.1001	0.07338	-1.4018E-02	-2.6706E-02	3.0162E-02	-117.695
2	0	-0.4403	0.	0.1001	0.07338	-3.9114E-02	-6.9420E-02	7.9681E-02	-119.398
3	0	-0.3669	0.	0.1001	0.07338	-5.8271E-02	-9.6999E-02	1.1316E-01	-120.995
4	0	-0.2935	0.	0.1001	0.07338	-6.7872E-02	-1.0687E-01	1.2660E-01	-122.420
5	0	-0.2201	0.	0.1001	0.07338	-6.5359E-02	-9.8633E-02	1.1832E-01	-123.530
6	0	-0.1468	0.	0.1001	0.07338	-5.0273E-02	-7.4958E-02	9.0256E-02	-123.849
7	0	-0.0734	0.	0.1001	0.07338	-2.4528E-02	-4.1065E-02	4.7832E-02	-120.850
8	0	-0.0000	0.	0.1001	0.07338	7.8285E-03	-3.6791E-03	8.6499E-03	-25.172
9	0	0.0734	0.	0.1001	0.07338	4.1295E-02	3.0302E-02	5.1220E-02	36.271
10	0	0.1468	0.	0.1001	0.07338	6.9910E-02	5.5139E-02	8.9037E-02	38.263
11	0	0.2201	0.	0.1001	0.07338	8.8355E-02	6.7301E-02	1.1107E-01	37.297
12	0	0.2935	0.	0.1001	0.07338	9.2958E-02	6.6029E-02	1.1402E-01	35.386
13	0	0.3669	0.	0.1001	0.07338	8.2371E-02	5.3309E-02	9.8116E-02	32.910
14	0	0.4403	0.	0.1001	0.07338	5.7746E-02	3.3261E-02	6.6640E-02	29.941
15	0	0.5137	0.	0.1001	0.07338	2.1820E-02	1.0871E-02	2.4378E-02	26.483

- - - RADIATION PATTERNS - - -

- - ANGLES - -		- POWER GAINS -			- - - POLARIZATION - - -			- - - E(THETA) - - -		- - - E(PHI) - - -	
THETA DEGREES	PHI DEGREES	VERT. DB	HOR. DB	TOTAL DB	AXIAL RATIO	TILT DEG.	SENSE	MAGNITUDE VOLTS/M	PHASE DEGREES	MAGNITUDE VOLTS/M	PHASE DEGREES
0.	0.	-18.38	-999.99	-18.38	0.	0.	LINEAR	3.39892E+00	-108.66	0.	0.
45.00	0.	-10.40	-999.99	-10.40	0.	0.	LINEAR	8.51376E+00	71.99	0.	0.

***** DATA CARD NO.	4	GN	1	-0	-0	-0	0.	0.	0.	0.	0.	0.
***** DATA CARD NO.	5	EX	1	1	1	0	4.50000E+01	0.	0.	0.	0.	0.
***** DATA CARD NO.	6	RP	0	19	1	1000	9.00000E+01	0.	-1.00000E+01	0.	0.	0.

- - - STRUCTURE IMPEDANCE LOADING - - -

THIS STRUCTURE IS NOT LOADED

- - - ANTENNA ENVIRONMENT - - -
PERFECT GROUND

- - - MATRIX TIMING - - -

FILL= 0.142 SEC., FACTOR= 0.010 SEC.

- - - EXCITATION - - -

PLANE WAVE THETA= 45.00 DEG, PHI= 0. DEG, ETA= 0. DEG, TYPE -LINEAR= AXIAL RATIO=-0.

- - - CURRENTS AND LOCATION - - -

DISTANCES IN WAVELENGTHS

SEG. NO.	TAG NO.	COORD. OF SEG. CENTER			SEG. LENGTH	CURRENT (AMPS)			PHASE
		X	Y	Z		REAL	IMAG.	MAG.	
1	0	-0.5137	0.	0.1001	0.07338	9.6565E-03	-2.2201E-02	2.4211E-02	-66.493
2	0	-0.4403	0.	0.1001	0.07338	2.3189E-02	-6.0450E-02	6.4745E-02	-69.013
3	0	-0.3669	0.	0.1001	0.07338	2.9766E-02	-8.8238E-02	9.3124E-02	-71.359
4	0	-0.2935	0.	0.1001	0.07338	2.9989E-02	-1.0121E-01	1.0556E-01	-73.495
5	0	-0.2201	0.	0.1001	0.07338	2.5316E-02	-9.6764E-02	1.0002E-01	-75.338
6	0	-0.1468	0.	0.1001	0.07338	1.7998E-02	-7.5355E-02	7.7484E-02	-76.569
7	0	-0.0734	0.	0.1001	0.07338	1.0530E-02	-4.0581E-02	4.1925E-02	-75.454
8	0	-0.0000	0.	0.1001	0.07338	5.0481E-03	1.5152E-03	5.2706E-03	16.708
9	0	0.0734	0.	0.1001	0.07338	2.8275E-03	4.3477E-02	4.3569E-02	86.279

10	U	0.1468	0.	0.1001	0.07338	4.0010E-03	7.7881E-02	7.7984E-02	87.059
11	0	0.2201	0.	0.1001	0.07338	7.5610E-03	9.8725E-02	9.9014E-02	85.620
12	0	0.2935	0.	0.1001	0.07338	1.1639E-02	1.0254E-01	1.0320E-01	83.524
13	0	0.3669	0.	0.1001	0.07338	1.3996E-02	8.8979E-02	9.0073E-02	81.061
14	0	0.4403	0.	0.1001	0.07338	1.2582E-02	6.0735E-02	6.2024E-02	78.296
15	0	0.5137	0.	0.1001	0.07338	5.8541E-03	2.2237E-02	2.2994E-02	75.251

--- RADIATION PATTERNS ---

-- ANGLES --		- POWER GAINS -			- - - POLARIZATION - - -			- - - E(THETA) - - -		- - - E(PHI) - - -	
THETA	PHI	VERT.	HOR.	TOTAL	AXIAL	TILT	SENSE	MAGNITUDE	PHASE	MAGNITUDE	PHASE
DEGREES	DEGREES	DB	DB	DB	RATIO	DEG.		VOLTS/M	DEGREES	VOLTS/M	DEGREES
90.00	0.	-999.99	-999.99	-999.99	0.	0.		3.51915E-22	-175.50	0.	0.
80.00	0.	-36.78	-999.99	-36.78	0.	0.	LINEAR	4.08377E-01	-175.53	0.	0.
70.00	0.	-24.91	-999.99	-24.91	0.	0.	LINEAR	1.60223E+00	-175.47	0.	0.
60.00	0.	-18.29	-999.99	-18.29	0.	0.	LINEAR	3.43161E+00	-175.38	0.	0.
50.00	0.	-14.20	-999.99	-14.20	0.	0.	LINEAR	5.49963E+00	-175.26	0.	0.
40.00	0.	-12.00	-999.99	-12.00	0.	0.	LINEAR	7.08347E+00	-175.08	0.	0.
30.00	0.	-11.77	-999.99	-11.77	0.	0.	LINEAR	7.27018E+00	-174.81	0.	0.
20.00	0.	-14.39	-999.99	-14.39	0.	0.	LINEAR	5.37922E+00	-174.28	0.	0.
10.00	0.	-25.57	-999.99	-25.57	0.	0.	LINEAR	1.48512E+00	-170.99	0.	0.
0.	0.	-18.38	-999.99	-18.38	0.	0.	LINEAR	3.39530E+00	3.10	0.	0.
-10.00	0.	-11.31	-999.99	-11.31	0.	0.	LINEAR	7.66714E+00	4.34	0.	0.
-20.00	0.	-8.98	-999.99	-8.98	0.	0.	LINEAR	1.00250E+01	4.77	0.	0.
-30.00	0.	-8.95	-999.99	-8.95	0.	0.	LINEAR	1.00632E+01	5.06	0.	0.
-40.00	0.	-10.60	-999.99	-10.60	0.	0.	LINEAR	8.31601E+00	5.29	0.	0.
-50.00	0.	-13.78	-999.99	-13.78	0.	0.	LINEAR	5.77192E+00	5.49	0.	0.
-60.00	0.	-18.59	-999.99	-18.59	0.	0.	LINEAR	3.31792E+00	5.68	0.	0.
-70.00	0.	-25.71	-999.99	-25.71	0.	0.	LINEAR	1.46090E+00	5.83	0.	0.
-80.00	0.	-37.90	-999.99	-37.90	0.	0.	LINEAR	3.59178E-01	5.92	0.	0.
-90.00	0.	-999.99	-999.99	-999.99	0.	0.		3.05565E-22	5.99	0.	0.

***** DATA CARD NO. 7 GN -0 -0 -0 6.00000E+00 1.00000E-04 0. 0. 0. 0.
 ***** DATA CARD NO. 8 RP 0 19 1 1000 9.00000E+01 0. -1.00000E+01 0. 0. 0.

--- STRUCTURE IMPEDANCE LOADING ---

THIS STRUCTURE IS NOT LOADED

--- ANTENNA ENVIRONMENT ---

FINITE GROUND. REFLECTION COEFFICIENT APPROXIMATION
 RELATIVE DIELECTRIC CONST.= 6.000
 CONDUCTIVITY= 1.000E-04 MHOS/METER
 COMPLEX DIELECTRIC CONSTANT= 6.00000E+00-5.99200E-01

--- MATRIX TIMING ---

FILL= 0.154 SEC., FACTOR= 0.010 SEC.

--- EXCITATION ---

PLANE WAVE THETA= 45.00 DEG, PHI= 0. DEG, ETA= 0. DEG, TYPE -LINEAR= AXIAL RATIO=-0.

--- CURRENTS AND LOCATION ---

DISTANCES IN WAVELENGTHS

SEG. NO.	TAG NO.	COORD. OF		SEG. CENTER	SEG. LENGTH	- - - CURRENT (AMPS) - - -			
		X	Y			Z	REAL	IMAG.	MAG.
1	0	-0.5137	0.	0.1001	0.07338	-7.4247E-03	-2.3607E-02	2.4747E-02	-107.459
2	0	-0.4403	0.	0.1001	0.07338	-2.1836E-02	-6.1962E-02	6.5697E-02	-109.413
3	0	-0.3669	0.	0.1001	0.07338	-3.3971E-02	-8.7376E-02	9.3748E-02	-111.245

4	0	-0.2935	0.	0.1001	0.07338	-4.1013E-02	-9.7068E-02	1.0538E-01	-112.905
5	0	-0.2201	0.	0.1001	0.07338	-4.0667E-02	-9.0199E-02	9.8942E-02	-114.268
6	0	-0.1468	0.	0.1001	0.07338	-3.1928E-02	-6.8766E-02	7.5817E-02	-114.905
7	0	-0.0734	0.	0.1001	0.07338	-1.5433E-02	-3.7267E-02	4.0336E-02	-112.496
8	0	-0.0000	0.	0.1001	0.07338	6.5278E-03	-1.8009E-03	6.7717E-03	-15.423
9	0	0.0734	0.	0.1001	0.07338	3.0350E-02	3.1125E-02	4.3473E-02	45.723
10	0	0.1468	0.	0.1001	0.07338	5.1732E-02	5.5859E-02	7.6134E-02	47.197
11	0	0.2201	0.	0.1001	0.07338	6.6473E-02	6.8652E-02	9.5561E-02	45.924
12	0	0.2935	0.	0.1001	0.07338	7.1286E-02	6.8296E-02	9.8722E-02	43.773
13	0	0.3669	0.	0.1001	0.07338	6.4446E-02	5.6217E-02	8.5520E-02	41.099
14	0	0.4403	0.	0.1001	0.07338	4.6116E-02	3.6001E-02	5.8504E-02	37.978
15	0	0.5137	0.	0.1001	0.07338	1.7790E-02	1.2195E-02	2.1568E-02	34.432

--- RADIATION PATTERNS ---

-- ANGLES --		- POWER GAINS -			POLARIZATION - - -			- - - E (THETA)		- - - E (PHI) - - -	
THETA	PHI	VERT.	HOR.	TOTAL	AXIAL	TILT	SENSE	MAGNITUDE	PHASE	MAGNITUDE	PHASE
DEGREES	DEGREES	DB	DB	DB	RATIO	DEG.		VOLTS/M	DEGREES	VOLTS/M	DEGREES
90.00	0.	-999.99	-999.99	-999.99	0.	0.		1.06260E-10	-125.89	0.	0.
80.00	0.	-21.13	-999.99	-21.13	0.	0.	LINEAR	2.47653E+00	57.80	0.	0.
70.00	0.	-17.33	-999.99	-17.33	0.	0.	LINEAR	3.83340E+00	66.56	0.	0.
60.00	0.	-15.22	-999.99	-15.22	0.	0.	LINEAR	4.89061E+00	78.65	0.	0.
50.00	0.	-13.63	-999.99	-13.63	0.	0.	LINEAR	5.86890E+00	91.02	0.	0.
40.00	0.	-12.74	-999.99	-12.74	0.	0.	LINEAR	6.50031E+00	101.35	0.	0.
30.00	0.	-13.18	-999.99	-13.18	0.	0.	LINEAR	6.17974E+00	109.14	0.	0.
20.00	0.	-16.17	-999.99	-16.17	0.	0.	LINEAR	4.38120E+00	115.33	0.	0.
10.00	0.	-27.81	-999.99	-27.81	0.	0.	LINEAR	1.14676E+00	129.38	0.	0.
0.	0.	-19.82	-999.99	-19.82	0.	0.	LINEAR	2.87841E+00	-70.02	0.	0.
-10.00	0.	-12.92	-999.99	-12.92	0.	0.	LINEAR	6.36849E+00	-67.00	0.	0.
-20.00	0.	-10.50	-999.99	-10.50	0.	0.	LINEAR	8.41416E+00	-68.17	0.	0.
-30.00	0.	-10.18	-999.99	-10.18	0.	0.	LINEAR	8.73340E+00	-71.81	0.	0.
-40.00	0.	-11.20	-999.99	-11.20	0.	0.	LINEAR	7.76343E+00	-78.11	0.	0.
-50.00	0.	-13.08	-999.99	-13.08	0.	0.	LINEAR	6.25598E+00	-87.34	0.	0.
-60.00	0.	-15.38	-999.99	-15.38	0.	0.	LINEAR	4.79950E+00	-98.85	0.	0.
-70.00	0.	-18.01	-999.99	-18.01	0.	0.	LINEAR	3.54703E+00	-110.27	0.	0.
-80.00	0.	-22.11	-999.99	-22.11	0.	0.	LINEAR	2.21045E+00	-118.60	0.	0.
-90.00	0.	-999.99	-999.99	-999.99	0.	0.		9.36921E-11	57.85	0.	0.

***** DATA CARD NO. 9 NX -0 -0 -0 -0 0. 0. 0. 0. 0. 0.

NUMERICAL ELECTROMAGNETICS CODE

 COMMENTS

SAMPLE PROBLEM FOR NEC
 STICK MODEL OF AIRCRAFT - FREE SPACE

 STRUCTURE SPECIFICATION

COORDINATES MUST BE INPUT IN
 METERS OR BE SCALED TO METERS
 BEFORE STRUCTURE INPUT IS ENDED

WIRE NO.	X1	Y1	Z1	X2	Y2	Z2	RADIUS	NO. OF SEG.	FIRST SEG.	LAST SEG.	TAG NO.
1	0.	0.	0.	6.00000	0.	0.	1.00000	1	1	1	1
2	6.00000	0.	0.	44.00000	0.	0.	1.00000	6	2	7	2
3	44.00000	0.	0.	68.00000	0.	0.	1.00000	4	8	11	3
4	44.00000	0.	0.	24.00000	29.90000	0.	1.00000	6	12	17	4
5	44.00000	0.	0.	24.00000	-29.90000	0.	1.00000	6	18	23	5
6	6.00000	0.	0.	2.00000	11.30000	0.	1.00000	2	24	25	6
7	6.00000	0.	0.	2.00000	-11.30000	0.	1.00000	2	26	27	7
8	6.00000	0.	0.	2.00000	0.	10.00000	1.00000	2	28	29	8

TOTAL SEGMENTS USED= 29 NO. SEG. IN A SYMMETRIC CELL= 29 SYMMETRY FLAG= 0

MULTIPLE WIRE JUNCTIONS -
 JUNCTION SEGMENTS 1- FOR END 1, + FOR END 2)

1	1	-2	-24	-26	-28
2	7	-8	-12	-18	

 SEGMENTATION DATA

COORDINATES IN METERS

1+ AND 1- INDICATE THE SEGMENTS BEFORE AND AFTER 1

SEG. NO.	COORDINATES OF CENTER	SEG. LENGTH	ORIENTATION ANGLES	WIRE RADIUS	CONNECTION DATA	TAG NO.
	X Y Z		ALPHA BETA		1- 1 1+	
1	3.00000 0. 0.	6.00000	0. 0.	1.00000	0 1 2	1
2	9.16667 0. 0.	6.33333	0. 0.	1.00000	-24 2 3	2
3	15.50000 0. 0.	6.33333	0. 0.	1.00000	2 3 4	2
4	21.83333 0. 0.	6.33333	0. 0.	1.00000	3 4 5	2
5	28.16667 0. 0.	6.33333	0. 0.	1.00000	4 5 6	2
6	34.50000 0. 0.	6.33333	0. 0.	1.00000	5 6 7	2
7	40.83333 0. 0.	6.33333	0. 0.	1.00000	6 7 8	2
8	47.00000 0. 0.	6.00000	0. 0.	1.00000	-12 8 9	3
9	53.00000 0. 0.	6.00000	0. 0.	1.00000	8 9 10	3
10	59.00000 0. 0.	6.00000	0. 0.	1.00000	9 10 11	3
11	65.00000 0. 0.	6.00000	0. 0.	1.00000	10 11 0	3
12	42.33333 2.49167 0.	5.99539	0. 123.77842	1.00000	-18 12 13	4
13	39.00000 7.47500 0.	5.99539	0. 123.77842	1.00000	12 13 14	4
14	35.66667 12.45833 0.	5.99539	0. 123.77842	1.00000	13 14 15	4
15	32.33333 17.44167 0.	5.99539	0. 123.77842	1.00000	14 15 16	4
16	29.00000 22.42500 0.	5.99539	0. 123.77842	1.00000	15 16 17	4
17	25.66667 27.40833 0.	5.99539	0. 123.77842	1.00000	16 17 0	4
18	42.33333 -2.49167 0.	5.99539	0. -123.77842	1.00000	7 18 19	5
19	39.00000 -7.47500 0.	5.99539	0. -123.77842	1.00000	18 19 20	5
20	35.66667 -12.45833 0.	5.99539	0. -123.77842	1.00000	19 20 21	5
21	32.33333 -17.44167 0.	5.99539	0. -123.77842	1.00000	20 21 22	5
22	29.00000 -22.42500 0.	5.99539	0. -123.77842	1.00000	21 22 23	5
23	25.66667 -27.40833 0.	5.99539	0. -123.77842	1.00000	22 23 0	5
24	5.00000 2.82500 0.	5.99354	0. 109.49306	1.00000	-26 24 25	6
25	3.00000 8.47500 0.	5.99354	0. 109.49306	1.00000	24 25 0	6
26	5.00000 -2.82500 0.	5.99354	0. -109.49306	1.00000	-28 26 27	7
27	3.00000 -8.47500 0.	5.99354	0. -109.49306	1.00000	26 27 0	7
28	5.00000 0. 2.50000	5.38516	68.19859 180.00000	1.00000	1 28 29	8
29	3.00000 0. 7.50000	5.38516	68.19859 180.00000	1.00000	28 29 0	8

```

***** DATA CARD NO. 1  FR 0 1 0 0 3.00000E+00 0. 0. 0. 0.
***** DATA CARD NO. 2  EX 1 1 1 0 0. 0. 0. 0. 0.
***** DATA CARD NO. 3  RP 0 1 1 1000 0. 0. 0. 0. 0.

```

- - - - - FREQUENCY - - - - -

FREQUENCY= 3.0000E+00 MHZ
WAVELENGTH= 9.9933E+01 METERS

APPROXIMATE INTEGRATION EMPLOYED FOR SEGMENTS MORE THAN 1.000 WAVELENGTHS APART

- - - STRUCTURE (IMPEDANCE LOADING) - - -

THIS STRUCTURE IS NOT LOADED

- - - ANTENNA ENVIRONMENT - - -
FREE SPACE

- - - MATRIX TIMING - - -

FILL= 0.200 SEC., FACTOR= 0.062 SEC.

- - - EXCITATION - - -

PLANE WAVE THETA= 0. DEG, PHI= 0. DEG, ETA= 0. DEG, TYPE -LINEAR= AXIAL RATIO=-0.

- - - CURRENTS AND LOCATION - - -

DISTANCES IN WAVELENGTHS

SEG. NO.	TAG NO.	COORD. OF SEG. CENTER			SEG. LENGTH	- - - CURRENT (AMPS) - - -			PHASE
		X	Y	Z		REAL	IMAG.	MAG.	
1	1	0.0300	0.	0.	0.06004	1.4997E-03	4.6949E-03	4.9287E-03	72.285
2	2	0.0917	0.	0.	0.06338	3.2096E-02	-1.7022E-02	3.6331E-02	-27.938
3	2	0.1551	0.	0.	0.06338	3.7966E-02	-3.1078E-02	4.9064E-02	-39.303
4	2	0.2185	0.	0.	0.06338	4.4299E-02	-4.9460E-02	6.6398E-02	-48.151
5	2	0.2819	0.	0.	0.06338	4.9342E-02	-6.7069E-02	8.3264E-02	-53.658
6	2	0.3452	0.	0.	0.06338	5.2034E-02	-7.9829E-02	9.5290E-02	-56.903
7	2	0.4086	0.	0.	0.06338	5.1637E-02	-8.4841E-02	9.9320E-02	-58.674
8	3	0.4703	0.	0.	0.06004	2.0877E-01	-2.0895E-01	2.9537E-01	-45.024
9	3	0.5304	0.	0.	0.06004	1.7844E-01	-1.7850E-01	2.5239E-01	-45.010
10	3	0.5904	0.	0.	0.06004	1.2813E-01	-1.2752E-01	1.8077E-01	-44.865
11	3	0.6504	0.	0.	0.06004	5.9205E-02	-5.8276E-02	8.3074E-02	-44.547
12	4	0.4236	0.0249	0.	0.05999	-8.3233E-02	6.6192E-02	1.0634E-01	141.506
13	4	0.3903	0.0748	0.	0.05999	-8.3106E-02	6.5612E-02	1.0588E-01	141.709
14	4	0.3569	0.1247	0.	0.05999	-7.6169E-02	5.8726E-02	9.6179E-02	142.368
15	4	0.3235	0.1745	0.	0.05999	-6.2519E-02	4.6263E-02	7.7774E-02	143.499
16	4	0.2902	0.2244	0.	0.05999	-4.3490E-02	3.0212E-02	5.2955E-02	145.213
17	4	0.2568	0.2743	0.	0.05999	-1.9544E-02	1.2376E-02	2.3133E-02	147.657
18	5	0.4236	-0.0249	0.	0.05999	-8.3233E-02	6.6192E-02	1.0634E-01	141.506
19	5	0.3903	-0.0748	0.	0.05999	-8.3106E-02	6.5612E-02	1.0588E-01	141.709
20	5	0.3569	-0.1247	0.	0.05999	-7.6169E-02	5.8726E-02	9.6179E-02	142.368
21	5	0.3235	-0.1745	0.	0.05999	-6.2519E-02	4.6263E-02	7.7774E-02	143.499
22	5	0.2902	-0.2244	0.	0.05999	-4.3490E-02	3.0212E-02	5.2955E-02	145.213
23	5	0.2568	-0.2743	0.	0.05999	-1.9544E-02	1.2376E-02	2.3133E-02	147.657
24	6	0.0500	0.0283	0.	0.05998	-1.0118E-02	5.2353E-03	1.1392E-02	152.642
25	6	0.0300	0.0848	0.	0.05998	-4.6176E-03	1.7836E-03	4.9501E-03	158.880
26	7	0.0500	-0.0283	0.	0.05998	-1.0118E-02	5.2353E-03	1.1392E-02	152.642
27	7	0.0300	-0.0848	0.	0.05998	-4.6176E-03	1.7836E-03	4.9501E-03	158.880
28	8	0.0500	0.	0.0250	0.05389	-5.2940E-03	5.3450E-03	7.5230E-03	134.725
29	8	0.0300	0.	0.0751	0.05389	-1.5853E-03	2.0518E-03	2.5929E-03	127.691

- - - RADIATION PATTERNS - - -

- - ANGLES - -		- POWER GAINS -			- - - POLARIZATION - - -			- - - E(THETA) - - -		- - - E(PHI) - - -	
THETA	PHI	VERT.	HOR.	TOTAL	AXIAL	TILT	SENSE	MAGNITUDE	PHASE	MAGNITUDE	PHASE
DEGREES	DEGREES	DB	DB	DB	RATIO	DEG.		VOLTS/M	DEGREES	VOLTS/M	DEGREES
0.	0.	-2.98	-999.99	-2.98	0.00000	-0.00	LINEAR	2.00020E+01	-133.97	1.07231E-12	69.59

***** DATA CARD NO. 4 EX 1 1 1 0 9 00000E+01 3.00000E+01 -9.00000E+01 0. 0. 0.
 ***** DATA CARD NO. 5 RP 0 1 1 1000 9 00000E+01 3.00000E+01 0. 0. 0. 0.

- - - EXCITATION - - -

PLANE WAVE THETA= 90.00 DEG. PHI= 30.00 DEG. ETA= -90.00 DEG. TYPE -LINEAR= AXIAL RATIO=-0.

- - - CURRENTS AND LOCATION - - -

DISTANCES IN WAVELENGTHS

SEG. NO.	TAG NO.	COORD. OF SEG. CENTER			SEG. LENGTH	- - - CURRENT (AMPS) - - -			
		X	Y	Z		REAL	IMAG.	MAG.	PHASE
1	1	0.0300	0.	0.	0.06004	2.1952E-03	3.6163E-03	4.2304E-03	58.741
2	2	0.0917	0.	0.	0.06338	6.5450E-03	3.5228E-03	7.4328E-03	28.291
3	2	0.1551	0.	0.	0.06338	7.4391E-03	-5.7724E-03	9.4160E-03	-37.810
4	2	0.2185	0.	0.	0.06338	9.8857E-03	-1.9791E-02	2.2123E-02	-63.458
5	2	0.2819	0.	0.	0.06338	1.4293E-02	-3.5271E-02	3.8057E-02	-67.941
6	2	0.3452	0.	0.	0.06338	2.0095E-02	-4.8858E-02	5.2829E-02	-67.544
7	2	0.4086	0.	0.	0.06338	2.5574E-02	-5.7700E-02	6.3113E-02	-66.096
8	3	0.4703	0.	0.	0.06004	-3.8610E-02	1.5511E-01	1.5984E-01	103.978
9	3	0.5304	0.	0.	0.06004	-2.7543E-02	1.3176E-01	1.3461E-01	101.807
10	3	0.5904	0.	0.	0.06004	-1.4291E-02	9.3989E-02	9.5069E-02	98.645
11	3	0.6504	0.	0.	0.06004	-3.4931E-03	4.3257E-02	4.3398E-02	94.617
12	4	0.4236	0.0249	0.	0.05999	-2.3663E-02	-2.1177E-01	2.1309E-01	-96.376
13	4	0.3903	0.0748	0.	0.05999	-1.6402E-02	-2.0488E-01	2.0554E-01	-94.577
14	4	0.3569	0.1247	0.	0.05999	-7.9414E-03	-1.8318E-01	1.8335E-01	-92.482
15	4	0.3235	0.1745	0.	0.05999	-3.7454E-04	-1.4723E-01	1.4723E-01	-90.146
16	4	0.2902	0.2244	0.	0.05999	4.5370E-03	-1.0032E-01	1.0042E-01	-87.411
17	4	0.2568	0.2743	0.	0.05999	4.5311E-03	-4.4057E-02	4.4290E-02	-84.128
18	5	0.4236	-0.0249	0.	0.05999	9.4628E-02	-8.9035E-03	9.5046E-02	-5.375
19	5	0.3903	-0.0748	0.	0.05999	9.3142E-02	-9.9663E-03	9.3673E-02	-6.107
20	5	0.3569	-0.1247	0.	0.05999	8.5086E-02	-7.7993E-03	8.5443E-02	-5.237
21	5	0.3235	-0.1745	0.	0.05999	7.0545E-02	-3.6568E-03	7.0640E-02	-2.967
22	5	0.2902	-0.2244	0.	0.05999	5.0363E-02	3.7762E-04	5.0365E-02	0.430
23	5	0.2568	-0.2743	0.	0.05999	2.3641E-02	1.8773E-03	2.3715E-02	4.540
24	6	0.0500	0.0283	0.	0.05998	1.1756E-02	-3.7554E-02	3.9351E-02	-72.617
25	6	0.0300	0.0848	0.	0.05998	7.3150E-03	-2.2549E-02	2.3705E-02	-72.026
26	7	0.0500	-0.0283	0.	0.05998	-1.0447E-02	3.6781E-02	3.8236E-02	105.856
27	7	0.0300	-0.0848	0.	0.05998	-4.9516E-03	2.0995E-02	2.1571E-02	103.270
28	8	0.0500	0.	0.0250	0.05389	-4.6028E-03	-1.6751E-03	4.8981E-03	-160.002
29	8	0.0300	0.	0.0751	0.05389	-2.6266E-03	-1.6650E-03	3.1098E-03	-147.630

- - - RADIATION PATTERNS - - -

- - ANGLES - -		- POWER GAINS -			- - - POLARIZATION - - -			- - - E(THETA) - - -		- - - E(PHI) - - -	
THETA	PHI	VERT.	HOR.	TOTAL	AXIAL	TILT	SENSE	MAGNITUDE	PHASE	MAGNITUDE	PHASE
DEGREES	DEGREES	DB	DB	DB	RATIO	DEG.		VOLTS/M	DEGREES	VOLTS/M	DEGREES
90.00	30.00	-51.77	-9.79	-9.79	0.00010	89.54	RIGHT	7.27505E-02	-52.30	9.13416E+00	-52.98

***** DATA CARD NO. 6 EN -0 -0 -0 -0 0. 0. 0. 0. 0. 0. 0.

RUN TIME = 1.271

EXAMPLE 9, SCATTERING BY A SPHERE

Example 9 shows scattering by a sphere with ka of 2.9 (ka = circumference/wavelength). Bistatic scattering patterns are computed in the E and H planes, followed by near E and H field. The near fields within the sphere should be the negative of the incident field to produce zero total field. This condition is approximately satisfied in the example.

If the frequency is changed to $ka = 2.744$, however, large internal fields will exist in the TM_{101} mode of the spherical cavity which is resonant at this ka . Such internal resonances may occur in any closed structure and result in severe errors. The errors may be avoided by placing wires inside the sphere to destroy the resonance condition at a given frequency. Since the magnetic field integral equation enforces zero tangential magnetic field on the inside of the surface, the surface acts as a perfect magnetic conductor on the inside. Hence, the resonant fields are the dual of those that would exist in a perfect electric conductor. Unfortunately, while the correct magnetic currents for the internal fields would not radiate externally, the electric currents radiate strongly.

Example 9 Input

```

1
CMBISTATIC SCATTERING BY A SPHERE.
CMPATCH DATA ARE INPUT FOR A SPHERE OF 1. M. RADIUS
CMTHE SPHERE IS THEN SCALED SO THAT KA=FREQUENCY IN MHZ.
CMTHE PATCH MODEL MAY BE USED FOR KA LESS THAN ABOUT 3.
CEFOR THIS RUN *** KA=2.9 ***
SP      .13795      .13795      .98079      78.75      45.      .11957
SP      .51328      .21261      .83147      56.25      22.5     .17025
SP      .21261      .51328      .83147      56.25      67.5     .17025
SP      .80314      .21520      .55557      33.75      15.      .16987
SP      .58794      .58794      .55557      33.75      45.      .16987
SP      .21520      .80314      .55557      33.75      75.      .16987
SP      .96194      .19134      .19509      11.25      11.25    .15028
SP      .81549      .54490      .19509      11.25      33.75    .15028
SP      .54490      .81549      .19509      11.25      56.25    .15028
SP      .19134      .96194      .19509      11.25      78.75    .15028
GX      111
GS      47.71465
CE
FR      1
EX 1 1 1 0 90. 0. 0.
RP 0 19 1 1000 90. 0. -10. 0.
RP 0 1 19 1000 90. 0. 0. 10.
NE 0 1 1 1 0. 0. 0. 0. 5.
NE 0 1 11 1 0. 0. 0. 0. 5. 0.
NE 0 11 1 1 0. 0. 0. 5. 0. 0.
NH 0 1 1 11 0. 0. 0. 0. 0. 5.
NH 0 1 11 1 0. 0. 0. 0. 5. 0.
NH 0 11 1 1 0. 0. 0. 5. 0. 0.
EN

```

Example 9 Output

 NUMERICAL ELECTROMAGNETICS CODE

- - - COMMENTS - - -

BISTATIC SCATTERING BY A SPHERE.
 PATCH DATA ARE INPUT FOR A SPHERE OF 1. M. RADIUS
 THE SPHERE IS THEN SCALED SO THAT KA=FREQUENCY IN MHZ.
 THE PATCH MODEL MAY BE USED FOR KA LESS THAN ABOUT 3.
 FOR THIS RUN *** KA=2.9 ***

- - - STRUCTURE SPECIFICATION - - -

COORDINATES MUST BE INPUT IN
 METERS OR BE SCALED TO METERS
 BEFORE STRUCTURE INPUT IS ENDED

WIRE NO.	X1	Y1	Z1	X2	Y2	Z2	NO. OF RADIUS	FIRST SEG.	LAST SEG.	TAG NO.
1P	0.13795	0.13795	0.98079	78.75000	45.00000	0.11957				
2P	0.51328	0.21261	0.83147	56.25000	22.50000	0.17025				
3P	0.21261	0.51328	0.83147	56.25000	67.50000	0.17025				
4P	0.80314	0.21520	0.55557	33.75000	15.00000	0.16987				
5P	0.58794	0.58794	0.55557	33.75000	45.00000	0.16987				
6P	0.21520	0.80314	0.55557	33.75000	75.00000	0.16987				
7P	0.96194	0.19134	0.19509	11.25000	11.25000	0.15028				
8P	0.81549	0.54490	0.19509	11.25000	33.75000	0.15028				
9P	0.54490	0.81549	0.19509	11.25000	56.25000	0.15028				
10P	0.19134	0.96194	0.19509	11.25000	78.75000	0.15028				

STRUCTURE REFLECTED ALONG THE AXES X Y Z. TAGS INCREMENTED BY -0
 STRUCTURE SCALED BY FACTOR 47.71465

TOTAL SEGMENTS USED= 0 NO. SEG. IN A SYMMETRIC CELL= 0 SYMMETRY FLAG= 2
 TOTAL PATCHES USED= 80 NO. PATCHES IN A SYMMETRIC CELL= 10
 STRUCTURE HAS 3 PLANES OF SYMMETRY

- - - SURFACE PATCH DATA - - -

COORDINATES IN METERS

PATCH NO.	COORD. OF PATCH CENTER			UNIT NORMAL VECTOR			PATCH AREA	COMPONENTS OF UNIT TANGENT VECTORS					
	X	Y	Z	X	Y	Z		X1	Y1	Z1	X2	Y2	Z2
1	6.58224	6.58224	46.79805	0.1379	0.1379	0.9808	272.22356	0.7071	0.7071	0.	-0.6935	-0.6935	0.1951
2	24.49098	10.14461	39.67330	0.5133	0.2126	0.8315	387.60610	-0.3827	0.9239	0.	-0.7682	-0.3182	0.5556
3	10.14461	24.49098	39.67330	0.2126	0.5133	0.8315	387.60610	-0.9239	0.3827	0.	-0.3182	-0.7682	0.5556
4	38.32154	10.26819	26.50883	0.8031	0.2152	0.5556	386.74096	-0.2588	0.9659	0.	-0.5366	-0.1438	0.8315
5	28.05335	28.05335	26.50883	0.5879	0.5879	0.5556	386.74096	-0.7071	0.7071	0.	-0.3928	-0.3928	0.8315
6	10.26819	38.32154	26.50883	0.2152	0.8031	0.5556	386.74096	-0.9659	0.2588	0.	-0.1438	-0.5366	0.8315
7	45.89863	9.12972	9.30865	0.9619	0.1913	0.1951	342.14065	-0.1951	0.9808	0.	-0.1913	-0.0381	0.9808
8	38.91082	25.99971	9.30865	0.8155	0.5449	0.1951	342.14065	-0.5556	0.8315	0.	-0.1622	-0.1084	0.9808
9	25.99971	38.91082	9.30865	0.5449	0.8155	0.1951	342.14065	-0.8315	0.5556	0.	-0.1084	-0.1622	0.9808
10	9.12972	45.89863	9.30865	0.1913	0.9619	0.1951	342.14065	-0.9808	0.1951	0.	-0.0381	-0.1913	0.9808
11	6.58224	6.58224	-46.79805	0.1379	0.1379	-0.9808	272.22356	-0.7071	0.7071	-0.	-0.6935	-0.6935	-0.1951
12	24.49098	10.14461	-39.67330	0.5133	0.2126	-0.8315	387.60610	-0.3827	0.9239	-0.	-0.7682	-0.3182	-0.5556
13	10.14461	24.49098	-39.67330	0.2126	0.5133	-0.8315	387.60610	-0.9239	0.3827	-0.	-0.3182	-0.7682	-0.5556
14	38.32154	10.26819	-26.50883	0.8031	0.2152	-0.5556	386.74096	-0.2588	0.9659	-0.	-0.5366	-0.1438	-0.8315
15	28.05335	28.05335	-26.50883	0.5879	0.5879	-0.5556	386.74096	-0.7071	0.7071	-0.	-0.3928	-0.3928	-0.8315
16	10.26819	38.32154	-26.50883	0.2152	0.8031	-0.5556	386.74096	-0.9659	0.2588	-0.	-0.1438	-0.5366	-0.8315
17	45.89863	9.12972	-9.30865	0.9619	0.1913	-0.1951	342.14065	-0.1951	0.9808	-0.	-0.1913	-0.0381	-0.9808
18	38.91082	25.99971	-9.30865	0.8155	0.5449	-0.1951	342.14065	-0.5556	0.8315	-0.	-0.1622	-0.1084	-0.9808
19	25.99971	38.91082	-9.30865	0.5449	0.8155	-0.1951	342.14065	-0.8315	0.5556	-0.	-0.1084	-0.1622	-0.9808
20	9.12972	45.89863	-9.30865	0.1913	0.9619	-0.1951	342.14065	-0.9808	0.1951	-0.	-0.0381	-0.1913	-0.9808
21	6.58224	-6.58224	46.79805	0.1379	-0.1379	0.9808	272.22356	-0.7071	-0.7071	0.	-0.6935	0.6935	0.1951

22	24.49098	-10.14461	39.67330	0.5133	-0.2126	0.8315	387.60610	-0.3827	-0.9239	0.	-0.7682	0.3182	0.5556
23	10.14461	-24.49098	39.67330	0.2126	-0.5133	0.8315	387.60610	-0.9239	-0.3827	0.	-0.3182	0.7682	0.5556
24	38.32154	-10.26819	26.50883	0.8031	-0.2152	0.5556	386.74096	-0.2588	-0.9659	0.	-0.5366	0.1438	0.8315
25	28.05335	-28.05335	26.50883	0.5879	-0.5879	0.5556	386.74096	-0.7071	-0.7071	0.	-0.3928	0.3928	0.8315
26	10.26819	-38.32154	26.50883	0.2152	-0.8031	0.5556	386.74096	-0.9659	-0.2588	0.	-0.1438	0.5366	0.8315
27	45.89863	-9.12972	9.30865	0.9619	-0.1913	0.1951	342.14065	-0.1951	-0.9808	0.	-0.1913	0.0381	0.9808
28	38.91082	-25.99971	9.30865	0.8155	-0.5449	0.1951	342.14065	-0.5556	-0.8315	0.	-0.1622	0.1084	0.9808
29	25.99971	-38.91082	9.30865	0.5449	-0.8155	0.1951	342.14065	-0.8315	-0.5556	0.	-0.1084	0.1622	0.9808
30	9.12972	-45.89863	9.30865	0.1913	-0.9619	0.1951	342.14065	-0.9808	-0.1951	0.	-0.0381	0.1913	0.9808
31	6.58224	-6.58224	-46.79805	0.1379	-0.1379	-0.9808	272.22356	-0.7071	-0.7071	-0.	-0.6935	0.6935	-0.1951
32	24.49098	-10.14461	-39.67330	0.5133	-0.2126	-0.8315	387.60610	-0.3827	-0.9239	-0.	-0.7682	0.3182	-0.5556
33	10.14461	-24.49098	-39.67330	0.2126	-0.5133	-0.8315	387.60610	-0.9239	-0.3827	-0.	-0.3182	0.7682	-0.5556
34	38.32154	-10.26819	-26.50883	0.8031	-0.2152	-0.5556	386.74096	-0.2588	-0.9659	-0.	-0.5366	0.1438	-0.8315
35	28.05335	-28.05335	-26.50883	0.5879	-0.5879	-0.5556	386.74096	-0.7071	-0.7071	-0.	-0.3928	0.3928	-0.8315
36	10.26819	-38.32154	-26.50883	0.2152	-0.8031	-0.5556	386.74096	-0.9659	-0.2588	-0.	-0.1438	0.5366	-0.8315
37	45.89863	-9.12972	-9.30865	0.9619	-0.1913	-0.1951	342.14065	-0.1951	-0.9808	-0.	-0.1913	0.0381	-0.9808
38	38.91082	-25.99971	-9.30865	0.8155	-0.5449	-0.1951	342.14065	-0.5556	-0.8315	-0.	-0.1622	0.1084	-0.9808
39	25.99971	-38.91082	-9.30865	0.5449	-0.8155	-0.1951	342.14065	-0.8315	-0.5556	-0.	-0.1084	0.1622	-0.9808
40	9.12972	-45.89863	-9.30865	0.1913	-0.9619	-0.1951	342.14065	-0.9808	-0.1951	-0.	-0.0381	0.1913	-0.9808
41	-6.58224	6.58224	46.79805	-0.1379	0.1379	0.9808	272.22356	0.7071	0.7071	0.	0.6935	-0.6935	0.1951
42	-24.49098	10.14461	39.67330	-0.5133	0.2126	0.8315	387.60610	0.3827	0.9239	0.	0.7682	-0.3182	0.5556
43	-10.14461	24.49098	39.67330	-0.2126	0.5133	0.8315	387.60610	0.9239	0.3827	0.	0.3182	-0.7682	0.5556
44	-38.32154	10.26819	26.50883	-0.8031	0.2152	0.5556	386.74096	0.2588	0.9659	0.	0.5366	-0.1438	0.8315
45	-28.05335	28.05335	26.50883	-0.5879	0.5879	0.5556	386.74096	0.7071	0.7071	0.	0.3928	-0.3928	0.8315
46	-10.26819	38.32154	26.50883	-0.2152	0.8031	0.5556	386.74096	0.9659	0.2588	0.	0.1438	-0.5366	0.8315
47	-45.89863	9.12972	9.30865	-0.9619	0.1913	0.1951	342.14065	0.1951	0.9808	0.	0.1913	-0.0381	0.9808
48	-38.91082	25.99971	9.30865	-0.8155	0.5449	0.1951	342.14065	0.5556	0.8315	0.	0.1622	-0.1084	0.9808
49	-25.99971	38.91082	9.30865	-0.5449	0.8155	0.1951	342.14065	0.8315	0.5556	0.	0.1084	-0.1622	0.9808
50	-9.12972	45.89863	9.30865	-0.1913	0.9619	0.1951	342.14065	0.9808	0.1951	0.	0.0381	-0.1913	0.9808
51	-6.58224	6.58224	-46.79805	-0.1379	0.1379	-0.9808	272.22356	0.7071	0.7071	-0.	0.6935	-0.6935	-0.1951
52	-24.49098	10.14461	-39.67330	-0.5133	0.2126	-0.8315	387.60610	0.3827	0.9239	-0.	0.7682	-0.3182	-0.5556
53	-10.14461	24.49098	-39.67330	-0.2126	0.5133	-0.8315	387.60610	0.9239	0.3827	-0.	0.3182	-0.7682	-0.5556
54	-38.32154	10.26819	-26.50883	-0.8031	0.2152	-0.5556	386.74096	0.2588	0.9659	-0.	0.5366	-0.1438	-0.8315
55	-28.05335	28.05335	-26.50883	-0.5879	0.5879	-0.5556	386.74096	0.7071	0.7071	-0.	0.3928	-0.3928	-0.8315
56	-10.26819	38.32154	-26.50883	-0.2152	0.8031	-0.5556	386.74096	0.9659	0.2588	-0.	0.1438	-0.5366	-0.8315
57	-45.89863	9.12972	-9.30865	-0.9619	0.1913	-0.1951	342.14065	0.1951	0.9808	-0.	0.1913	-0.0381	-0.9808
58	-38.91082	25.99971	-9.30865	-0.8155	0.5449	-0.1951	342.14065	0.5556	0.8315	-0.	0.1622	-0.1084	-0.9808
59	-25.99971	38.91082	-9.30865	-0.5449	0.8155	-0.1951	342.14065	0.8315	0.5556	-0.	0.1084	-0.1622	-0.9808
60	-9.12972	45.89863	-9.30865	-0.1913	0.9619	-0.1951	342.14065	0.9808	0.1951	-0.	0.0381	-0.1913	-0.9808
61	-6.58224	-6.58224	46.79805	-0.1379	-0.1379	0.9808	272.22356	0.7071	-0.7071	0.	0.6935	0.6935	0.1951
62	-24.49098	-10.14461	39.67330	-0.5133	-0.2126	0.8315	387.60610	0.3827	-0.9239	0.	0.7682	0.3182	0.5556
63	-10.14461	-24.49098	39.67330	-0.2126	-0.5133	0.8315	387.60610	0.9239	-0.3827	0.	0.3182	0.7682	0.5556
64	-38.32154	-10.26819	26.50883	-0.8031	-0.2152	0.5556	386.74096	0.2588	-0.9659	0.	0.5366	0.1438	0.8315
65	-28.05335	-28.05335	26.50883	-0.5879	-0.5879	0.5556	386.74096	0.7071	-0.7071	0.	0.3928	0.3928	0.8315
66	-10.26819	-38.32154	26.50883	-0.2152	-0.8031	0.5556	386.74096	0.9659	-0.2588	0.	0.1438	0.5366	0.8315
67	-45.89863	-9.12972	9.30865	-0.9619	-0.1913	0.1951	342.14065	0.1951	-0.9808	0.	0.1913	0.0381	0.9808
68	-38.91082	-25.99971	9.30865	-0.8155	-0.5449	0.1951	342.14065	0.5556	-0.8315	0.	0.1622	0.1084	0.9808
69	-25.99971	-38.91082	9.30865	-0.5449	-0.8155	0.1951	342.14065	0.8315	-0.5556	0.	0.1084	0.1622	0.9808
70	-9.12972	-45.89863	9.30865	-0.1913	-0.9619	0.1951	342.14065	0.9808	-0.1951	0.	0.0381	0.1913	0.9808
71	-6.58224	-6.58224	-46.79805	-0.1379	-0.1379	-0.9808	272.22356	0.7071	-0.7071	-0.	0.6935	0.6935	-0.1951
72	-24.49098	-10.14461	-39.67330	-0.5133	-0.2126	-0.8315	387.60610	0.3827	-0.9239	-0.	0.7682	0.3182	-0.5556
73	-10.14461	-24.49098	-39.67330	-0.2126	-0.5133	-0.8315	387.60610	0.9239	-0.3827	-0.	0.3182	0.7682	-0.5556
74	-38.32154	-10.26819	-26.50883	-0.8031	-0.2152	-0.5556	386.74096	0.2588	-0.9659	-0.	0.5366	0.1438	-0.8315
75	-28.05335	-28.05335	-26.50883	-0.5879	-0.5879	-0.5556	386.74096	0.7071	-0.7071	-0.	0.3928	-0.3928	-0.8315
76	-10.26819	-38.32154	-26.50883	-0.2152	-0.8031	-0.5556	386.74096	0.9659	-0.2588	-0.	0.1438	0.5366	-0.8315
77	-45.89863	-9.12972	-9.30865	-0.9619	-0.1913	-0.1951	342.14065	0.1951	-0.9808	-0.	0.1913	0.0381	-0.9808
78	-38.91082	-25.99971	-9.30865	-0.8155	-0.5449	-0.1951	342.14065	0.5556	-0.8315	-0.	0.1622	0.1084	-0.9808
79	-25.99971	-38.91082	-9.30865	-0.5449	-0.8155	-0.1951	342.14065	0.8315	-0.5556	-0.	0.1084	0.1622	-0.9808
80	-9.12972	-45.89863	-9.30865	-0.1913	-0.9619	-0.1951	342.14065	0.9808	-0.1951	-0.	0.0381	0.1913	-0.9808

```

***** DATA CARD NO. 1  FR 0 1 -0 -0 2.90000E+00 0. 0. 0. 0. 0.
***** DATA CARD NO. 2  EX 1 1 1 0 9.00000E+01 0. 0. 0. 0. 0.
***** DATA CARD NO. 3  RP 0 19 1 1000 9.00000E+01 0. -1.00000E+01 0. 0. 0.

```

----- FREQUENCY -----

FREQUENCY= 2.9000E+00 MHZ
WAVELENGTH= 1.0338E+02 METERS

APPROXIMATE INTEGRATION EMPLOYED FOR SEGMENTS MORE THAN 1.000 WAVELENGTHS APART

- - - STRUCTURE IMPEDANCE LOADING - - -

THIS STRUCTURE IS NOT LOADED

- - - ANTENNA ENVIRONMENT - - -
FREE SPACE

- - - MATRIX TIMING - - -

FILL* 0.137 SEC., FACTOR* 0.173 SEC.

- - - EXCITATION - - -

PLANE WAVE THETA= 90.00 DEG, PHI* 0. DEG, ETA= 0. DEG, TYPE -LINEAR= AXIAL RATIO=-0.

- - - SURFACE PATCH CURRENTS - - -

DISTANCE IN WAVELENGTHS
CURRENT IN AMPS/METER

- - SURFACE COMPONENTS - -

- - - RECTANGULAR COMPONENTS - - -

PATCH CENTER			TANGENT VECTOR 1		TANGENT VECTOR 2		X		Y		Z	
X	Y	Z	MAG.	PHASE	MAG.	PHASE	REAL	IMAG.	REAL	IMAG.	REAL	IMAG.
1												
0.064	0.064	0.453	2.8794E-03	-156.32	3.1198E-03	-157.39	3.86E-03	1.65E-03	1.33E-04	1.42E-05	-5.62E-04	-2.34E-04
2												
0.237	0.098	0.384	1.4256E-03	-91.29	4.7156E-03	-94.79	3.15E-04	4.16E-03	9.57E-05	1.79E-04	-2.19E-04	-2.61E-03
3												
0.098	0.237	0.384	3.2575E-03	-142.94	2.3664E-03	-147.56	3.04E-03	2.22E-03	5.39E-04	2.24E-04	-1.11E-03	-7.05E-04
4												
0.371	0.099	0.256	6.0841E-04	-43.12	4.9604E-03	-45.55	-1.98E-03	2.01E-03	-7.05E-05	1.07E-04	2.89E-03	-2.94E-03
5												
0.271	0.271	0.256	1.7787E-03	-79.48	3.9145E-03	-84.57	-3.75E-04	2.77E-03	8.40E-05	2.94E-04	3.08E-04	-3.24E-03
6												
0.099	0.371	0.256	2.2829E-03	-142.59	2.2575E-03	-151.48	2.04E-03	1.49E-03	5.95E-04	2.19E-04	-1.65E-03	-8.96E-04
7												
0.444	0.088	0.090	1.4688E-04	-14.13	5.2457E-03	-16.94	-9.88E-04	3.00E-04	-5.13E-05	2.30E-05	4.92E-03	-1.50E-03
8												
0.376	0.251	0.090	4.6333E-04	-40.19	4.4776E-03	-43.42	-7.24E-04	6.65E-04	-5.82E-05	8.50E-05	3.19E-03	-3.02E-03
9												
0.251	0.376	0.090	7.4095E-04	-85.74	3.3811E-03	-94.45	-1.74E-05	9.80E-04	7.32E-05	1.36E-04	-2.57E-04	-3.31E-03
10												
0.088	0.444	0.090	8.0344E-04	-147.10	2.2400E-03	-157.22	7.40E-04	4.61E-04	2.64E-04	8.08E-05	-2.03E-03	-8.51E-04
11												
0.064	0.064	-0.453	2.8794E-03	23.68	3.1198E-03	22.61	-3.86E-03	-1.65E-03	-1.33E-04	-1.42E-05	-5.62E-04	-2.34E-04
12												
0.237	0.098	-0.384	1.4256E-03	88.72	4.7156E-03	85.21	-3.15E-04	-4.16E-03	-9.57E-05	-1.79E-04	-2.19E-04	-2.61E-03
13												
0.098	0.237	-0.384	3.2575E-03	37.06	2.3664E-03	32.44	-3.04E-03	-2.22E-03	-5.39E-04	-2.24E-04	-1.11E-03	-7.05E-04
14												
0.371	0.099	-0.256	6.0841E-04	136.88	4.9604E-03	134.45	1.98E-03	-2.01E-03	7.05E-05	-1.07E-04	2.89E-03	-2.94E-03
15												
0.271	0.271	-0.256	1.7787E-03	100.52	3.9145E-03	95.43	3.75E-04	-2.77E-03	-8.40E-05	-2.94E-04	3.08E-04	-3.24E-03
16												
0.099	0.371	-0.256	2.2829E-03	37.41	2.2575E-03	28.52	-2.04E-03	-1.49E-03	-5.95E-04	-2.19E-04	-1.65E-03	-8.96E-04
17												
0.444	0.088	-0.090	1.4688E-04	165.87	5.2457E-03	163.06	9.88E-04	-3.00E-04	5.13E-05	-2.30E-05	4.92E-03	-1.50E-03
18												
0.376	0.251	-0.090	4.6333E-04	139.81	4.4776E-03	136.58	7.24E-04	-6.65E-04	5.82E-05	-8.50E-05	3.19E-03	-3.02E-03
19												
0.251	0.376	-0.090	7.4095E-04	94.27	3.3811E-03	85.55	1.74E-05	-9.80E-04	-7.32E-05	-1.36E-04	-2.57E-04	-3.31E-03
20												
0.088	0.444	-0.090	8.0344E-04	32.90	2.2400E-03	22.78	-7.40E-04	-4.61E-04	-2.64E-04	-8.08E-05	-2.03E-03	-8.51E-04
21												
0.064	-0.064	0.453	2.8794E-03	-156.32	3.1198E-03	-157.39	3.86E-03	1.65E-03	-1.33E-04	-1.42E-05	-5.62E-04	-2.34E-04
22												
0.237	-0.098	0.384	1.4256E-03	-91.29	4.7156E-03	-94.79	3.15E-04	4.16E-03	-9.57E-05	-1.79E-04	-2.19E-04	-2.61E-03
23												
0.098	-0.237	0.384	3.2575E-03	-142.94	2.3664E-03	-147.56	3.04E-03	2.22E-03	-5.39E-04	-2.24E-04	-1.11E-03	-7.05E-04

24	0.371	-0.099	0.256	6.0841E-04	-43.12	4.9604E-03	-45.55	-1.98E-03	2.01E-03	7.05E-05	-1.07E-04	2.89E-03	-2.94E-03
25	0.271	-0.271	0.256	1.7787E-03	-79.48	3.9145E-03	-84.57	-3.75E-04	2.77E-03	-8.40E-05	-2.94E-04	3.08E-04	-3.24E-03
26	0.099	-0.371	0.256	2.2829E-03	-142.59	2.2575E-03	-151.48	2.04E-03	1.49E-03	-5.95E-04	-2.19E-04	-1.65E-03	-8.96E-04
27	0.444	-0.088	0.090	1.4688E-04	-14.13	5.2457E-03	-16.94	-9.88E-04	3.00E-04	5.13E-05	-2.30E-05	4.92E-03	-1.50E-03
28	0.376	-0.251	0.090	4.6333E-04	-40.19	4.4776E-03	-43.42	-7.24E-04	6.65E-04	5.82E-05	-8.50E-05	3.19E-03	-3.02E-03
29	0.251	-0.376	0.090	7.4095E-04	-85.74	3.3811E-03	-94.45	-1.74E-05	9.80E-04	-7.32E-05	-1.36E-04	-2.57E-04	-3.31E-03
30	0.088	-0.444	0.090	8.0344E-04	-147.10	2.2400E-03	-157.22	7.40E-04	4.61E-04	-2.64E-04	-8.08E-05	-2.03E-03	-8.51E-04
31	0.064	-0.064	-0.453	2.8794E-03	23.68	3.1198E-03	22.61	-3.86E-03	-1.65E-03	1.33E-04	1.42E-05	-5.62E-04	-2.34E-04
32	0.237	-0.098	-0.384	1.4256E-03	88.72	4.7156E-03	85.21	-3.15E-04	-4.16E-03	9.57E-05	1.79E-04	-2.19E-04	-2.61E-03
33	0.098	-0.237	-0.384	3.2575E-03	37.06	2.3664E-03	32.44	-3.04E-03	-2.22E-03	5.39E-04	2.24E-04	-1.11E-03	-7.05E-04
34	0.371	-0.099	-0.256	6.0841E-04	136.88	4.9604E-03	134.45	1.98E-03	-2.01E-03	-7.05E-05	1.07E-04	2.89E-03	-2.94E-03
35	0.271	-0.271	-0.256	1.7787E-03	100.52	3.9145E-03	95.43	3.75E-04	-2.77E-03	8.40E-05	2.94E-04	3.08E-04	-3.24E-03
36	0.099	-0.371	-0.256	2.2829E-03	37.41	2.2575E-03	28.52	-2.04E-03	-1.49E-03	5.95E-04	2.19E-04	-1.65E-03	-8.96E-04
37	0.444	-0.088	-0.090	1.4688E-04	165.87	5.2457E-03	163.06	9.88E-04	-3.00E-04	-5.13E-05	2.30E-05	4.92E-03	-1.50E-03
38	0.376	-0.251	-0.090	4.6333E-04	139.81	4.4776E-03	136.58	7.24E-04	-6.65E-04	-5.82E-05	8.50E-05	3.19E-03	-3.02E-03
39	0.251	-0.376	-0.090	7.4095E-04	94.27	3.3811E-03	85.55	1.74E-05	-9.80E-04	7.32E-05	1.36E-04	-2.57E-04	-3.31E-03
40	0.088	-0.444	-0.090	8.0344E-04	32.90	2.2400E-03	22.78	-7.40E-04	-4.61E-04	2.64E-04	8.08E-05	-2.03E-03	-8.51E-04
41	-0.064	0.064	0.453	2.9135E-03	-36.76	2.5234E-03	-37.39	3.04E-03	-2.30E-03	2.60E-04	-1.70E-04	3.91E-04	-2.99E-04
42	-0.237	0.098	0.384	1.9524E-03	-104.63	3.6573E-03	-105.40	-9.35E-04	-3.43E-03	-1.47E-04	-6.23E-04	-5.39E-04	-1.96E-03
43	-0.098	0.237	0.384	3.3932E-03	-51.87	6.3674E-04	-60.16	2.04E-03	-2.64E-03	5.58E-04	-5.97E-04	1.76E-04	-3.07E-04
44	-0.371	0.099	0.256	1.1507E-03	-138.16	1.8444E-03	-164.01	-1.17E-03	-4.71E-04	-5.73E-04	-6.68E-04	-1.47E-03	-4.23E-04
45	-0.271	0.271	0.256	2.6220E-03	-114.23	1.0836E-03	-121.84	-9.85E-04	-2.05E-03	-5.36E-04	-1.33E-03	-4.75E-04	-7.65E-04
46	-0.099	0.371	0.256	2.3855E-03	-52.80	4.0244E-04	137.80	1.35E-03	-1.80E-03	5.33E-04	-6.37E-04	-2.48E-04	2.25E-04
47	-0.444	0.088	0.090	3.3208E-04	-151.23	2.5093E-03	82.36	7.06E-06	4.45E-04	-2.98E-04	-2.51E-04	3.27E-04	2.44E-03
48	-0.376	0.251	0.090	8.6498E-04	-139.37	1.2097E-03	94.55	-3.80E-04	-1.17E-04	-5.35E-04	-5.99E-04	-9.42E-05	1.18E-03
49	-0.251	0.376	0.090	1.0285E-03	-108.70	3.1884E-04	82.46	-2.70E-04	-7.76E-04	-1.90E-04	-5.93E-04	4.10E-05	3.10E-04
50	-0.088	0.444	0.090	8.2755E-04	-48.33	9.1957E-04	137.33	5.14E-04	-5.83E-04	2.37E-04	-2.40E-04	-6.63E-04	6.11E-04
51	-0.064	0.064	-0.453	2.9135E-03	143.24	2.5234E-03	142.61	-3.04E-03	2.30E-03	-2.60E-04	1.70E-04	3.91E-04	-2.99E-04
52	-0.237	0.098	-0.384	1.9524E-03	75.37	3.6573E-03	74.61	9.35E-04	3.43E-03	1.47E-04	6.23E-04	-5.39E-04	-1.96E-03
53	-0.098	0.237	-0.384	3.3932E-03	128.13	6.3674E-04	119.84	-2.04E-03	2.64E-03	-5.58E-04	5.97E-04	1.76E-04	-3.07E-04
54	-0.371	0.099	-0.256	1.1507E-03	41.84	1.8444E-03	15.99	1.17E-03	4.71E-04	5.73E-04	6.68E-04	-1.47E-03	-4.23E-04
55	-0.271	0.271	-0.256	2.6220E-03	65.77	1.0836E-03	58.16	9.85E-04	2.05E-03	5.36E-04	1.33E-03	-4.75E-04	-7.65E-04
56	-0.099	0.371	-0.256	2.3855E-03	127.20	4.0244E-04	-42.20	-1.35E-03	1.80E-03	-5.33E-04	6.37E-04	-2.48E-04	2.25E-04
57	-0.444	0.088	-0.090	3.3208E-04	28.77	2.5093E-03	-97.64	-7.06E-06	-4.45E-04	2.98E-04	2.51E-04	3.27E-04	2.44E-03
58	-0.376	0.251	-0.090	8.6498E-04	40.63	1.2097E-03	-85.45	3.80E-04	1.17E-04	5.35E-04	5.99E-04	-9.42E-05	1.18E-03
59	-0.251	0.376	-0.090	1.0285E-03	71.30	3.1884E-04	-97.54	2.70E-04	7.76E-04	1.90E-04	5.93E-04	4.10E-05	3.10E-04
60	-0.088	0.444	-0.090	8.2755E-04	131.67	9.1957E-04	-42.67	-5.14E-04	5.83E-04	-2.37E-04	2.40E-04	-6.63E-04	6.11E-04
61	-0.064	-0.064	0.453	2.9135E-03	-36.76	2.5234E-03	-37.39	3.04E-03	-2.30E-03	-2.60E-04	1.70E-04	3.91E-04	-2.99E-04
62	-0.237	-0.098	0.384	1.9524E-03	-104.63	3.6573E-03	-105.40	-9.35E-04	-3.43E-03	1.47E-04	6.23E-04	-5.39E-04	-1.96E-03
63	-0.098	-0.237	0.384	3.3932E-03	-51.87	6.3674E-04	-60.16	2.04E-03	-2.64E-03	-5.58E-04	5.97E-04	1.76E-04	-3.07E-04

64	-0.371	-0.099	0.256	1.1507E-03	-138.16	1.8444E-03	-164.01	-1.17E-03	-4.71E-04	5.73E-04	6.68E-04	-1.47E-03	-4.23E-04
65	-0.271	-0.271	0.256	2.6220E-03	-114.23	1.0836E-03	-121.84	-9.85E-04	-2.05E-03	5.36E-04	1.33E-03	-4.75E-04	-7.65E-04
66	-0.099	-0.371	0.256	2.3855E-03	-52.80	4.0244E-04	137.80	1.35E-03	-1.80E-03	-5.33E-04	6.37E-04	-2.48E-04	2.25E-04
67	-0.444	-0.088	0.090	3.3208E-04	-151.23	2.5093E-03	82.36	7.06E-06	4.45E-04	2.98E-04	2.51E-04	3.27E-04	2.44E-03
68	-0.376	-0.251	0.090	8.6498E-04	-139.37	1.2097E-03	94.55	-3.80E-04	-1.17E-04	5.35E-04	5.99E-04	-9.42E-05	1.18E-03
69	-0.251	-0.376	0.090	1.0285E-03	-108.70	3.1884E-04	82.46	-2.70E-04	-7.76E-04	1.90E-04	5.93E-04	4.10E-05	3.10E-04
70	-0.088	-0.444	0.090	8.2755E-04	-48.33	9.1957E-04	137.33	5.14E-04	-5.83E-04	-2.37E-04	2.40E-04	-6.63E-04	6.11E-04
71	-0.064	-0.064	-0.453	2.9135E-03	143.24	2.5234E-03	142.61	-3.04E-03	2.30E-03	2.60E-04	-1.70E-04	3.91E-04	-2.99E-04
72	-0.237	-0.098	-0.384	1.9524E-03	75.37	3.6573E-03	74.61	9.35E-04	3.43E-03	-1.47E-04	-6.23E-04	-5.39E-04	-1.96E-03
73	-0.098	-0.237	-0.384	3.3932E-03	128.13	6.3674E-04	119.84	-2.04E-03	2.64E-03	5.58E-04	-5.97E-04	1.76E-04	-3.07E-04
74	-0.371	-0.099	-0.256	1.1507E-03	41.84	1.8444E-03	15.99	1.17E-03	4.71E-04	-5.73E-04	-6.68E-04	-1.47E-03	-4.23E-04
75	-0.271	-0.271	-0.256	2.6220E-03	65.77	1.0836E-03	56.16	9.85E-04	2.05E-03	-5.36E-04	-1.33E-03	-4.75E-04	-7.65E-04
76	-0.099	-0.371	-0.256	2.3855E-03	127.20	4.0244E-04	-42.20	-1.35E-03	1.80E-03	5.33E-04	-6.37E-04	-2.48E-04	2.25E-04
77	-0.444	-0.088	-0.090	3.3208E-04	28.77	2.5093E-03	-97.64	-7.06E-06	-4.45E-04	-2.98E-04	-2.51E-04	3.27E-04	2.44E-03
78	-0.376	-0.251	-0.090	8.6498E-04	40.63	1.2097E-03	-85.45	3.80E-04	1.17E-04	-5.35E-04	-5.99E-04	-9.42E-05	1.18E-03
79	-0.251	-0.376	-0.090	1.0285E-03	71.30	3.1884E-04	-97.54	2.70E-04	7.76E-04	-1.90E-04	-5.93E-04	4.10E-05	3.10E-04
80	-0.088	-0.444	-0.090	8.2755E-04	131.67	9.1957E-04	-42.67	-5.14E-04	5.83E-04	2.37E-04	-2.40E-04	-6.63E-04	6.11E-04

--- RADIATION PATTERNS ---

-- ANGLES --		- POWER GAINS -			- - - POLARIZATION - - -			- - - E(THETA) - - -		- - - E(PHI) - - -	
THETA	PHI	VERT.	HOR.	TOTAL	AXIAL	TILT	SENSE	MAGNITUDE	PHASE	MAGNITUDE	PHASE
DEGREES	DEGREES	DB	DB	DB	RATIO	DEG.		VOLTS/M	DEGREES	VOLTS/M	DEGREES
90.00	0.	-4.44	-999.99	-4.44	0.00000	-0.00	LINEAR	1.74852E+01	163.80	2.18710E-14	-70.25
80.00	0.	-4.04	-999.99	-4.04	0.00000	0.00	LINEAR	1.83237E+01	161.67	5.30030E-14	-134.19
70.00	0.	-2.96	-999.99	-2.96	0.00000	0.00	LINEAR	2.07470E+01	156.86	3.63582E-14	-129.70
60.00	0.	-1.61	-999.99	-1.61	0.00000	0.00	LINEAR	2.42168E+01	152.14	7.79242E-14	-144.37
50.00	0.	-0.50	-999.99	-0.50	0.00000	0.00	LINEAR	2.75240E+01	148.81	9.46562E-14	-153.15
40.00	0.	-0.03	-999.99	-0.03	0.00000	0.00	LINEAR	2.90492E+01	146.61	7.09105E-14	169.28
30.00	0.	-0.59	-999.99	-0.59	0.00000	0.00	LINEAR	2.72599E+01	144.38	1.01132E-13	126.51
20.00	0.	-2.73	-999.99	-2.73	0.00000	0.00	LINEAR	2.13035E+01	139.32	1.55612E-13	143.83
10.00	0.	-7.57	-999.99	-7.57	0.00000	0.00	LINEAR	1.22053E+01	118.96	2.34637E-13	116.16
0.	0.	-8.64	-999.99	-8.64	0.00000	0.00	LINEAR	1.07892E+01	44.17	3.62102E-13	126.29
-10.00	0.	-1.91	-999.99	-1.91	0.00000	-0.00	LINEAR	2.34179E+01	14.76	3.96954E-13	138.13
-20.00	0.	1.94	-999.99	1.94	0.00000	-0.00	LINEAR	3.64467E+01	11.84	5.05636E-13	141.53
-30.00	0.	3.84	-999.99	3.84	0.00000	-0.00	LINEAR	4.53564E+01	16.56	5.87664E-13	145.54
-40.00	0.	4.51	-999.99	4.51	0.00000	-0.00	LINEAR	4.89894E+01	27.10	5.63541E-13	143.84
-50.00	0.	4.63	-999.99	4.63	0.00000	-0.00	LINEAR	4.96673E+01	44.19	5.92554E-13	162.05
-60.00	0.	5.12	-999.99	5.12	0.00000	-0.00	LINEAR	5.25643E+01	65.77	4.54763E-13	166.85
-70.00	0.	6.29	-999.99	6.29	0.00000	0.00	LINEAR	6.01727E+01	84.51	3.70544E-13	159.84
-80.00	0.	7.42	-999.99	7.42	0.00000	0.00	LINEAR	6.85141E+01	95.53	1.02413E-13	165.68
-90.00	0.	7.86	-999.99	7.86	0.00000	-0.00	LINEAR	7.20510E+01	99.00	2.78146E-14	-56.61

***** DATA CARD NO. 4 RP 0 1 19 1000 9.00000E+01 0. 0. 1.00000E+01 0. 0.

--- RADIATION PATTERNS ---

-- ANGLES --		- POWER GAINS -			- - - POLARIZATION - - -			- - - E(THETA) - - -		- - - E(PHI) - - -	
THETA	PHI	VERT.	HOR.	TOTAL	AXIAL	TILT	SENSE	MAGNITUDE	PHASE	MAGNITUDE	PHASE
DEGREES	DEGREES	DB	DB	DB	RATIO	DEG.		VOLTS/M	DEGREES	VOLTS/M	DEGREES
90.00	0.	-4.44	-999.99	-4.44	0.00000	-0.00	LINEAR	1.74852E+01	163.80	2.18710E-14	-70.25
90.00	10.00	-4.28	-999.99	-4.28	0.00000	0.00	LINEAR	1.78240E+01	161.73	1.13587E-11	144.10
90.00	20.00	-3.79	-999.99	-3.79	0.00000	0.00	LINEAR	1.88459E+01	156.08	2.59805E-11	139.09
90.00	30.00	-3.06	-999.99	-3.06	0.00000	0.00	LINEAR	2.04929E+01	148.15	4.67714E-11	133.96
90.00	40.00	-2.25	-999.99	-2.25	0.00000	0.00	LINEAR	2.25127E+01	139.17	7.44719E-11	129.35
90.00	50.00	-1.54	-999.99	-1.54	0.00000	0.00	LINEAR	2.44300E+01	129.63	1.05444E-10	124.77
90.00	60.00	-1.11	-999.99	-1.11	0.00000	0.00	LINEAR	2.56764E+01	119.17	1.32426E-10	118.12
90.00	70.00	-1.05	-999.99	-1.05	0.00000	0.00	LINEAR	2.58334E+01	106.70	1.47995E-10	106.17

90.00	80.00	-1.34	-999.99	-1.34	0.00000	0.00	LINEAR	2.49858E+01	90.48	1.58246E-10	83.46
90.00	90.00	-1.67	-999.99	-1.67	0.00000	0.00	LINEAR	2.40598E+01	68.79	2.02901E-10	51.14
90.00	100.00	-1.45	-999.99	-1.45	0.00000	0.00	LINEAR	2.46845E+01	42.25	3.22798E-10	26.41
90.00	110.00	-0.38	-999.99	-0.38	0.00000	0.00	LINEAR	2.79070E+01	15.31	5.04645E-10	13.26
90.00	120.00	1.14	-999.99	1.14	0.00000	0.00	LINEAR	3.32413E+01	-8.45	7.07611E-10	6.43
90.00	130.00	2.70	-999.99	2.70	0.00000	0.00	LINEAR	3.97937E+01	-28.99	8.79638E-10	2.69
90.00	140.00	4.20	-999.99	4.20	0.00000	0.00	LINEAR	4.72787E+01	-46.85	9.65335E-10	0.52
90.00	150.00	5.60	-999.99	5.60	0.00000	0.00	LINEAR	5.55509E+01	-61.58	9.20403E-10	-0.77
90.00	160.00	6.78	-999.99	6.78	0.00000	0.00	LINEAR	6.36601E+01	-72.39	7.26147E-10	-1.50
90.00	170.00	7.58	-999.99	7.58	0.00000	0.00	LINEAR	6.97660E+01	-78.86	4.01220E-10	-1.89
90.00	180.00	7.86	-999.99	7.86	0.00000	-0.00	LINEAR	7.20510E+01	-81.00	2.89339E-10	165.20

***** DATA CARD NO. 5 NE 0 1 1 1 0. 0. 0. 0. 0. 5.00000E+00

- - - NEAR ELECTRIC FIELDS - - -

- LOCATION -			- EX -		- EY -		- EZ -	
X	Y	Z	MAGNITUDE	PHASE	MAGNITUDE	PHASE	MAGNITUDE	PHASE
METERS	METERS	METERS	VOLTS/M	DEGREES	VOLTS/M	DEGREES	VOLTS/M	DEGREES
0.	0.	0.	5.3925E-12	-0.90	1.0166E-15	-137.49	9.9619E-01	0.03
0.	0.	5.0000	2.4040E-02	79.71	8.4836E-16	105.17	9.9612E-01	0.04
0.	0.	10.0000	4.6950E-02	79.76	2.4001E-15	151.51	9.9585E-01	0.04
0.	0.	15.0000	6.7922E-02	79.86	6.0384E-15	141.81	9.9523E-01	0.06
0.	0.	20.0000	8.7167E-02	80.01	1.0594E-14	145.35	9.9357E-01	0.10
0.	0.	25.0000	1.0747E-01	80.30	1.1298E-14	155.70	9.8943E-01	0.20
0.	0.	30.0000	1.3472E-01	80.92	1.7137E-14	145.69	9.8671E-01	0.29
0.	0.	35.0000	1.5167E-01	81.47	3.0835E-14	155.51	1.0307E+00	-0.45
0.	0.	40.0000	1.0076E-01	-87.91	6.8201E-14	175.61	1.2282E+00	-3.24
0.	0.	45.0000	1.2887E+00	-93.80	1.3565E-13	155.41	9.2209E-01	1.86
0.	0.	50.0000	1.2772E+00	-95.81	1.0507E-13	158.78	7.4353E-01	137.47

***** DATA CARD NO. 6 NE 0 1 1 1 0. 0. 0. 0. 5.00000E+00 0.

- - - NEAR ELECTRIC FIELDS - - -

- LOCATION -			- EX -		- EY -		- EZ -	
X	Y	Z	MAGNITUDE	PHASE	MAGNITUDE	PHASE	MAGNITUDE	PHASE
METERS	METERS	METERS	VOLTS/M	DEGREES	VOLTS/M	DEGREES	VOLTS/M	DEGREES
0.	0.	0.	5.3925E-12	-0.90	1.0166E-15	-137.49	9.9619E-01	0.03
0.	5.0000	0.	5.4000E-12	-0.92	2.0347E-15	-131.68	9.9611E-01	0.03
0.	10.0000	0.	5.4070E-12	-0.90	5.3031E-15	-130.86	9.9588E-01	0.02
0.	15.0000	0.	5.4116E-12	-0.93	8.1880E-15	-117.02	9.9556E-01	0.00
0.	20.0000	0.	5.4198E-12	-0.92	1.3949E-14	-107.28	9.9530E-01	-0.02
0.	25.0000	0.	5.4196E-12	-0.84	2.4479E-14	-107.58	9.9550E-01	-0.05
0.	30.0000	0.	5.4069E-12	-0.34	4.3827E-14	-106.82	9.9795E-01	0.05
0.	35.0000	0.	5.3724E-12	2.37	8.0732E-14	-98.87	1.0106E+00	1.19
0.	40.0000	0.	5.3836E-12	11.67	1.1552E-13	-93.37	1.0547E+00	6.03
0.	45.0000	0.	5.5517E-12	24.16	4.8489E-14	-81.24	1.1040E+00	12.69
0.	50.0000	0.	4.9511E-12	20.52	8.6013E-14	77.17	9.8244E-01	9.30

***** DATA CARD NO. 7 NE 0 1 1 1 0. 0. 0. 5.00000E+00 0. 0.

- - - NEAR ELECTRIC FIELDS - - -

- LOCATION -			- EX -		- EY -		- EZ -	
X	Y	Z	MAGNITUDE	PHASE	MAGNITUDE	PHASE	MAGNITUDE	PHASE
METERS	METERS	METERS	VOLTS/M	DEGREES	VOLTS/M	DEGREES	VOLTS/M	DEGREES
0.	0.	0.	5.3925E-12	-0.90	1.0166E-15	-137.49	9.9619E-01	0.03
5.0000	0.	0.	5.3414E-12	15.62	5.5943E-17	-7.13	9.8692E-01	16.52
10.0000	0.	0.	5.2698E-12	32.42	6.2145E-16	83.59	9.6987E-01	33.41
15.0000	0.	0.	5.1782E-12	49.72	2.5019E-16	-146.31	9.4938E-01	50.89
20.0000	0.	0.	5.1012E-12	67.31	2.5209E-15	150.12	9.3104E-01	69.02
25.0000	0.	0.	5.0456E-12	85.35	6.5671E-16	-105.95	9.1939E-01	87.56
30.0000	0.	0.	5.0609E-12	103.90	1.1530E-15	141.48	9.0782E-01	106.78
35.0000	0.	0.	5.2775E-12	122.98	1.6290E-15	-67.31	8.5662E-01	130.00
40.0000	0.	0.	5.2445E-12	139.21	7.6925E-16	21.71	8.5966E-01	174.27
45.0000	0.	0.	2.2474E-12	160.16	2.7984E-15	74.17	1.3188E+00	-148.03
50.0000	0.	0.	3.1133E-12	-59.09	2.1228E-15	40.83	1.2074E+00	-148.66

***** DATA CARD NO. 8 NH 0 1 1 11 0. 0. 0. 0. 0. 5.0000E+00

- - - NEAR MAGNETIC FIELDS - - -

- LOCATION -			- HX -		- HY -		- HZ -	
X	Y	Z	MAGNITUDE	PHASE	MAGNITUDE	PHASE	MAGNITUDE	PHASE
METERS	METERS	METERS	AMPS/M	DEGREES	AMPS/M	DEGREES	AMPS/M	DEGREES
0.	0.	0.	5.9821E-17	-48.31	2.2789E-03	1.96	2.4131E-18	-115.12
0.	0.	5.0000	6.1563E-17	-44.64	2.2876E-03	1.91	8.2636E-18	-85.25
0.	0.	10.0000	5.7535E-17	-41.41	2.3137E-03	1.77	1.9394E-17	-68.67
0.	0.	15.0000	7.8059E-17	-28.95	2.3568E-03	1.55	2.4643E-17	-91.73
0.	0.	20.0000	6.9512E-17	-25.85	2.4177E-03	1.26	3.0859E-17	-71.19
0.	0.	25.0000	6.4944E-17	-16.61	2.5014E-03	0.91	5.5485E-17	-43.29
0.	0.	30.0000	5.9037E-17	-16.16	2.6239E-03	0.48	6.4616E-17	-50.03
0.	0.	35.0000	5.6807E-17	-3.45	2.8061E-03	-0.04	8.3501E-17	-48.00
0.	0.	40.0000	6.3604E-17	2.69	2.9018E-03	-0.28	1.5220E-16	-15.68
0.	0.	45.0000	5.1412E-17	4.84	1.9299E-03	2.40	1.7884E-16	-11.27
0.	0.	50.0000	3.5975E-17	22.97	3.5955E-04	125.57	1.7377E-16	-15.01

***** DATA CARD NO. 9 NH 0 1 11 1 0. 0. 0. 0. 5.0000E+00 0.

- - - NEAR MAGNETIC FIELDS - - -

- LOCATION -			- HX -		- HY -		- HZ -	
X	Y	Z	MAGNITUDE	PHASE	MAGNITUDE	PHASE	MAGNITUDE	PHASE
METERS	METERS	METERS	AMPS/M	DEGREES	AMPS/M	DEGREES	AMPS/M	DEGREES
0.	0.	0.	5.9821E-17	-48.31	2.2789E-03	1.96	2.4131E-18	-115.12
0.	5.0000	0.	2.4437E-06	-33.79	2.2814E-03	1.94	1.2709E-16	-104.26
0.	10.0000	0.	4.6773E-06	-31.84	2.2888E-03	1.89	2.4324E-16	-102.28
0.	15.0000	0.	6.5547E-06	-28.51	2.3015E-03	1.81	3.1727E-16	-100.58
0.	20.0000	0.	8.0915E-06	-24.05	2.3196E-03	1.71	3.5005E-16	-100.21
0.	25.0000	0.	9.8609E-06	-20.06	2.3435E-03	1.58	3.4454E-16	-101.76
0.	30.0000	0.	1.5590E-05	-18.85	2.3757E-03	1.46	2.8513E-16	-102.54
0.	35.0000	0.	4.6067E-05	-15.18	2.4241E-03	1.45	2.2627E-16	-138.35
0.	40.0000	0.	1.8253E-04	-9.27	2.4817E-03	1.51	8.2107E-16	172.81
0.	45.0000	0.	5.5127E-04	-7.05	2.4295E-03	0.45	2.7849E-15	169.33
0.	50.0000	0.	1.0005E-03	-9.09	2.1016E-03	-4.19	5.2122E-15	167.19

***** DATA CARD NO. 10 NH 0 11 1 1 0. 0. 0. 5.0000E+00 0. 0.

- - - NEAR MAGNETIC FIELDS - - -

- LOCATION -			- HX -		- HY -		- HZ -	
X	Y	Z	MAGNITUDE	PHASE	MAGNITUDE	PHASE	MAGNITUDE	PHASE
METERS	METERS	METERS	AMPS/M	DEGREES	AMPS/M	DEGREES	AMPS/M	DEGREES
0.	0.	0.	5.9821E-17	-48.31	2.2789E-03	1.96	2.4131E-18	-115.12
5.0000	0.	0.	4.7469E-17	-36.27	2.3306E-03	21.82	1.9067E-18	146.08
10.0000	0.	0.	4.3046E-17	-9.13	2.4170E-03	40.81	3.1094E-18	-152.77
15.0000	0.	0.	4.8357E-17	15.88	2.5179E-03	58.74	3.1518E-18	-178.65
20.0000	0.	0.	6.3761E-17	34.78	2.6126E-03	75.71	3.1917E-18	164.11
25.0000	0.	0.	6.4841E-17	57.99	2.6847E-03	91.98	1.7174E-18	-73.50
30.0000	0.	0.	7.6920E-17	89.52	2.7211E-03	107.70	1.3053E-18	-119.89
35.0000	0.	0.	1.1043E-16	102.88	2.6696E-03	122.20	6.4783E-19	164.22
40.0000	0.	0.	1.3983E-16	125.67	2.2557E-03	132.88	4.7279E-19	27.30
45.0000	0.	0.	1.8744E-16	131.57	9.8588E-04	132.95	2.2486E-18	153.13
50.0000	0.	0.	1.4616E-16	130.28	6.7883E-04	-24.20	1.4668E-18	-141.75

***** DATA CARD NO. 11 EN -0 -0 -0 -0 0. 0. 0. 0. 0. 0.

RUN TIME = 1.155

EXAMPLE 10, MONOPOLE ON RADIAL WIRE GROUND SCREEN

Example 10 is a monopole antenna on a sparse radial wire ground screen using the Sommerfeld/Norton ground method. Part of the interpolation grid from SOMNEC is reproduced so that the user can check that his code is operating correctly.

The NGF has been used to take advantage of the symmetry of the ground screen before adding the monopole on the axis of rotation. The addition of the monopole results in 12 new unknowns. This includes the six segments in the monopole and segments at the junction of the six radial wires. The basis functions for these junction segments are modified and have become new unknowns. The currents represented by these new unknowns are printed in their normal locations in the table of currents.

The NGF can be tested on any of the other examples in this section by splitting the structure at some point. The results should be unchanged, although small differences may occur on computers with less than a 60-bit word length.

SOMNEC Input

4 .001 10. 1

SOMNEC Output

INEC GROUND INTERPOLATION GRID
DIELECTRIC CONSTANT= 4.00000E+00-1.79760E+00

GRID 1
R(1)= 0. DR= 0.0200 NR= 11
THET(1)= 0. DTH= 0.1745 NTH= 10

ERV

IR= 1
-2.74856E+01-9.85744E+01-2.30632E+01-8.27137E+01-1.92457E+01-6.90225E+01-1.58688E+01-5.69119E+01-1.28168E+01-4.59660E+01
-1.00040E+01-3.58781E+01-7.36475E+00-2.64129E+01-4.84646E+00-1.73813E+01-2.40468E+00-8.62414E+00 0. 0.
IR= 2
-1.86579E+01-1.03932E+02-1.59705E+01-8.72788E+01-1.35622E+01-7.28713E+01-1.13519E+01-6.01062E+01-9.28501E+00-4.85557E+01
-7.32126E+00-3.79036E+01-5.43193E+00-2.79051E+01-3.59409E+00-1.83636E+01-1.78914E+00-9.11143E+00-5.11809E-06-2.60360E-05
IR= 3
-1.41444E+01-1.10156E+02-1.26943E+01-9.23600E+01-1.11792E+01-7.69796E+01-9.62047E+00-6.33842E+01-8.03386E+00-5.11214E+01
-6.43293E+00-3.98504E+01-4.82576E+00-2.93055E+01-3.21650E+00-1.92693E+01-1.60795E+00-9.55601E+00-2.30303E-06-1.36509E-05
IR= 4
-1.23604E+01-1.16155E+02-1.16584E+01-9.69965E+01-1.05936E+01-8.05413E+01-9.29904E+00-6.60991E+01-7.86434E+00-5.31640E+01
-6.34750E+00-4.13512E+01-4.78515E+00-3.03581E+01-3.19886E+00-1.99381E+01-1.60162E+00-9.88088E+00-1.53005E-06-9.40784E-06
IR= 5
-1.25249E+01-1.21586E+02-1.20994E+01-1.00948E+02-1.10999E+01-8.34414E+01-9.76939E+00-6.81857E+01-8.25762E+00-5.46721E+01
-6.65317E+00-4.24246E+01-5.00534E+00-3.10933E+01-3.34404E+00-2.03976E+01-1.67063E+00-1.01020E+01-1.19653E-06-7.21220E-06
IR= 6
-1.41302E+01-1.26296E+02-1.35374E+01-1.04152E+02-1.22763E+01-8.56036E+01-1.06801E+01-6.98931E+01-8.93517E+00-5.57152E+01
-7.13833E+00-4.31426E+01-5.33589E+00-3.15738E+01-3.54492E+00-2.06934E+01-1.76822E+00-1.02432E+01-1.01226E-06-5.84944E-06
IR= 7
-1.68098E+01-1.30214E+02-1.56428E+01-1.06613E+02-1.38486E+01-8.71644E+01-1.18185E+01-7.06996E+01-9.73585E+00-5.63760E+01
-7.68809E+00-4.35806E+01-5.69822E+00-3.18597E+01-3.76407E+00-2.08671E+01-1.87135E+00-1.03255E+01-8.91793E-07-4.91316E-06
IR= 8
-2.02797E+01-1.33315E+02-1.81756E+01-1.08371E+02-1.56316E+01-8.81679E+01-1.30429E+01-7.12863E+01-1.05653E+01-5.67312E+01
-8.23855E+00-4.38031E+01-6.05153E+00-3.20004E+01-3.97364E+00-2.09514E+01-1.96882E+00-1.03653E+01-8.03299E-07-4.22729E-06
IR= 9
-2.43127E+01-1.35605E+02-2.09564E+01-1.09480E+02-1.74965E+01-8.86896E+01-1.42734E+01-7.15293E+01-1.13678E+01-5.68474E+01
-8.75517E+00-4.38632E+01-6.37519E+00-3.20349E+01-4.16215E+00-2.09716E+01-2.05552E+00-1.03750E+01-7.33085E-07-3.70232E-06
IR= 10
-2.87230E+01-1.37107E+02-2.38513E+01-1.10003E+02-1.93554E+01-8.88022E+01-1.54537E+01-7.14955E+01-1.21123E+01-5.67798E+01
-9.22080E+00-4.38032E+01-6.66008E+00-3.19928E+01-4.32515E+00-2.09467E+01-2.12965E+00-1.03638E+01-6.74464E-07-3.28752E-06
IR= 11
-3.33563E+01-1.37857E+02-2.67575E+01-1.10006E+02-2.11476E+01-8.85734E+01-1.65507E+01-7.12424E+01-1.27821E+01-5.65735E+01
-9.62801E+00-4.36557E+01-6.90369E+00-3.18967E+01-4.46185E+00-2.08907E+01-2.19118E+00-1.03383E+01-6.23956E-07-2.95174E-06

EZV

IR= 1
-2.74856E+01-9.85744E+01-2.74856E+01-9.85744E+01-2.74856E+01-9.85744E+01-2.74856E+01-9.85744E+01-2.74856E+01-9.85744E+01
-2.74856E+01-9.85744E+01-2.74856E+01-9.85744E+01-2.74856E+01-9.85744E+01-2.74856E+01-9.85744E+01-2.74856E+01-9.85744E+01
IR= 2
-4.57776E+01-8.96703E+01-4.46514E+01-8.90911E+01-4.36489E+01-8.86498E+01-4.27766E+01-8.83202E+01-4.20381E+01-8.80790E+01
-4.14347E+01-8.79077E+01-4.09666E+01-8.77903E+01-4.06331E+01-8.77149E+01-4.04335E+01-8.76730E+01-4.03671E+01-8.76596E+01
IR= 3
-6.27084E+01-7.96970E+01-5.91642E+01-7.84308E+01-5.61127E+01-7.76169E+01-5.35418E+01-7.71269E+01-5.14291E+01-7.68596E+01
-4.97483E+01-7.67349E+01-4.84731E+01-7.66935E+01-4.75804E+01-7.67022E+01-4.70519E+01-7.67027E+01-4.68771E+01-7.67079E+01
IR= 4
-7.82431E+01-6.88278E+01-7.15459E+01-6.71713E+01-6.59529E+01-6.63548E+01-6.13759E+01-6.60804E+01-5.77137E+01-6.61271E+01
-5.48674E+01-6.63353E+01-5.27492E+01-6.65929E+01-5.12659E+01-6.68339E+01-5.04326E+01-6.69805E+01-5.01509E+01-6.70355E+01
IR= 5
-3.23655E+01-5.72283E+01-8.20744E+01-5.56067E+01-7.37230E+01-5.52057E+01-6.70696E+01-5.55111E+01-6.18734E+01-5.61664E+01
-5.79187E+01-5.69318E+01-5.50258E+01-5.76498E+01-5.30525E+01-5.82293E+01-5.19135E+01-5.85840E+01-5.15388E+01-5.87084E+01
IR= 6
-1.05077E+02-4.50597E+01-9.09543E+01-4.39428E+01-7.98000E+01-4.43583E+01-7.11324E+01-4.55545E+01-6.45108E+01-4.70449E+01
-5.95653E+01-4.85241E+01-5.60032E+01-4.98055E+01-5.36065E+01-5.07795E+01-5.22263E+01-5.13840E+01-5.17757E+01-5.15886E+01
IR= 7
-1.16392E+02-3.24730E+01-9.83588E+01-3.23355E+01-8.44707E+01-3.39265E+01-7.39265E+01-3.62629E+01-6.60320E+01-3.87504E+01
-6.02354E+01-4.10431E+01-5.61173E+01-4.29459E+01-5.33754E+01-4.43542E+01-5.18076E+01-4.52150E+01-5.12975E+01-4.55041E+01

IR= 8
-1.26343E+02-1.96118E+01-1.04430E+02-2.09072E+01-8.79636E+01-2.39798E+01-7.57229E+01-2.76450E+01-6.67249E+01-3.12369E+01
-6.02185E+01-3.43983E+01-5.56529E+01-3.69477E+01-5.26417E+01-3.87998E+01-5.09304E+01-3.99192E+01-5.03754E+01-4.02933E+01
IR= 9
-1.34972E+02-6.60888E+00-1.09315E+02-9.75364E+00-9.04685E+01-1.45584E+01-7.67314E+01-1.96866E+01-6.68001E+01-2.44455E+01
-5.97175E+01-2.84979E+01-5.48026E+01-3.16960E+01-5.15877E+01-3.39866E+01-4.97710E+01-3.53591E+01-4.91834E+01-3.58159E+01
IR= 10
-1.42331E+02 6.41451E+00-1.13138E+02 1.04834E+00-9.21450E+01-5.68198E+00-7.71170E+01-1.23603E+01-6.64153E+01-1.83134E+01
-5.88775E+01-2.32547E+01-5.36984E+01-2.70882E+01-5.03360E+01-2.98030E+01-4.84454E+01-3.14182E+01-4.78355E+01-3.19539E+01
IR= 11
-1.48484E+02 1.93481E+01-1.16018E+02 1.14440E+01-9.31298E+01 2.64403E+00-7.70114E+01-5.63125E+00-6.56894E+01-1.27787E+01
-5.78030E+01-1.85901E+01-5.24325E+01-2.30353E+01-4.89693E+01-2.61544E+01-4.70310E+01-2.79993E+01-4.64072E+01-2.86093E+01

ERH

IR= 1
-2.39885E+01-1.21646E+02-2.45059E+01-1.18233E+02-2.48798E+01-1.15766E+02-2.51542E+01-1.13956E+02-2.53569E+01-1.12619E+02
-2.55054E+01-1.11639E+02-2.56115E+01-1.10939E+02-2.56827E+01-1.10469E+02-2.57237E+01-1.10199E+02-2.57371E+01-1.10110E+02
IR= 2
-3.33919E+01-1.14888E+02-3.35805E+01-1.11247E+02-3.35971E+01-1.08612E+02-3.35239E+01-1.06681E+02-3.34117E+01-1.05260E+02
-3.32905E+01-1.04225E+02-3.31812E+01-1.03491E+02-3.30959E+01-1.03000E+02-3.30423E+01-1.02719E+02-3.30241E+01-1.02628E+02
IR= 3
-4.17804E+01-1.07573E+02-4.08233E+01-1.03741E+02-3.98368E+01-1.01057E+02-3.89171E+01-9.91652E+01-3.81126E+01-9.78342E+01
-3.74469E+01-9.69059E+01-3.69287E+01-9.62742E+01-3.65590E+01-9.58787E+01-3.63395E+01-9.56394E+01-3.62662E+01-9.55662E+01
IR= 4
-4.91486E+01-9.98277E+01-4.66239E+01-9.60621E+01-4.43704E+01-9.36014E+01-4.24542E+01-9.20047E+01-4.08854E+01-9.09806E+01
-3.96490E+01-9.03347E+01-3.87210E+01-8.99379E+01-3.80739E+01-8.97171E+01-3.76999E+01-8.95854E+01-3.75753E+01-8.95483E+01
IR= 5
-5.55037E+01-9.17698E+01-5.11943E+01-8.83875E+01-4.75927E+01-8.64296E+01-4.46807E+01-8.53527E+01-4.23903E+01-8.48066E+01
-4.06419E+01-8.45668E+01-3.93617E+01-8.44900E+01-3.84844E+01-8.44970E+01-3.79843E+01-8.45036E+01-3.78185E+01-8.45122E+01
IR= 6
-6.08649E+01-8.35130E+01-5.46920E+01-8.08393E+01-4.97714E+01-7.96340E+01-4.59429E+01-7.92543E+01-4.30246E+01-7.93049E+01
-4.08527E+01-7.95462E+01-3.92937E+01-7.98347E+01-3.82477E+01-8.00864E+01-3.76467E+01-8.02532E+01-3.74506E+01-8.03113E+01
IR= 7
-6.52608E+01-7.51591E+01-5.72491E+01-7.35053E+01-5.11085E+01-7.32635E+01-4.64829E+01-7.37104E+01-4.30500E+01-7.44308E+01
-4.05494E+01-7.51911E+01-3.87842E+01-7.58622E+01-3.76148E+01-7.63747E+01-3.69482E+01-7.66932E+01-3.67316E+01-7.68009E+01
IR= 8
-6.87305E+01-6.68070E+01-5.89809E+01-6.64548E+01-5.17631E+01-6.73410E+01-4.64793E+01-6.86997E+01-4.26480E+01-7.01270E+01
-3.99087E+01-7.14167E+01-3.80027E+01-7.24684E+01-3.67536E+01-7.32361E+01-3.60464E+01-7.37012E+01-3.58175E+01-7.38567E+01
IR= 9
-7.13188E+01-5.85440E+01-5.99923E+01-5.97375E+01-5.18662E+01-6.18728E+01-4.60675E+01-6.41913E+01-4.19483E+01-6.63343E+01
-3.90505E+01-6.81448E+01-3.70595E+01-6.85631E+01-3.57664E+01-7.05731E+01-3.50387E+01-7.11759E+01-3.48039E+01-7.13762E+01
IR= 10
-7.30792E+01-5.04484E+01-6.03789E+01-5.33902E+01-5.15257E+01-5.68543E+01-4.53520E+01-6.01490E+01-4.10452E+01-6.29959E+01
-3.80579E+01-6.53059E+01-3.60273E+01-6.70695E+01-3.47188E+01-6.83048E+01-3.39863E+01-6.90351E+01-3.37505E+01-6.92763E+01
IR= 11
-7.40693E+01-4.25888E+01-6.02283E+01-4.74359E+01-5.08328E+01-5.22727E+01-4.44142E+01-5.65350E+01-4.00078E+01-6.00591E+01
-3.69882E+01-6.28394E+01-3.49548E+01-6.49226E+01-3.36530E+01-6.63650E+01-3.29278E+01-6.72113E+01-3.26946E+01-6.74899E+01
3.97417E+01 9.21195E+01 3.80476E+01 9.51882E+01 3.67047E+01 9.74106E+01 3.56341E+01 9.90529E+01 3.47856E+01 1.00277E+02
3.41268E+01 1.01185E+02 3.36340E+01 1.01841E+02 3.32920E+01 1.02286E+02 3.30906E+01 1.02543E+02 3.30241E+01 1.02628E+02
IR= 3
5.08754E+01 8.48512E+01 4.71987E+01 8.76423E+01 4.42543E+01 8.97820E+01 4.19043E+01 9.14610E+01 4.00516E+01 9.27867E+01
3.86227E+01 9.38197E+01 3.75635E+01 9.45963E+01 3.68331E+01 9.51509E+01 3.64088E+01 9.54600E+01 3.62662E+01 9.55662E+01
IR= 4
6.08619E+01 7.69197E+01 5.47880E+01 7.97338E+01 4.99932E+01 8.21080E+01 4.62345E+01 8.41186E+01 4.33254E+01 8.57969E+01
4.11215E+01 8.71574E+01 3.95129E+01 8.82078E+01 3.84148E+01 8.89655E+01 3.77835E+01 8.94000E+01 3.75753E+01 8.95483E+01
IR= 5
6.96927E+01 8.84670E+01 6.10132E+01 7.16720E+01 5.43068E+01 7.46058E+01 4.91640E+01 7.72097E+01 4.52663E+01 7.94395E+01
4.23685E+01 8.12704E+01 4.02861E+01 8.26928E+01 3.88812E+01 8.37156E+01 3.80814E+01 8.43108E+01 3.78185E+01 8.45122E+01
IR= 6
7.73745E+01 9.96316E+01 6.60254E+01 6.36095E+01 5.74608E+01 6.73967E+01 5.10409E+01 7.08033E+01 4.62743E+01 7.37247E+01
4.27933E+01 7.61152E+01 4.03286E+01 7.79631E+01 3.86906E+01 7.92722E+01 3.77549E+01 8.00523E+01 3.74506E+01 8.03113E+01
IR= 7
8.39264E+01 5.05403E+01 6.99535E+01 5.56612E+01 5.96600E+01 6.05539E+01 5.21125E+01 6.49190E+01 4.66171E+01 6.86211E+01
4.26690E+01 7.16177E+01 3.99104E+01 7.39123E+01 3.80953E+01 7.55266E+01 3.70654E+01 7.64839E+01 3.67316E+01 7.68009E+01
IR= 8
8.93816E+01 4.13159E+01 7.29148E+01 4.79204E+01 6.10690E+01 5.41202E+01 5.25642E+01 5.95502E+01 4.64818E+01 6.40807E+01
4.21764E+01 6.76988E+01 3.92033E+01 7.04406E+01 3.72646E+01 7.23543E+01 3.61709E+01 7.34836E+01 3.58175E+01 7.38567E+01
IR= 9
9.37814E+01 3.20695E+01 7.50180E+01 4.04582E+01 6.18261E+01 4.81179E+01 5.25390E+01 5.46766E+01 4.60046E+01 6.00515E+01
4.14400E+01 6.42846E+01 3.83206E+01 6.74591E+01 3.63020E+01 6.96586E+01 3.51690E+01 7.09504E+01 3.48039E+01 7.13762E+01
IR= 10
9.71786E+01 2.29022E+01 7.63647E+01 3.33302E+01 6.20474E+01 4.25555E+01 5.21490E+01 5.02704E+01 4.52856E+01 5.64810E+01
4.05467E+01 6.13077E+01 3.73370E+01 6.48922E+01 3.52740E+01 6.73591E+01 3.41212E+01 6.88019E+01 3.37505E+01 6.92763E+01
IR= 11
9.96324E+01 1.39035E+01 7.70502E+01 2.65747E+01 6.18331E+01 3.74303E+01 5.14831E+01 4.62997E+01 4.43997E+01 5.33201E+01
3.95576E+01 5.87091E+01 3.62035E+01 6.26757E+01 3.42239E+01 6.53999E+01 3.30663E+01 6.69709E+01 3.26946E+01 6.74899E+01

GRID 2

R(11)= 0.2000 DR= 0.0500 NR= 17
THET(11)= 0. DTH= 0.0873 NTH= 5

ERV

IR= 1
-3.33563E+01-1.37857E+02-2.99523E+01-1.22938E+02-2.67575E+01-1.10006E+02-2.38192E+01-9.86578E+01-2.11476E+01-8.85734E+01
IR= 2
-4.51212E+01-1.36765E+02-3.89508E+01-1.21282E+02-3.36137E+01-1.08161E+02-2.90321E+01-9.68368E+01-2.51062E+01-8.68907E+01
IR= 3
-5.60466E+01-1.32156E+02-4.68882E+01-1.17024E+02-3.93730E+01-1.04412E+02-3.32084E+01-9.36345E+01-2.81353E+01-8.42109E+01
IR= 4
-6.52517E+01-1.24999E+02-5.32439E+01-1.11070E+02-4.37619E+01-9.95510E+01-3.62386E+01-8.97147E+01-3.02258E+01-8.10761E+01
IR= 5
-7.23080E+01-1.16243E+02-5.78587E+01-1.04202E+02-4.67777E+01-9.41958E+01-3.82021E+01-8.55508E+01-3.14936E+01-7.78423E+01
IR= 6
-7.71127E+01-1.06729E+02-6.08009E+01-9.70430E+01-4.85630E+01-8.87911E+01-3.92621E+01-8.14547E+01-3.20975E+01-7.47264E+01

NEC Input

```
!
CMGREEN'S FUNCTION FOR RADIAL WIRE SCREEN OVER FINITE GROUND
CMSCREEN RADIUS = 30. M (1. WAVELENGTH RADIUS)
CESCREEN HEIGHT = .01 M 6 RADIAL WIRES
GH0.12.0..0..01.30..0..01..003.
GR0.6.
GE1.
FR0.1.0.0.10..
GN2.0.0.0.4..001.
WG
NX
CEMONOPOLE ON RADIAL WIRE GROUND SCREEN.
GF
GW1.6.0..0..01.0..0..7.51..003.
GE1.
EX0.1.1.0.1..
RP0.19.2.1001.0..0..5..90..
EN
```

NEC Output

 NUMERICAL ELECTROMAGNETICS CODE

- - - COMMENTS - - -

GREEN'S FUNCTION FOR RADIAL WIRE SCREEN OVER FINITE GROUND
 SCREEN RADIUS = 30. M 11. WAVELENGTH RADIUS
 SCREEN HEIGHT = .01 M 6 RADIAL WIRES

- - - STRUCTURE SPECIFICATION - - -

COORDINATES MUST BE INPUT IN
 METERS OR BE SCALED TO METERS
 BEFORE STRUCTURE INPUT IS ENDED

WIRE NO.	X1	Y1	Z1	X2	Y2	Z2	RADIUS	NO. OF SEG.	FIRST SEG.	LAST SEG.	TAG NO.
1	0.	0.	0.01000	30.00000	0.	0.01000	0.00300	12	1	12	0

STRUCTURE ROTATED ABOUT Z-AXIS 6 TIMES. LABELS INCREMENTED BY 0

GROUND PLANE SPECIFIED.

WHERE WIRE ENDS TOUCH GROUND, CURRENT WILL BE INTERPOLATED TO IMAGE IN GROUND PLANE.

TOTAL SEGMENTS USED= 72 NO. SEG. IN A SYMMETRIC CELL= 12 SYMMETRY FLAG= -1
 STRUCTURE HAS 6 FOLD ROTATIONAL SYMMETRY

- MULTIPLE WIRE JUNCTIONS -
 JUNCTION SEGMENTS (- FOR END 1, + FOR END 2)
 1 -1 -13 -25 -37 -49 -61

- - - SEGMENTATION DATA - - -

COORDINATES IN METERS

1+ AND 1- INDICATE THE SEGMENTS BEFORE AND AFTER 1

SEG. NO.	COORDINATES OF SEG. CENTER			SEG LENGTH	ORIENTATION ANGLES		WIRE RADIUS	CONNECTION DATA			TAG NO.
	X	Y	Z		ALPHA	BETA		1-	1	1+	
1	1.25000	0.	0.01000	2.50000	0.	0.	0.00300	-13	1	2	0
2	3.75000	0.	0.01000	2.50000	0.	0.	0.00300	1	2	3	0
3	6.25000	0.	0.01000	2.50000	0.	0.	0.00300	2	3	4	0
4	8.75000	0.	0.01000	2.50000	0.	0.	0.00300	3	4	5	0
5	11.25000	0.	0.01000	2.50000	0.	0.	0.00300	4	5	6	0
6	13.75000	0.	0.01000	2.50000	0.	0.	0.00300	5	6	7	0
7	16.25000	0.	0.01000	2.50000	0.	0.	0.00300	6	7	8	0
8	18.75000	0.	0.01000	2.50000	0.	0.	0.00300	7	8	9	0
9	21.25000	0.	0.01000	2.50000	0.	0.	0.00300	8	9	10	0
10	23.75000	0.	0.01000	2.50000	0.	0.	0.00300	9	10	11	0
11	26.25000	0.	0.01000	2.50000	0.	0.	0.00300	10	11	12	0
12	28.75000	0.	0.01000	2.50000	0.	0.	0.00300	11	12	0	0
13	0.62500	1.08253	0.01000	2.50000	0.	60.00000	0.00300	-25	13	14	0
14	1.87500	3.24760	0.01000	2.50000	0.	60.00000	0.00300	13	14	15	0
15	3.12500	5.41266	0.01000	2.50000	0.	60.00000	0.00300	14	15	16	0
16	4.37500	7.57772	0.01000	2.50000	0.	60.00000	0.00300	15	16	17	0
17	5.62500	9.74279	0.01000	2.50000	0.	60.00000	0.00300	16	17	18	0
18	6.87500	11.90785	0.01000	2.50000	0.	60.00000	0.00300	17	18	19	0
19	8.12500	14.07291	0.01000	2.50000	0.	60.00000	0.00300	18	19	20	0
20	9.37500	16.23798	0.01000	2.50000	0.	60.00000	0.00300	19	20	21	0
21	10.62500	18.40304	0.01000	2.50000	0.	60.00000	0.00300	20	21	22	0
22	11.87500	20.56810	0.01000	2.50000	0.	60.00000	0.00300	21	22	23	0
23	13.12500	22.73317	0.01000	2.50000	0.	60.00000	0.00300	22	23	24	0
24	14.37500	24.89823	0.01000	2.50000	0.	60.00000	0.00300	23	24	0	0

25	-0.62500	1.08253	0.01000	2.50000	0.	120.00000	0.00300	-37	25	26	0
26	-1.87500	3.24760	0.01000	2.50000	0.	120.00000	0.00300	25	26	27	0
27	-3.12500	5.41266	0.01000	2.50000	0.	120.00000	0.00300	26	27	28	0
28	-4.37500	7.57772	0.01000	2.50000	0.	120.00000	0.00300	27	28	29	0
29	-5.62500	9.74279	0.01000	2.50000	0.	120.00000	0.00300	28	29	30	0
30	-6.87500	11.90785	0.01000	2.50000	0.	120.00000	0.00300	29	30	31	0
31	-8.12500	14.07291	0.01000	2.50000	0.	120.00000	0.00300	30	31	32	0
32	-9.37500	16.23798	0.01000	2.50000	0.	120.00000	0.00300	31	32	33	0
33	-10.62500	18.40304	0.01000	2.50000	0.	120.00000	0.00300	32	33	34	0
34	-11.87500	20.56810	0.01000	2.50000	0.	120.00000	0.00300	33	34	35	0
35	-13.12500	22.73317	0.01000	2.50000	0.	120.00000	0.00300	34	35	36	0
36	-14.37500	24.89823	0.01000	2.50000	0.	120.00000	0.00300	35	36	0	0
37	-1.25000	-0.00000	0.01000	2.50000	0.	-180.00000	0.00300	-49	37	38	0
38	-3.75000	-0.00000	0.01000	2.50000	0.	-180.00000	0.00300	37	38	39	0
39	-6.25000	-0.00000	0.01000	2.50000	0.	-180.00000	0.00300	38	39	40	0
40	-8.75000	-0.00000	0.01000	2.50000	0.	-180.00000	0.00300	39	40	41	0
41	-11.25000	-0.00000	0.01000	2.50000	0.	-180.00000	0.00300	40	41	42	0
42	-13.75000	-0.00000	0.01000	2.50000	0.	-180.00000	0.00300	41	42	43	0
43	-16.25000	-0.00000	0.01000	2.50000	0.	-180.00000	0.00300	42	43	44	0
44	-18.75000	-0.00000	0.01000	2.50000	0.	-180.00000	0.00300	43	44	45	0
45	-21.25000	-0.00000	0.01000	2.50000	0.	-180.00000	0.00300	44	45	46	0
46	-23.75000	-0.00000	0.01000	2.50000	0.	-180.00000	0.00300	45	46	47	0
47	-26.25000	-0.00000	0.01000	2.50000	0.	-180.00000	0.00300	46	47	48	0
48	-28.75000	-0.00000	0.01000	2.50000	0.	-180.00000	0.00300	47	48	0	0
49	-0.62500	-1.08253	0.01000	2.50000	0.	-120.00000	0.00300	-61	49	50	0
50	-1.87500	-3.24760	0.01000	2.50000	0.	-120.00000	0.00300	49	50	51	0
51	-3.12500	-5.41266	0.01000	2.50000	0.	-120.00000	0.00300	50	51	52	0
52	-4.37500	-7.57772	0.01000	2.50000	0.	-120.00000	0.00300	51	52	53	0
53	-5.62500	-9.74279	0.01000	2.50000	0.	-120.00000	0.00300	52	53	54	0
54	-6.87500	-11.90785	0.01000	2.50000	0.	-120.00000	0.00300	53	54	55	0
55	-8.12500	-14.07291	0.01000	2.50000	0.	-120.00000	0.00300	54	55	56	0
56	-9.37500	-16.23798	0.01000	2.50000	0.	-120.00000	0.00300	55	56	57	0
57	-10.62500	-18.40304	0.01000	2.50000	0.	-120.00000	0.00300	56	57	58	0
58	-11.87500	-20.56810	0.01000	2.50000	0.	-120.00000	0.00300	57	58	59	0
59	-13.12500	-22.73317	0.01000	2.50000	0.	-120.00000	0.00300	58	59	60	0
60	-14.37500	-24.89823	0.01000	2.50000	0.	-120.00000	0.00300	59	60	0	0
61	0.62500	-1.08253	0.01000	2.50000	0.	-60.00000	0.00300	-1	61	62	0
62	1.87500	-3.24760	0.01000	2.50000	0.	-60.00000	0.00300	61	62	63	0
63	3.12500	-5.41266	0.01000	2.50000	0.	-60.00000	0.00300	62	63	64	0
64	4.37500	-7.57772	0.01000	2.50000	0.	-60.00000	0.00300	63	64	65	0
65	5.62500	-9.74279	0.01000	2.50000	0.	-60.00000	0.00300	64	65	66	0
66	6.87500	-11.90785	0.01000	2.50000	0.	-60.00000	0.00300	65	66	67	0
67	8.12500	-14.07291	0.01000	2.50000	0.	-60.00000	0.00300	66	67	68	0
68	9.37500	-16.23798	0.01000	2.50000	0.	-60.00000	0.00300	67	68	69	0
69	10.62500	-18.40304	0.01000	2.50000	0.	-60.00000	0.00300	68	69	70	0
70	11.87500	-20.56810	0.01000	2.50000	0.	-60.00000	0.00300	69	70	71	0
71	13.12500	-22.73317	0.01000	2.50000	0.	-60.00000	0.00300	70	71	72	0
72	14.37500	-24.89823	0.01000	2.50000	0.	-60.00000	0.00300	71	72	0	0

***** DATA CARD NO. 1 FR 0 1 0 0 1.00000E+01 0. 0. 0. 0.
 ***** DATA CARD NO. 2 GN 2 0 0 0 4.00000E+00 1.00000E-03 0. 0. 0.
 ***** DATA CARD NO. 3 WG -0 -0 -0 -0 0. 0. 0. 0. 0.

----- FREQUENCY -----

FREQUENCY= 1.0000E+01 MHZ
 WAVELENGTH= 2.9980E+01 METERS

APPROXIMATE INTEGRATION EMPLOYED FOR SEGMENTS MORE THAN 1.000 WAVELENGTHS APART

----- STRUCTURE IMPEDANCE LOADING -----

THIS STRUCTURE IS NOT LOADED

----- ANTENNA ENVIRONMENT -----

FINITE GROUND, SOMMERFELD SOLUTION
 RELATIVE DIELECTRIC CONST.= 4.000
 CONDUCTIVITY= 1.000E-03 MHOS/METER
 COMPLEX DIELECTRIC CONSTANT= 4.00000E+00-1.79760E+00

- - - MATRIX TIMING - - -

FILL= 1.687 SEC., FACTOR= 0.032 SEC.

****NUMERICAL GREEN'S FUNCTION FILE ON TAPE 20 ****
MATRIX STORAGE - 864 COMPLEX NUMBERS

***** DATA CARD NO. 4 NX -0 -0 -0 -0 0. 0. 0. 0. 0. 0.

NUMERICAL ELECTROMAGNETICS CODE

- - - - COMMENTS - - - -

MONOPOLE ON RADIAL WIRE GROUND SCREEN.

**
** NUMERICAL GREEN'S FUNCTION **
** NO. SEGMENTS = 72 NO. PATCHES = 0 **
** NO. SYMMETRIC SECTIONS = 6 **
** N.G.F. MATRIX - CORE STORAGE = 864 COMPLEX NUMBERS, CASE 2 **
** FREQUENCY = 1.00000E+01 MHZ. **
** FINITE GROUND, SOMMERFELD SOLUTION **
** GROUND PARAMETERS - DIELECTRIC CONSTANT = 4.00000E+00 **
** CONDUCTIVITY = 1.00000E-03 MHOS/M. **
**
** GREEN'S FUNCTION FOR RADIAL WIRE SCREEN OVER FINITE GROUND **
** SCREEN RADIUS = 30. M (1. WAVELENGTH RADIUS) **
** SCREEN HEIGHT = .01 M 6 RADIAL WIRES **
**

- - - STRUCTURE SPECIFICATION - - -

COORDINATES MUST BE INPUT IN METERS OR BE SCALED TO METERS BEFORE STRUCTURE INPUT IS ENDED

WIRE NO.	X1	Y1	Z1	X2	Y2	Z2	RADIUS	NO. OF SEG.	FIRST SEG.	LAST SEG.	TAG NO.
1	0.	0.	0.01000	0.	0.	7.51000	0.00300	6	73	78	1

GROUND PLANE SPECIFIED.

WHERE WIRE ENDS TOUCH GROUND, CURRENT WILL BE INTERPOLATED TO IMAGE IN GROUND PLANE.

TOTAL SEGMENTS USED= 78 NO. SEG. IN A SYMMETRIC CELL= 78 SYMMETRY FLAG= 0

- MULTIPLE WIRE JUNCTIONS -

JUNCTION	SEGMENTS (- FOR END 1, + FOR END 2)
1	-1 -13 -25 -37 -49 -61 -73

- - - - SEGMENTATION DATA - - - -

COORDINATES IN METERS

1+ AND 1- INDICATE THE SEGMENTS BEFORE AND AFTER I

SEG. NO.	COORDINATES OF SEG. CENTER			SEG. LENGTH	ORIENTATION ANGLES		WIRE RADIUS	CONNECTION DATA			TAG NO.
	X	Y	Z		ALPHA	BETA		1-	I	1+	
1	1.25000	0.	0.01000	2.50000	-0.00000	0.	0.00300	-13	1	2	0
2	3.75000	0.	0.01000	2.50000	0.	0.	0.00300	1	2	3	0
3	6.25000	0.	0.01000	2.50000	0.	0.	0.00300	2	3	4	0
4	8.75000	0.	0.01000	2.50000	0.	0.	0.00300	3	4	5	0
5	11.25000	0.	0.01000	2.50000	0.	0.	0.00300	4	5	6	0
6	13.75000	0.	0.01000	2.50000	0.	0.	0.00300	5	6	7	0
7	16.25000	0.	0.01000	2.50000	0.	0.	0.00300	6	7	8	0
8	18.75000	0.	0.01000	2.50000	0.	0.	0.00300	7	8	9	0
9	21.25000	0.	0.01000	2.50000	0.	0.	0.00300	8	9	10	0
10	23.75000	0.	0.01000	2.50000	0.	0.	0.00300	9	10	11	0
11	26.25000	0.	0.01000	2.50000	0.	0.	0.00300	10	11	12	0
12	28.75000	0.	0.01000	2.50000	0.	0.	0.00300	11	12	0	0
13	0.62500	1.08253	0.01000	2.50000	-0.00000	60.00000	0.00300	-25	13	14	0
14	1.87500	3.24760	0.01000	2.50000	0.	60.00000	0.00300	13	14	15	0
15	3.12500	5.41266	0.01000	2.50000	0.	60.00000	0.00300	14	15	16	0
16	4.37500	7.57772	0.01000	2.50000	0.	60.00000	0.00300	15	16	17	0
17	5.62500	9.74279	0.01000	2.50000	0.	60.00000	0.00300	16	17	18	0
18	6.87500	11.90785	0.01000	2.50000	0.	60.00000	0.00300	17	18	19	0
19	8.12500	14.07291	0.01000	2.50000	0.	60.00000	0.00300	18	19	20	0
20	9.37500	16.23798	0.01000	2.50000	0.	60.00000	0.00300	19	20	21	0
21	10.62500	18.40304	0.01000	2.50000	0.	60.00000	0.00300	20	21	22	0
22	11.87500	20.56810	0.01000	2.50000	0.	60.00000	0.00300	21	22	23	0
23	13.12500	22.73317	0.01000	2.50000	0.	60.00000	0.00300	22	23	24	0
24	14.37500	24.89823	0.01000	2.50000	0.	60.00000	0.00300	23	24	0	0
25	-0.62500	1.08253	0.01000	2.50000	-0.00000	120.00000	0.00300	-37	25	26	0
26	-1.87500	3.24760	0.01000	2.50000	0.	120.00000	0.00300	25	26	27	0
27	-3.12500	5.41266	0.01000	2.50000	0.	120.00000	0.00300	26	27	28	0
28	-4.37500	7.57772	0.01000	2.50000	0.	120.00000	0.00300	27	28	29	0
29	-5.62500	9.74279	0.01000	2.50000	0.	120.00000	0.00300	28	29	30	0
30	-6.87500	11.90785	0.01000	2.50000	0.	120.00000	0.00300	29	30	31	0
31	-8.12500	14.07291	0.01000	2.50000	0.	120.00000	0.00300	30	31	32	0
32	-9.37500	16.23798	0.01000	2.50000	0.	120.00000	0.00300	31	32	33	0
33	-10.62500	18.40304	0.01000	2.50000	0.	120.00000	0.00300	32	33	34	0
34	-11.87500	20.56810	0.01000	2.50000	0.	120.00000	0.00300	33	34	35	0
35	-13.12500	22.73317	0.01000	2.50000	0.	120.00000	0.00300	34	35	36	0
36	-14.37500	24.89823	0.01000	2.50000	0.	120.00000	0.00300	35	36	0	0
37	-1.25000	-0.00000	0.01000	2.50000	-0.00000	-180.00000	0.00300	-49	37	38	0
38	-3.75000	-0.00000	0.01000	2.50000	0.	-180.00000	0.00300	37	38	39	0
39	-6.25000	-0.00000	0.01000	2.50000	0.	-180.00000	0.00300	38	39	40	0
40	-8.75000	-0.00000	0.01000	2.50000	0.	-180.00000	0.00300	39	40	41	0
41	-11.25000	-0.00000	0.01000	2.50000	0.	-180.00000	0.00300	40	41	42	0
42	-13.75000	-0.00000	0.01000	2.50000	0.	-180.00000	0.00300	41	42	43	0
43	-16.25000	-0.00000	0.01000	2.50000	0.	-180.00000	0.00300	42	43	44	0
44	-18.75000	-0.00000	0.01000	2.50000	0.	-180.00000	0.00300	43	44	45	0
45	-21.25000	-0.00000	0.01000	2.50000	0.	-180.00000	0.00300	44	45	46	0
46	-23.75000	0.00000	0.01000	2.50000	0.	-180.00000	0.00300	45	46	47	0
47	-26.25000	-0.00000	0.01000	2.50000	0.	-180.00000	0.00300	46	47	48	0
48	-28.75000	-0.00000	0.01000	2.50000	0.	-180.00000	0.00300	47	48	0	0
49	-0.62500	-1.08253	0.01000	2.50000	-0.00000	-120.00000	0.00300	-61	49	50	0
50	-1.87500	-3.24760	0.01000	2.50000	0.	-120.00000	0.00300	49	50	51	0
51	-3.12500	-5.41266	0.01000	2.50000	0.	-120.00000	0.00300	50	51	52	0
52	-4.37500	-7.57772	0.01000	2.50000	0.	-120.00000	0.00300	51	52	53	0
53	-5.62500	-9.74279	0.01000	2.50000	0.	-120.00000	0.00300	52	53	54	0
54	-6.87500	-11.90785	0.01000	2.50000	0.	-120.00000	0.00300	53	54	55	0
55	-8.12500	-14.07291	0.01000	2.50000	0.	-120.00000	0.00300	54	55	56	0
56	-9.37500	-16.23798	0.01000	2.50000	0.	-120.00000	0.00300	55	56	57	0
57	-10.62500	-18.40304	0.01000	2.50000	0.	-120.00000	0.00300	56	57	58	0
58	-11.87500	-20.56810	0.01000	2.50000	0.	-120.00000	0.00300	57	58	59	0
59	-13.12500	-22.73317	0.01000	2.50000	0.	-120.00000	0.00300	58	59	60	0
60	-14.37500	-24.89823	0.01000	2.50000	0.	-120.00000	0.00300	59	60	0	0
61	0.62500	-1.08253	0.01000	2.50000	-0.00000	-60.00000	0.00300	-73	61	62	0
62	1.87500	-3.24760	0.01000	2.50000	0.	-60.00000	0.00300	61	62	63	0
63	3.12500	-5.41266	0.01000	2.50000	0.	-60.00000	0.00300	62	63	64	0
64	4.37500	-7.57772	0.01000	2.50000	0.	-60.00000	0.00300	63	64	65	0
65	5.62500	-9.74279	0.01000	2.50000	0.	-60.00000	0.00300	64	65	66	0
66	6.87500	-11.90785	0.01000	2.50000	0.	-60.00000	0.00300	65	66	67	0
67	8.12500	-14.07291	0.01000	2.50000	0.	-60.00000	0.00300	66	67	68	0
68	9.37500	-16.23798	0.01000	2.50000	0.	-60.00000	0.00300	67	68	69	0
69	10.62500	-18.40304	0.01000	2.50000	0.	-60.00000	0.00300	68	69	70	0
70	11.87500	-20.56810	0.01000	2.50000	0.	-60.00000	0.00300	69	70	71	0

71	13.12500	-22.73317	0.01000	2.50000	0.	-60.00000	0.00300	70	71	72	0
72	14.37500	-24.89823	0.01000	2.50000	0.	-60.00000	0.00300	71	72	0	0
73	0.00000	0.	0.63500	1.25000	90.00000	180.00000	0.00300	-1	73	74	1
74	0.	0.	1.89500	1.25000	90.00000	0.	0.00300	73	74	75	1
75	0.	0.	3.13500	1.25000	90.00000	0.	0.00300	74	75	76	1
76	0.	0.	4.38500	1.25000	90.00000	0.	0.00300	75	76	77	1
77	0.	0.	5.63500	1.25000	90.00000	0.	0.00300	76	77	78	1
78	0.	0.	6.88500	1.25000	90.00000	0.	0.00300	77	78	0	1

N.G.F. - NUMBER OF NEW UNKNOWN IS 12

***** DATA CARD NO. 1 EX 0 1 1 0 1.00000E+00 0. 0. 0. 0.
 ***** DATA CARD NO. 2 RP 0 19 2 1001 0. 0. 5.00000E+00 9.00000E+01 0. 0.

----- FREQUENCY -----

FREQUENCY= 1.0000E+01 MHZ
 WAVELENGTH= 2.9980E+01 METERS

APPROXIMATE INTEGRATION EMPLOYED FOR SEGMENTS MORE THAN 1.000 WAVELENGTHS APART

--- STRUCTURE IMPEDANCE LOADING ---

THIS STRUCTURE IS NOT LOADED

--- ANTENNA ENVIRONMENT ---

FINITE GROUND, SOMMERFELD SOLUTION
 RELATIVE DIELECTRIC CONST.= 4.000
 CONDUCTIVITY= 1.000E-03 MHOS/METER
 COMPLEX DIELECTRIC CONSTANT= 4.00000E+00-1.79760E+00

--- MATRIX TIMING ---

FILL= 3.682 SEC., FACTOR= 0.199 SEC.

--- ANTENNA INPUT PARAMETERS ---

TAG NO.	SEG. NO.	VOLTAGE (VOLTS)		CURRENT (AMPS)		IMPEDANCE (OHMS)		ADMITTANCE (MHOS)		POWER
		REAL	IMAG.	REAL	IMAG.	REAL	IMAG.	REAL	IMAG.	(WATTS)
1	73	1.00000E+00	0.	1.02942E-02	-2.09643E-03	9.32739E+01	1.89954E+01	1.02942E-02	-2.09643E-03	5.14709E-03

--- CURRENTS AND LOCATION ---

DISTANCES IN WAVELENGTHS

SEG. NO.	TAG NO.	COORD. OF SEG. CENTER			SEG. LENGTH	CURRENT (AMPS)			PHASE
		X	Y	Z		REAL	IMAG	MAG.	
1	0	0.0417	0.	0.0003	0.08339	-1.6169E-03	6.4601E-04	1.7411E-03	158.221
2	0	0.1251	0.	0.0003	0.08339	-1.0095E-03	1.1150E-03	1.5041E-03	132.155
3	0	0.2085	0.	0.0003	0.08339	-7.9255E-05	1.1866E-03	1.1892E-03	93.821
4	0	0.2919	0.	0.0003	0.08339	8.1553E-04	8.3826E-04	1.1695E-03	45.788
5	0	0.3753	0.	0.0003	0.08339	1.3339E-03	2.6378E-04	1.3596E-03	11.186
6	0	0.4586	0.	0.0003	0.08339	1.2978E-03	-2.6927E-04	1.3254E-03	-11.722
7	0	0.5420	0.	0.0003	0.08339	7.5781E-04	-5.5815E-04	9.4117E-04	-36.373
8	0	0.6254	0.	0.0003	0.08339	-3.7594E-05	-5.5184E-04	5.5292E-04	-93.899
9	0	0.7088	0.	0.0003	0.08339	-7.5140E-04	-3.4775E-04	8.2797E-04	-155.165
10	0	0.7922	0.	0.0003	0.08339	-1.0969E-03	-1.1390E-04	1.1028E-03	-174.072
11	0	0.8756	0.	0.0003	0.08339	-9.4915E-04	1.8517E-05	9.4933E-04	178.882

12	0	0.9590	0.	0.0003	0.08339	-3.8115E-04	2.3433E-05	3.8187E-04	176.482
13	0	0.0208	0.0361	0.0003	0.08339	-1.6169E-03	6.4601E-04	1.7411E-03	158.221
14	0	0.0625	0.1083	0.0003	0.08339	-1.0095E-03	1.1150E-03	1.5041E-03	132.155
15	0	0.1042	0.1805	0.0003	0.08339	-7.9255E-05	1.1866E-03	1.1892E-03	93.821
16	0	0.1459	0.2528	0.0003	0.08339	8.1553E-04	8.3826E-04	1.1695E-03	45.788
17	0	0.1876	0.3250	0.0003	0.08339	1.3339E-03	2.6378E-04	1.3598E-03	11.186
18	0	0.2293	0.3972	0.0003	0.08339	1.2978E-03	-2.6927E-04	1.3254E-03	-11.722
19	0	0.2710	0.4694	0.0003	0.08339	7.5781E-04	-5.5815E-04	9.4117E-04	-36.373
20	0	0.3127	0.5416	0.0003	0.08339	-3.7594E-05	-5.5164E-04	5.5292E-04	-93.899
21	0	0.3544	0.6138	0.0003	0.08339	-7.5140E-04	-3.4775E-04	8.2797E-04	-155.165
22	0	0.3961	0.6861	0.0003	0.08339	-1.0969E-03	-1.1390E-04	1.1028E-03	-174.072
23	0	0.4378	0.7583	0.0003	0.08339	-9.4915E-04	1.8517E-05	9.4933E-04	178.882
24	0	0.4795	0.8305	0.0003	0.08339	-3.8115E-04	2.3433E-05	3.8187E-04	176.482
25	J	-0.0208	0.0361	0.0003	0.08339	-1.6169E-03	6.4601E-04	1.7411E-03	158.221
26	0	-0.0625	0.1083	0.0003	0.08339	-1.0095E-03	1.1150E-03	1.5041E-03	132.155
27	0	-0.1042	0.1805	0.0003	0.08339	-7.9255E-05	1.1866E-03	1.1892E-03	93.821
28	0	-0.1459	0.2528	0.0003	0.08339	8.1553E-04	8.3826E-04	1.1695E-03	45.788
29	0	-0.1876	0.3250	0.0003	0.08339	1.3339E-03	2.6378E-04	1.3598E-03	11.186
30	0	-0.2293	0.3972	0.0003	0.08339	1.2978E-03	-2.6927E-04	1.3254E-03	-11.722
31	0	-0.2710	0.4694	0.0003	0.08339	7.5781E-04	-5.5815E-04	9.4117E-04	-36.373
32	0	-0.3127	0.5416	0.0003	0.08339	-3.7594E-05	-5.5164E-04	5.5292E-04	-93.899
33	0	-0.3544	0.6138	0.0003	0.08339	-7.5140E-04	-3.4775E-04	8.2797E-04	-155.165
34	0	-0.3961	0.6861	0.0003	0.08339	-1.0969E-03	-1.1390E-04	1.1028E-03	-174.072
35	0	-0.4378	0.7583	0.0003	0.08339	-9.4915E-04	1.8517E-05	9.4933E-04	178.882
36	0	-0.4795	0.8305	0.0003	0.08339	-3.8115E-04	2.3433E-05	3.8187E-04	176.482
37	0	-0.0417	-0.0000	0.0003	0.08339	-1.6169E-03	6.4601E-04	1.7411E-03	158.221
38	0	-0.1251	-0.0000	0.0003	0.08339	-1.0095E-03	1.1150E-03	1.5041E-03	132.155
39	0	-0.2085	-0.0000	0.0003	0.08339	-7.9255E-05	1.1866E-03	1.1892E-03	93.821
40	0	-0.2919	-0.0000	0.0003	0.08339	8.1553E-04	8.3826E-04	1.1695E-03	45.788
41	0	-0.3753	-0.0000	0.0003	0.08339	1.3339E-03	2.6378E-04	1.3598E-03	11.186
42	0	-0.4586	-0.0000	0.0002	0.08339	1.2978E-03	-2.6927E-04	1.3254E-03	-11.722
43	0	-0.5420	-0.0000	0.0003	0.08339	7.5781E-04	-5.5815E-04	9.4117E-04	-36.373
44	0	-0.6254	-0.0000	0.0003	0.08339	-3.7594E-05	-5.5164E-04	5.5292E-04	-93.899
45	0	-0.7088	-0.0000	0.0003	0.08339	-7.5140E-04	-3.4775E-04	8.2797E-04	-155.165
46	0	-0.7922	-0.0000	0.0003	0.08339	-1.0969E-03	-1.1390E-04	1.1028E-03	-174.072
47	0	-0.8756	-0.0000	0.0003	0.08339	-9.4915E-04	1.8517E-05	9.4933E-04	178.882
48	0	-0.9590	-0.0000	0.0003	0.08339	-3.8115E-04	2.3433E-05	3.8187E-04	176.482
49	0	-0.0208	-0.0361	0.0003	0.08339	-1.6169E-03	6.4601E-04	1.7411E-03	158.221
50	0	-0.0625	-0.1083	0.0003	0.08339	-1.0095E-03	1.1150E-03	1.5041E-03	132.155
51	0	-0.1042	-0.1805	0.0003	0.08339	-7.9255E-05	1.1866E-03	1.1892E-03	93.821
52	0	-0.1459	-0.2528	0.0003	0.08339	8.1553E-04	8.3826E-04	1.1695E-03	45.788
53	0	-0.1876	-0.3250	0.0003	0.08339	1.3339E-03	2.6378E-04	1.3598E-03	11.186
54	0	-0.2293	-0.3972	0.0003	0.08339	1.2978E-03	-2.6927E-04	1.3254E-03	-11.722
55	0	-0.2710	-0.4694	0.0003	0.08339	7.5781E-04	-5.5815E-04	9.4117E-04	-36.373
56	0	-0.3127	-0.5416	0.0003	0.08339	-3.7594E-05	-5.5164E-04	5.5292E-04	-93.899
57	0	-0.3544	-0.6138	0.0003	0.08339	-7.5140E-04	-3.4775E-04	8.2797E-04	-155.165
58	0	-0.3961	-0.6861	0.0003	0.08339	-1.0969E-03	-1.1390E-04	1.1028E-03	-174.072
59	0	-0.4378	-0.7583	0.0003	0.08339	-9.4915E-04	1.8517E-05	9.4933E-04	178.882
60	0	-0.4795	-0.8305	0.0003	0.08339	-3.8115E-04	2.3433E-05	3.8187E-04	176.482
61	0	0.0208	0.0361	0.0003	0.08339	-1.6169E-03	6.4601E-04	1.7411E-03	158.221
62	0	0.0625	0.1083	0.0003	0.08339	-1.0095E-03	1.1150E-03	1.5041E-03	132.155
63	0	0.1042	0.1805	0.0003	0.08339	-7.9255E-05	1.1866E-03	1.1892E-03	93.821
64	0	0.1459	0.2528	0.0003	0.08339	8.1553E-04	8.3826E-04	1.1695E-03	45.788
65	0	0.1876	0.3250	0.0003	0.08339	1.3339E-03	2.6378E-04	1.3598E-03	11.186
66	0	0.2293	0.3972	0.0003	0.08339	1.2978E-03	-2.6927E-04	1.3254E-03	-11.722
67	0	0.2710	0.4694	0.0003	0.08339	7.5781E-04	-5.5815E-04	9.4117E-04	-36.373
68	0	0.3127	0.5416	0.0003	0.08339	-3.7594E-05	-5.5164E-04	5.5292E-04	-93.899
69	0	0.3544	0.6138	0.0003	0.08339	-7.5140E-04	-3.4775E-04	8.2797E-04	-155.165
70	0	0.3961	0.6861	0.0003	0.08339	-1.0969E-03	-1.1390E-04	1.1028E-03	-174.072
71	0	0.4378	0.7583	0.0003	0.08339	-9.4915E-04	1.8517E-05	9.4933E-04	178.882
72	0	0.4795	0.8305	0.0003	0.08339	-3.8115E-04	2.3433E-05	3.8187E-04	176.482
73	I	0.0000	0.	0.0212	0.04169	1.0294E-02	-2.0964E-03	1.0505E-02	-11.511
74	I	0.	0.	0.0629	0.04169	9.6470E-03	-2.1746E-03	9.8890E-03	-12.703
75	I	0.	0.	0.1046	0.04169	8.3683E-03	-2.0633E-03	9.6190E-03	-13.851
76	I	0.	0.	0.1463	0.04169	6.5356E-03	-1.7166E-03	6.7573E-03	-14.717
77	I	0.	0.	0.1880	0.04169	4.2450E-03	-1.1713E-03	4.4037E-03	-15.426
78	I	0.	0.	0.2297	0.04169	1.5535E-03	-4.4633E-04	1.6164E-03	-16.030

- - - POWER BUDGET - - -

INPUT POWER = 5.1471E-03 WATTS
RADIATED POWER= 5.1471E-03 WATTS
STRUCTURE LOSS= 0. WATTS
NETWORK LOSS = 0. WATTS
EFFICIENCY = 100.00 PERCENT

- - - RADIATION PATTERNS - - -

- - ANGLES - -		- POWER GAINS -			- - - POLARIZATION - - -			- - - E(THETA) - - -		- - - E(PHI) - - -	
THETA	PHI	VERT.	HOR.	TOTAL	AXIAL	TILT	SENSE	MAGNITUDE	PHASE	MAGNITUDE	PHASE
DEGREES	DEGREES	DB	DB	DB	RATIO	DEG.		VOLTS/M	DEGREES	VOLTS/M	DEGREE\$
0.	0.	-999.99	-999.99	-999.99	0.	0.		1.61865E-11	37.56	8.44822E-12	-146.69
5.00	0.	-26.04	-999.99	-26.04	0.00000	0.00	LINEAR	2.77183E-02	126.17	6.17132E-12	-151.29
10.00	0.	-20.19	-999.99	-20.19	0.00000	0.00	LINEAR	5.43691E-02	120.49	5.35094E-12	-176.12
15.00	0.	-16.75	-999.99	-16.75	0.00000	0.00	LINEAR	8.07566E-02	111.86	7.75391E-12	-164.15
20.00	0.	-14.10	-999.99	-14.10	0.00000	0.00	LINEAR	1.09587E-01	101.96	1.25335E-11	-164.72
25.00	0.	-11.77	-999.99	-11.77	0.00000	0.00	LINEAR	1.43261E-01	92.77	1.93374E-11	-173.32
30.00	0.	-9.71	-999.99	-9.71	0.00000	-0.00	LINEAR	1.81702E-01	85.57	2.84348E-11	-176.97
35.00	0.	-7.95	-999.99	-7.95	0.00000	-0.00	LINEAR	2.22369E-01	80.61	3.96421E-11	-168.65
40.00	0.	-6.54	-999.99	-6.54	0.00000	-0.00	LINEAR	2.61698E-01	77.57	5.20404E-11	-162.17
45.00	0.	-5.46	-198.75	-5.46	0.00000	-0.00	LINEAR	2.96337E-01	75.96	6.41899E-11	-157.24
50.00	0.	-4.69	-197.45	-4.69	0.00000	-0.00	LINEAR	3.23752E-01	75.34	7.44822E-11	-153.46
55.00	0.	-4.21	-196.67	-4.21	0.00000	-0.00	LINEAR	3.41961E-01	75.32	8.14777E-11	-150.50
60.00	0.	-4.03	-196.40	-4.03	0.00000	-0.00	LINEAR	3.49384E-01	75.62	8.41145E-11	-148.11
65.00	0.	-4.16	-196.64	-4.16	0.00000	-0.00	LINEAR	3.44228E-01	76.01	8.17836E-11	-146.12
70.00	0.	-4.68	-197.47	-4.68	0.00000	-0.00	LINEAR	3.24301E-01	76.31	7.43167E-11	-144.43
75.00	0.	-5.76	-199.06	-5.76	0.00000	-0.00	LINEAR	2.86378E-01	76.40	6.18939E-11	-142.99
80.00	0.	-7.83	-999.99	-7.83	0.00000	-0.00	LINEAR	2.25657E-01	76.16	4.49434E-11	-141.76
85.00	0.	-12.32	-999.99	-12.32	0.00000	-0.00	LINEAR	1.34532E-01	75.45	2.40829E-11	-140.73
90.00	0.	-999.99	-999.99	-999.99	0.	0.		9.53821E-12	-105.90	7.50697E-16	3.72
0.	90.00	-999.99	-999.99	-999.99	0.	0.		8.44822E-12	-146.69	1.61865E-11	-142.44
5.00	90.00	-26.04	-999.99	-26.04	0.00000	0.00	LINEAR	2.77176E-02	126.17	1.84015E-11	-145.19
10.00	90.00	-20.19	-999.99	-20.19	0.00000	-0.00	LINEAR	5.43551E-02	120.43	2.04294E-11	-149.26
15.00	90.00	-16.76	-999.99	-16.76	0.00000	-0.00	LINEAR	8.07181E-02	111.59	2.20686E-11	-154.58
20.00	90.00	-14.09	-999.99	-14.09	0.00000	-0.00	LINEAR	1.09697E-01	101.22	2.29086E-11	-161.30
25.00	90.00	-11.72	-999.99	-11.72	0.00000	-0.00	LINEAR	1.44158E-01	91.35	2.24657E-11	-170.02
30.00	90.00	-9.57	-999.99	-9.57	0.00000	-0.00	LINEAR	1.84495E-01	83.40	2.05347E-11	-177.78
35.00	90.00	-7.72	-999.99	-7.72	0.00000	0.00	LINEAR	2.28292E-01	77.72	1.77110E-11	-158.88
40.00	90.00	-6.21	-999.99	-6.21	0.00000	0.00	LINEAR	2.71664E-01	74.03	1.60254E-11	-129.90
45.00	90.00	-5.05	-999.99	-5.05	0.00000	0.00	LINEAR	3.10857E-01	71.87	1.80433E-11	-97.89
50.00	90.00	-4.21	-999.99	-4.21	0.00000	0.00	LINEAR	3.41991E-01	70.80	2.32437E-11	-75.44
55.00	90.00	-3.69	-999.99	-3.69	0.00000	0.00	LINEAR	3.63178E-01	70.45	2.90263E-11	-62.27
60.00	90.00	-3.48	-999.99	-3.48	0.00000	0.00	LINEAR	3.72261E-01	70.53	3.34084E-11	-54.41
65.00	90.00	-3.59	-999.99	-3.59	0.00000	0.00	LINEAR	3.67380E-01	70.81	3.52487E-11	-49.50
70.00	90.00	-4.11	-999.99	-4.11	0.00000	0.00	LINEAR	3.46274E-01	71.09	3.39951E-11	-46.41
75.00	90.00	-5.19	-999.99	-5.19	0.00000	0.00	LINEAR	3.05727E-01	71.21	2.95261E-11	-44.53
80.00	90.00	-7.26	-999.99	-7.26	0.00000	0.00	LINEAR	2.40804E-01	71.01	2.26429E-11	-43.56
85.00	90.00	-11.76	-999.99	-11.76	0.00000	0.00	LINEAR	1.43511E-01	70.34	1.19917E-11	-43.33
90.00	90.00	-999.99	-999.99	-999.99	0.	0.		1.01736E-11	-111.00	1.22099E-15	61.39

AVERAGE POWER GAIN= 2.40245E-01

SOLID ANGLE USED IN AVERAGING=(0.5000)*PI STERADIANS.

***** DATA CARD NO. 3 EN -0 -0 -0 -0 0. 0. 0. 0. 0. 0.

RUN TIME = 6.778

Section V Execution Time

The program execution time depends on the number of patches and the number of wire segments used. The central processor time approximately follows the formula

$$\begin{aligned}
 T &= T_1 + T_2 + T_3 + T_4, \\
 T_1 &= (A_1 k N_s^2 + A_2 k N_p^2 + A_3 k N_s N_p + A_4 N_c) / M, \\
 T_2 &= B (N_s + 2N_p)^3 / M^2, \\
 T_3 &= C N_e (N_s + 2N_p)^2 / M, \\
 T_4 &= D k N_f (N_s + 2N_p),
 \end{aligned}$$

where

- N_s = number of wire segments,
- N_p = number of surface patches,
- N_c = number of connections between a wire and a surface,
- N_e = number of different excitations,
- N_f = number of far-field calculation points,
- M = number of degrees of symmetry,
- k = 1 for structure in free space,
 2 for perfect ground or reflection coefficient approximation, and
 4 for Sommerfeld/Norton method.

T_1 is the time to fill the interaction matrix; T_2 is the time to factor the matrix; T_3 is the time to solve for the currents for all excitations; and T_4 is the time to calculate far fields.

The proportionality factors depend on the computer system on which the program is run. The factors in seconds for a CDC 7600 computer when the matrix fits in core are roughly

$$\begin{aligned}
 A_1 &= 3. (10^{-4}), \\
 A_2 &= 5. (10^{-5}), \\
 A_3 &= 5. (10^{-4}), \\
 A_4 &= 2. (10^{-2}), \\
 B &= 2. (10^{-6}), \\
 C &= 4. (10^{-6}), \text{ and} \\
 D &= 6. (10^{-5}).
 \end{aligned}$$

When the extended thin-wire kernel is used, A_1 is increased by about 18 percent. If the approximation for large interaction distances is used with $R_{KH} = R_0$, then A_1 is multiplied by $(1. - 0.7F)$ where F is the fraction of all segment pairs for which the separation is greater than R_0 .

Unless a large number of excitations or far fields are requested, T_1 and T_2 will account for nearly all of the running time. If the matrix does not fit in core storage, T_1 and T_2 will be larger than indicated above. They may be much larger if I/O time is included.

The code SOMNEC requires about 15 sec to write the Sommerfeld/Norton data file on a CDC 7600 computer.

Section VI

Differences Between NEC-2, NEC-1, and AMP2

The following are features of the NEC-1 code that differ from AMP2:

- A new current expansion is used with continuous current and current derivative along wires. The expansion enforces new conditions at multiple-wire junctions and allows for current flowing onto the end cap at an open wire end.
- Where a wire connects to a surface, the surface-current expansion is related to the current at the base of the wire rather than at the center of the last wire segment.
- An optional voltage source based on a discontinuity in current slope is available.
- In the thin-wire approximation, the current filament is on the wire axis and the observation points are on the surface.
- An optional extended thin-wire approximation is available.
- Either a perfectly or imperfectly conducting ground may be used with surface patches.
- Either a perfect or imperfect ground may be used with an incident plane wave.
- Some constants have been changed including the velocity of light (2.998×10^8 m/sec.) and the default frequency (299.8 MHz).
- The wire-segment connection numbers have new meanings.
- The radiated field is the field at a range R multiplied by R, with R approaching infinity. In AMP and AMP2, the field is multiplied by R/λ .
- Both near electric and magnetic fields may be computed. The NF card is no longer used.
- Charge density may be printed for wires.
- The PT card is no longer cancelled by a new EX card.

The following are features of NEC-2 that differ from NEC-1:

- The NGF option has been added.
- The restart option has been removed.
- The Sommerfeld/Norton method has been added.
- Maximum coupling between antennas may be computed.
- Wires may have tapered radius and segment lengths.
- Patches may be specified as triangles, rectangles, or quadrangles.
- Rectangular surfaces with multiple patches may be specified.
- The SS card for surfaces has been eliminated.

Section VII File Storage Requirements

Depending on the requirements of a run, NEC-2 may use the following files.

- 11, 12, 13, 14, 15, 16 - scratch files for matrix manipulations.
- 20 - NGF file.
- 21 - Sommerfeld/Norton data.

The scratch files are used only when the matrix will not fit into core storage. For a case that does not use the NGF (but may write a NGF file), there are five options for matrix storage. If

- N = the number of equations (number of segments plus twice the number of patches),
- N_x = the number of equations for a symmetric section, and
- I_R = number of complex numbers for the matrix in core storage (4000),

then the cases, indicated by the value of ICASE in the code, are:

ICASE

- 1 matrix in core, no symmetry ($N^2 \leq I_R$).
- 2 matrix in core, symmetry ($NN_x \leq I_R$).
- 3 matrix out of core, no symmetry ($N^2 > I_R$).
- 4 matrix out of core, symmetry, blocks fit in core ($NN_x > I_R$, $N_x^2 \leq I_R$).
- 5 matrix out of core, symmetry, blocks do not fit in core ($N_x^2 > I_R$).

File storage is used for cases 3, 4, and 5. Only the four files (11, 12, 13, and 14) are used when the NGF is not in use. The size of each file is approximately $2NN_x$ words. If the computer system requires that the user specify the file size, a safety margin should be included in the request. A more accurate estimate of the file size is

$$L = 2N N_c \left[\frac{N_x}{N_c} + 1 \right],$$

where

$$N_c = \left[\frac{I_R}{2N} \right]$$

and [] indicates truncation. N_c , which is the number of matrix columns in an I/O block, must be at least 1.

When the NGF is used, all six scratch files may be required. For the NGF the matrix is partitioned into four sections as

$$\begin{bmatrix} A & B \\ C & D \end{bmatrix}$$

A is the matrix for the NGF structure and is factored before the NGF file is written. The storage case for A is indicated in the NGF label by the value of ICASE (see example 10 in section IV). When the NGF is used, matrix A is read from file 20 and, if ICASE is 3, 4, or 5, is stored on file 13. The size of file 13 when the NGF is used is approximately:

<u>ICASE</u>	<u>Length of file 13</u>
3	$4N^2$
4	$2NN_x$
5	$4NN_x$

There are four options for storage of the matrices B, C, and D. These are associated with the integer ICASX as follows:

ICASX

- 1 A_R , B, C, and D fit in core together where
 $A_R = A$ for ICASE = 1 or 2,
 = one I/O block of A for ICASE = 3 or 5,
 = one submatrix for ICASE = 4.
- 2 B, C, and D fit in core but not with A_R . This is possible only for ICASE = 3, 4, or 5 when A does not need dedicated space in core. A_R and B must also fit in core together.
- 3 B, C, and D do not fit in core, but D fits in core alone. A and D must fit together if ICASE = 1 or 2.
- 4 D does not fit in core.

The sizes of matrices B, C, and D depend on the number of new unknowns N_n where

$$N_n = N_s + N_t + 2 N_p + 10 N_q ,$$

N_s = number of new segments added to NGF,

N_t = number of NGF segments connected to new segments or patches,
 N_p = number of new patches,
 N_q = number of NGF patches connected to new segments.

The sizes of matrices B and C are $2 N N_n$ and the size of D is $2 N_n^2$ words. The file lengths are approximately $2 N_n^2$ words for files 11 and 12, and $2 N N_n$ for files 14, 15, and 16. When ICASX is 1 these files are not used, and when ICASX is 2 file 16 is not used.

The length of the NGF file (20) is approximately $4 N (N_x + 3)$. The length of the Sommerfeld/Norton data file (21) is about 2200 words.

Section VIII Error Messages

1. CHECK DATA, PARAMETER SPECIFYING SEGMENT POSITION IN A GROUP OF EQUAL TAGS CANNOT BE ZERO.
Routine: ISEGNO
This error results from an input data error and may occur at any point where a tag number is used to identify a segment. Execution terminated. Data on the NT, TL, EX, and PT cards should be checked.
2. CONNECT - SEGMENT CONNECTION ERROR FOR SEGMENT __ .
Routine: CONNECT
Possible causes: number of segments at a junction exceeds limit; segment lengths are zero; array overflow.
3. DATA FAULT ON LOADING CARD NO. = __ ITAG STEP1 = __ IS GREATER THAN ITAG STEP2 = __ .
Routine: MAIN
When several segments are loaded, the number of the second segment specified must be greater than the number of the first segment. Execution terminated.
4. EOF ON UNIT __ NBLKS = __ NEOF = __ .
Routine: BLCKIN, entry point of BLCKOT
An end of file has been encountered while reading data from the unit. NBLKS determines how many records are read from the unit. NEOF is a flag to indicate which call to BLCKIN initiated the read. If NEOF = 777, this diagnostic is normal and execution will continue. Otherwise, an error is indicated and execution will terminate.
5. ERROR -- ARC ANGLE EXCEEDS 360. DEGREES
Routine: ARC
Error on GA card.
6. ERROR - B LESS THAN A IN ROM2
Routine: ROM2
Program malfunction.
7. ERROR - FR/GN CARD IS NOT ALLOWED WITH N.G.F.
Routine: Main
See section III-5.

8. ERROR -- CORNERS OF QUADRILATERAL PATCH DO NOT LIE IN A PLANE.
Routine: Patch
The four corners of a quadrilateral patch (SP card) must lie in a plane.
9. ERROR - COUPLING IS NOT BETWEEN 0 AND 1
Routine: Couple
Inaccuracy in solution or error in data.
10. ERROR - GF MUST BE FIRST GEOMETRY DATA CARD
Routine: DATAGN
See section III-5.
11. ERROR IN GROUND PARAMETERS - COMPLEX DIELECTRIC CONSTANT FROM FILE
IS _____ REQUESTED _____.
Routine: MAIN
Complex dielectric constant from file TAPE21 does not agree with data
from GN and FR cards.
12. ERROR - INSUFFICIENT STORAGE FOR INTERACTION MATRICES.
IRESRV, IMAT, NEQ, NEQ2 =
Routine: FBNGF
Array storage exceeded in NGF solution.
13. ERROR - INSUFFICIENT STORAGE FOR MATRIX
Routine: FBLOCK
Array storage for matrix is not sufficient for out-of-core solution.
14. ERROR - NETWORK ARRAY DIMENSIONS TOO SMALL.
Routine: NETWK
The number of different segments to which transmission lines or network
ports are connected exceeds array dimensions. Execution terminated.
Array size in the original NEC deck is 30. Refer to array dimension
limitations in Part II for changing array sizes.
15. ERROR - LOADING MAY NOT BE ADDED TO SEGMENTS IN N.G.F. SECTION
Routine: LOAD
See section III-5.
16. ERROR - N.G.F. IN USE. CANNOT WRITE NEW N.G.F.
Routine: MAIN

17. ERROR - NO. NEW SEGMENTS CONNECTED TO N.G.F. SEGMENTS OR PATCHES EXCEEDS LIMIT.
Routine: CONECT
Array dimension limit.
18. FAULTY DATA CARD LABEL AFTER GEOMETRY SECTION.
Routine: MAIN
A card with an unrecognizable mnemonic has been encountered in the program control cards following the geometry cards. Execution terminated.
19. GEOMETRY DATA CARD ERROR.
Routine: DATAGN
A geometry data card was expected, but the card mnemonic is not that of a geometry card. Execution terminated. After the GE card in a data deck, the possible geometry mnemonics are GE, GM, GR, GS, GW, GX, SP, and SS.
The GE card must be used to terminate the geometry cards.
20. GEOMETRY DATA ERROR - - PATCH __ LIES IN PLANE OF SYMMETRY.
Routine: REFLC
21. GEOMETRY DATA ERROR - - SEGMENT __ EXTENDS BELOW GROUND.
Routine: CONECT
When ground is specified on the GE card, no segment may extend below the XY plane. Execution terminated.
22. GEOMETRY DATA ERROR - - SEGMENT __ LIES IN GROUND PLANE.
Routine: CONECT
When ground is specified on the GE card, no segment should lie in the XY plane. Execution terminated.
23. GEOMETRY DATA ERROR - - SEGMENT __ LIES IN PLANE OF SYMMETRY.
Routine: REFLC
A segment may not lie in or cross a plane of symmetry about which the structure is reflected since the segment and its image will coincide or cross. Execution terminated.

24. IMPROPER LOAD TYPE CHOSEN, REQUESTED TYPE IS __ __.
Routine: LOAD
Valid load types (LDTYP on the LD card) are from 0 through 5.
Execution terminated.
25. INCORRECT LABEL FOR A COMMENT CARD.
Routine: MAIN
The program expected a comment card, with mnemonic CM or CE, but encountered a different mnemonic. Execution terminated. Comment cards must be the first cards in a data set, and the comments must be terminated by the CE mnemonic.
26. LOADING DATA CARD ERROR, NO SEGMENT HAS AN ITAG= __ __.
Routine: LOAD
ITAG specified on an LD card could not be found as a segment tag.
Execution terminated.
27. NO SEGMENT HAS AN ITAG OF __ __.
Routine: ISEGNO
This error results from faulty input data and can occur at any point where a tag number is used to identify a segment. Execution terminated. Tag numbers on the NT, TL, EX, CP, PQ, and PT cards should be checked.
28. NOTE, SOME OF THE ABOVE SEGMENTS HAVE BEEN LOADED TWICE, IMPEDANCES ADDED.
Routine: LOAD
A segment or segments have been loaded by two or more LD cards. The impedances of the loads have been added in series. This is only an informative message. Execution continues.
29. NUMBER OF EXCITATION CARDS EXCEEDS STORAGE ALLOTTED.
Routine: MAIN
The number of voltage source excitations exceeds array dimensions. Execution terminated. The dimensions in the original NEC deck allow 10 voltage sources. Refer to Array Dimension Limitations in Part II to change the dimensions.
30. NUMBER OF LOADING CARDS EXCEEDS STORAGE ALLOTTED.
Routine: MAIN
The number of LD cards exceeds array dimension. Execution terminated.

The dimension in the original NEC deck allows 30 LD cards. Refer to Part II to change the dimensions.

31. NUMBER OF NETWORK CARDS EXCEEDS STORAGE ALLOTTED.
Routine: MAIN
The number of NT and TL cards exceeds array dimension. Execution terminated. The dimension in the original NEC deck allows 30 cards. Refer to Array Dimension Limitations in Part II to change the dimensions.
32. NUMBER OF SEGMENTS IN COUPLING CALCULATION (CP) EXCEEDS LIMIT.
Routine: MAIN
Array dimension limit.
33. NUMBER OF SEGMENTS AND SURFACE PATCHES EXCEEDS DIMENSION LIMIT.
Routine: DATAGN
The sum of the number of segments and patches is limited by dimensions. The present limit is 300.
34. PATCH DATA ERROR.
Routine: DATAGN
Invalid data on SP, SM, or SC card; or SC card not found where required.
35. PIVOT(_ _) = _ _ .
Routine: FACTR (in-core) or LFACTR (out-of-core)
This will be printed during the Gauss Doolittle factoring of the interaction matrix or the network matrix when a pivot element less than 10^{-10} is encountered, and indicates that the matrix is nearly singular. The number in parentheses shows on which pass through the matrix the condition occurred. This is usually an abnormal condition although execution will continue. It may result from coinciding segments or a segment of zero length.
36. RADIAL WIRE G.S. APPROXIMATION MAY NOT BE USED WITH SOMMERFELD GROUND OPTION.
Routine: MAIN
37. RECEIVING PATTERN STORAGE TOO SMALL, ARRAY TRUNCATED.
Routine: MAIN
The number of points requested in a receiving pattern exceeds array dimension. Execution will continue, but storage of normalized pattern

will be truncated. This array dimension is 200 in the original NEC deck. Refer to Array Dimension Limitations in Part II to change dimension.

38. ROM2 - - STEP SIZE LIMITED AT Z =

Routine: ROM2

Probably caused by a wire too close to the ground in the Sommerfeld/Norton ground method. Execution continues but results may be inaccurate.

39. SBF - SEGMENT CONNECTION ERROR FOR SEGMENT__.

Routine: SBF

The number of segments at a junction exceeds dimension limit (30), or the connection numbers are not self-consistent.

40. SEGMENT DATA ERROR.

Routine: MAIN

A segment with zero length or zero radius was found. Execution terminated.

41. STEP SIZE LIMITED AT Z = __ __.

Routine: INTX, HFK

The numerical integration to compute interaction matrix elements, using the Romberg variable interval width method, was limited by the minimum allowed step size. Execution will continue. An inaccuracy may occur but is usually not serious. May result from thin wire or wire close to the ground.

42. STORAGE FOR IMPEDANCE NORMALIZATION TOO SMALL, ARRAY TRUNCATED.

Routine: MAIN

The number of frequencies on FR card exceeds the array dimension for impedance normalization. An impedance beyond the limit will not be normalized. Execution continues. The limit is 50 in the original NEC deck. Refer to Array Dimension Limitations in Part II to change limit.

43. SYMMETRY ERROR - NROW, NCOL =

Routine: FBLOCK

Array overflow or program malfunction.

44. TBF - SEGMENT CONNECTION ERROR FOR SEGMENT __.

Routine: TBF

Same as error 39.

45. TRIO - SEGMENT CONNECTION ERROR FOR SEGMENT _.

Routine: TRIO

Same as error 39.

46. WHEN MULTIPLE FREQUENCIES ARE REQUESTED, ONLY ONE NEAR FIELD CARD CAN
BE USED - LAST CARD READ IS USED.

Routine: MAIN

Execution continues.

References

1. Numerical Electromagnetics Code (NEC-1), Part I: NEC Program Description - Theory, to be published, Lawrence Livermore Laboratory, Livermore, CA, 1977 (Content same as NOSC TD 116, Part I).
2. Numerical Electromagnetics Code (NEC-1), Part II: NEC Program Description - Code, to be published, Lawrence Livermore Laboratory, Livermore, CA, 1977 (Content same as NOSC TD 116, Part II).
3. Poggio, A. J. and Adams, R. W., Approximations for Terms Related to the Kernel in Thin-Wire Integral Equations, Lawrence Livermore Laboratory, Livermore, CA, Rept. UCRL-51985, December 19, 1977.
4. Albertsen, N. C., Hansen, J. E., and Jensen, N. E., Computation of Space-Craft Antenna Radiation Patterns, The Technical University of Denmark, Lyngby, Denmark, June 1972.
5. Sengupta, D. L., Electromagnetic and Acoustic Scattering by Simple Shapes, Chapter 10, J. J. Bowman, T. B. A Senior and P. L. E. Uslenghi, Editors, North-Holland Publishing Company, Amsterdam, 1969.